

SECTION B - TABLE OF CONTENTS

Section B Contents:

PRO Euro Hinges.....2-4
 PRO Face Frame Hinges..... 5
 Blum Euro Hinges..... 6-13
 Blum Specialty Euro Hinges..... 14-19
 Blum Baseplates & Accessories.....20-30
 Blum Face Frame Hinges 31-38
 Blum Hinge Machines & Accessories 39-46
 Grass Tiomos Euro Hinges.....47-54
 Grass Tiomos Specialty Euro Hinges 55-61
 Grass Tiomos Baseplates & Accessories 62-68
 Grass Nexis Euro Hinges.....69-72
 Grass Nexis Specialty Hinges.....73-75
 Grass Nexis Baseplates & Accessories76-82
 Grass Face Frame Hinges..... 83-90
 Grass Hinge Machines & Accessories91-92
 Hettich Sensys Euro Hinges 93-97
 Hettich Intermat Euro Hinges98-99
 Hettich Sensys/Intermat Mounting Plates 100-102
 Hettich Face Frame Hinges..... 103-104
 Salice Euro Hinges..... 105-115
 Salice Specialty Euro Hinges..... 116-124
 Salice Baseplates & Accessories.. 125-131
 Salice Face Frame Hinges 132-135
 Sugatsune Stainless Steel Euro Hinges 136



Add Soft-Close to any cabinet door using Grass Nexis or Grass Nexis Impresso hinges!

OUR QUALITY REFLECTS OUR EXPERIENCE

TIOMOS is an elegant hinge system that reflects the quality and detail that Grass puts into every process. **TIOMOS** offers Soft-close technology that is integrated and concealed in the hinge arm for a smooth closing action and three dimensional adjustment for perfect alignment of your cabinet fronts. Various opening angles and specialty application hinges make **TIOMOS** the perfect choice for your fine cabinetry. Experience the quality of **GRASS TIOMOS** hinges.



A
B
C
D
E
F
G
H
I
J
K
L
M
N
O
P
Q
R
S
T
U
V
W
X
Y

NOTE: Some of the items in this section are not available in all markets. Please contact your Würth Louis and Company representative for more information.

A PRO SOFT-CLOSE & SELF-CLOSE EURO HINGES

B
C
D
E
F
G
H
I
J
K
L
M
N
O
P
Q
R
S
T
U
V
W
X
Y



PRO Soft-Close Euro Hinges



- Extra smooth soft-close action
- Soft-close mechanism integrated into hinge arm
- ANSI/BIFMA/KCMA/BHMA approved
- 3 cam adjustable with suitable baseplate (sold separately)
- Boring Pattern: 45mm
- All metal hinge, nickel plated

Item #	Opening	Overlay	Fixing	Closing Type	Box Qty
110° Hinges - Full, Half Overlay, & Inset					
PROH110FOSFT-DWL	110°	Full	Dowel	Soft-close	200
PROH110HOSFT-DWL	110°	Half	Dowel	Soft-close	200
PROH110INSFT-DWL	110°	Inset	Dowel	Soft-close	200
120° Hinges - Full Overlay					
PROH120FOSFT-DWL	120°	Full	Dowel	Soft-close	200
155° Hinges - Full Overlay					
PROH155FOSFT-DWL	155°	Full	Dowel	Soft-close	100



Accessory Items	
Item #	Description
AN203351	35mm Hinge Boring Bit
AN301008	8mm LH Bit, 57mm L



PRO Self-Close Euro Hinges



- ANSI/BIFMA/KCMA/BHMA approved
- 3 cam adjustable with suitable baseplate (sold separately)
- Boring Pattern: 45mm
- All metal hinge, nickel plated

Item #	Opening	Overlay	Fixing	Closing Type	Box Qty
110° Hinges - Full, Half Overlay & Inset					
PROH110FOSLF	110°	Full	Screw-On	Self-close	200
PROH110FOSLF-DWL	110°	Full	Dowel	Self-close	200
PROH110HOSLF-DWL	110°	Half	Dowel	Self-close	200
PROH110INSLF-DWL	110°	Inset	Dowel	Self-close	200
120° Hinges - Full & Half Overlay					
PROH120FOSLF	120°	Full	Screw-On	Self-close	200
PROH120FOSLF-DWL	120°	Full	Dowel	Self-close	200
PROH120HOSLF-DWL	120°	Half	Dowel	Self-close	200
155° Hinges - Full Overlay					
PROH155FOSLF-DWL	155°	Full	Dowel	Self-close	100

PRO EURO HINGE BASEPLATES

PRO Euro Hinge Baseplates

- Work with all PRO Euro Hinges

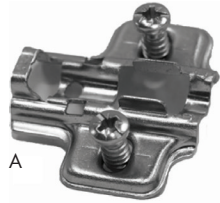

A

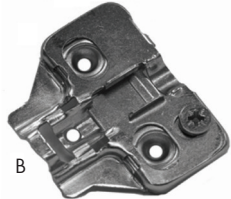

B

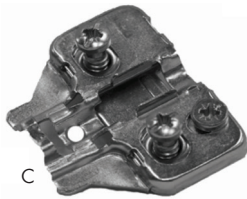

C

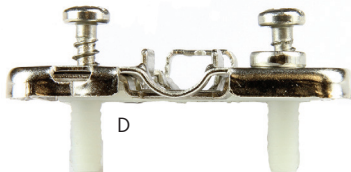

D

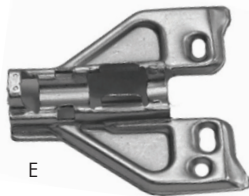

E

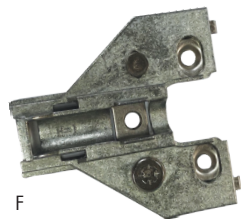

F



Item #	Height	Fixing Type	Box Qty	
Standard One-Piece Wing Mounting Plates - Steel				
A	PROH0PLT-EUR	0mm	Pre-mounted Euro Screws	400
	PROH2PLT-EUR	2mm	Pre-mounted Euro Screws	400
	PROH4PLT-EUR	4mm	Pre-mounted Euro Screws	400
Cam Adjustable Wing Mounting Plates - Steel				
B	PROH0PLT-CAM	0mm	Wood Screw	400
	PROH2PLT-CAM	2mm	Wood Screw	400
	PROH4PLT-CAM	4mm	Wood Screw	400
C	PROH0PLTCAM-EUR	0mm	Pre-mounted Euro Screws	400
	PROH2PLTCAM-EUR	2mm	Pre-mounted Euro Screws	400
	PROH4PLTCAM-EUR	4mm	Pre-mounted Euro Screws	400
D	PROH0PLTCAM-DWL	0mm	5x11mm Split Dowel	400
	PROH2PLTCAM-DWL	2mm	5x11mm Split Dowel	400
	PROH4PLTCAM-DWL	4mm	5x11mm Split Dowel	400
Face Frame Adapter Plates - Steel				
E	PROH1PLTFF	1mm	Wood Screw	400
	PROH3PLTFF	3mm	Wood Screw	400
	PROH6PLTFF	6mm	Wood Screw	400
Face Frame Adapter Plates - Diecast				
F	PROH1PLTFF-CAM	1mm	Wood Screw	400
	PROH3PLTFF-CAM	3mm	Wood Screw	400
	PROH6PLTFF-CAM	6mm	Wood Screw	400

Accessory Items	
Item #	Description
AN608520	Vix Bit, 1/4" Hex Shank, #6 Screw
AN630520	Replacement Bit for above

A
B
C
D
E
F
G
H
I
J
K
L
M
N
O
P
Q
R
S
T
U
V
W
X
Y

A PRO EUROPEAN HINGE OVERLAY CHARTS

B
C
D
E
F
G
H
I
J
K
L
M
N
O
P
Q
R
S
T
U
V
W
X
Y

Full Overlay Hinges

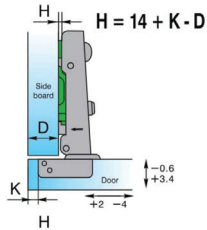
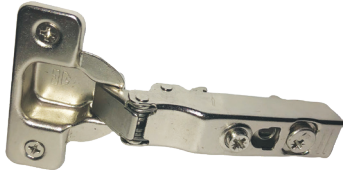

D \ H \ K	3	4	5	6	7
0	17	18	19	20	21
2	15	16	17	18	19
4	13	14	15	16	17

D = Overlay in mm
H = Baseplate height
K = Boring distance

Half Overlay Hinges

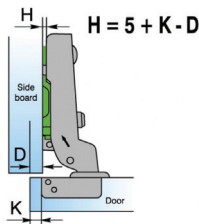

D \ H \ K	3	4	5	6	7
0	8	9	10	11	12
2	6	7	8	9	10
4	4	5	6	7	8

D = Overlay in mm
H = Baseplate height
K = Boring distance

Inset Hinges

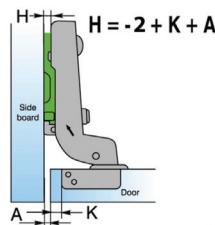

A \ H \ K	3	4	5	6	7
0	1	0	-1	-2	-3
2	3	2	1	0	-1
4	5	4	3	2	1

A = Reveal in mm
H = Baseplate height
K = Boring distance



Screws for Hinges & Baseplates, Flat Head

• Sold by the box



Length x Gauge	Drive	Box Qty	Item #	Quick Code	Box Qty	Item #	Quick Code
Nickel Finish							
1/2" x 6	Phillips	1,000	WUMS6X12FCPNT	L54200	5,000	WUMS6X12FCPNB	L54300
5/8" x 6	Phillips	1,000	WUMS6X58FCPNT	L54375	5,000	WUMS6X58FCPN5B	L54380
3/4" x 6	Phillips	1,000	WUMS6X34FCPNT	L54680	5,000	WUMS6X34FCPNB	L54690
Zinc Finish							
1/2" x 6	Phillips	1,000	WUMS6X12FCPZT	L42100	5,000	WUMS6X12FCPZB	L42150
5/8" x 6	Phillips	1,000	WUMS6X58FCPZT	L42300	5,000	WUMS6X58FCPZ5B	L42390
3/4" x 6	Phillips	1,000	WUMS6X34FCPZT	L42500	5,000	WUMS6X34FCPZB	L43150



Screws for Face Frame Hinges, Modified Truss Head Type 17 Point

• Sold by the box

Length x Gauge	Drive	Box Qty	Item #	Quick Code
3/4" x 8	Phillips	1,000	WUMS8X34MCPNPT	L46300
3/4" x 10	Phillips	1,000	WUMS10X34PPCSNT	L45820

PRO SOFT-CLOSE & SELF-CLOSE FACE FRAME HINGES

A
B
C
D
E
F
G
H
I
J
K
L
M
N
O
P
Q
R
S
T
U
V
W
X
Y

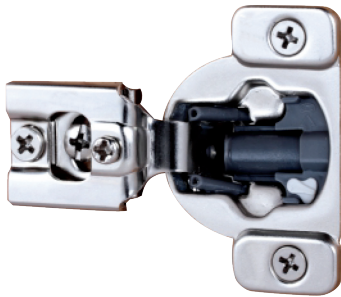

PRO Soft-Close Face Frame Hinges



- Extra smooth soft-close mechanism integrated into hinge cup
- ANSI/BIFMA/KCMA/BHMA approved
- One piece wraparound dowel hinge
- Opening angle: 105°
- 2 Cam Hinge: Height adjustment via elongated hole
- Boring pattern: 45mm
- Depth of hinge cup: 10.5mm

Item #	Overlay	Cam Adjust.	Box Qty
PROH12OLINT-2CAM	1/2"	2	300
PROH114OLINT-2CAM	1-1/4"	2	300



Accessory Items	
Item #	Description
AN203351	35mm Hinge Boring Bit
AN301008	8mm LH Bit, 57mm L



PRO Self-Close Face Frame Hinges



- One piece wraparound dowel hinge
- ANSI/BIFMA/KCMA/BHMA approved
- Opening angle: 105°
- 2 Cam Hinge: Height adjustment via elongated hole
- Boring pattern: 45mm
- Depth of hinge cup: 10.5mm

Item #	Overlay	Cam Adjust.	Box Qty
PROH12OLFF-2CAM	1/2"	2	300
PROH114OLFF-2CAM	1-1/4"	2	300



Accessory Items	
Item #	Description
AN203351	35mm Hinge Boring Bit
AN301008	8mm LH Bit, 57mm L

A BLUM SOFT-CLOSE EURO HINGES



110° CLIP top BLUMOTION Hinges



- BLUMOTION integrated into the hinge cup
- Deactivation switch for small/light doors
- For door thicknesses up to 1" (26mm)
- Overload safety feature
- 86° angle restriction clip available (B70T3553)
- Compatible with existing CLIP mounting plates and hinge arm cover caps

Item #	Opening	Overlay	Fixing	Close Type	Box Qty
B71B355	110°	Full	Screw-On	Soft-Close	250
B71B358	110°	Full	Dowel	Soft-Close	250
B71B359	110°	Full	INSERTA	Soft-Close	250
B71B358E	110°	Full	EXPANDO	Soft-Close	250
B71B365	110°	Half	Screw-On	Soft-Close	250
B71B368	110°	Half	Dowel	Soft-Close	250
B71B369	110°	Half	INSERTA	Soft-Close	250
B71B375	110°	Inset	Screw-On	Soft-Close	250
B71B378	110°	Inset	Dowel	Soft-Close	250
B71B379	110°	Inset	INSERTA	Soft-Close	250

B
C
D
E
F
G
H
I
J
K
L
M
N
O
P
Q
R
S
T
U
V
W
X
Y

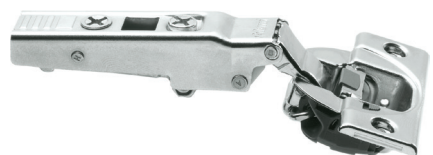

110°+ CLIP top BLUMOTION Hinges



- For door overlays up to 22mm
- BLUMOTION integrated into the hinge cup
- Deactivation switch for small/light doors
- For door thicknesses up to 1" (26mm)
- Overload safety feature
- 86° angle restriction clip available (B70T3553)
- Compatible with existing CLIP mounting plates and hinge arm cover caps

Item #	Opening	Overlay	Fixing	Close Type	Box Qty
B73B355	110°	Full	Screw-On	Soft-Close	250
B73B358	110°	Full	Dowel	Soft-Close	250
B73B359	110°	Full	INSERTA	Soft-Close	250
B73B358E	110°	Full	EXPANDO	Soft-Close	250

BLUM SOFT-CLOSE EURO HINGES



95° CLIP top BLUMOTION Thick Door Hinges



- BLUMOTION integrated into the hinge cup
- Deactivation switch for small/light doors
- For door thicknesses up to 1-3/16" (30mm)
- Overload safety feature
- Compatible with existing CLIP mounting plates and hinge arm cover caps

Item #	Opening	Overlay	Fixing	Close Type	Box Qty
B71B955	95°	Full	Screw-On	Soft-close	250
B71B958	95°	Full	Dowel	Soft-close	250
B71B959	95°	Full	INSERTA	Soft-close	250
B71B965	95°	Half	Screw-On	Soft-close	50
B71B968	95°	Half	Dowel	Soft-close	50
B71B969	95°	Half	INSERTA	Soft-close	50
B71B975	95°	Inset	Screw-On	Soft-close	50
B71B978	95°	Inset	Dowel	Soft-close	50
B71B979	95°	Inset	INSERTA	Soft-close	50



110° CLIP top BLUMOTION Diagonal 45° II



- BLUMOTION integrated into the hinge cup
- Deactivation switch for small/light doors
- For door thicknesses up to 3/4" (19mm)
- Overload safety feature
- Compatible with existing CLIP mounting plates and hinge arm cover caps

Item #	Opening	Overlay	Fixing	Close Type	Box Qty
B79B3598	110°	Diagonal 45°	INSERTA	Soft-close	50

A BLUM ZERO PROTRUSION EURO HINGES

B
C
D
E
F
G
H
I
J
K
L
M
N
O
P
Q
R
S
T
U
V
W
X
Y

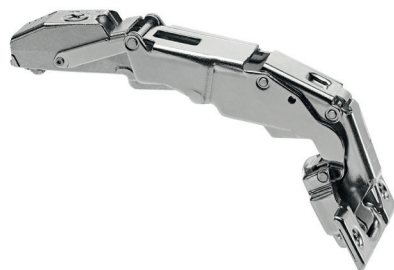

155° CLIP top and CLIP top BLUMOTION Zero Protrusion Hinges



- For use in cabinets with interior roll-outs
- Three-dimensional adjustment
- Available with INSERTA attachment
- For door thicknesses up to 15/16" (24mm)
- All metal hinge, nickel-plated

Item #	Opening	Overlay	Fixing	Close Type	Box Qty
B71T755	155°	Full	Screw-On	Self-close	125
B71B755	155°	Full	Screw-On	Soft-close	125
B71B758	155°	Full	Dowel	Soft-close	125
B71T759	155°	Full	INSERTA	Self-close	125
B71B759	155°	Full	INSERTA	Soft-close	125
B71T765	155°	Half	Screw-On	Self-close	25
B71B765	155°	Half	Screw-On	Soft-close	25
B71B769	155°	Half	INSERTA	Soft-close	25

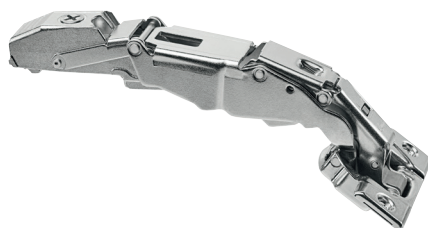

125° CLIP top BLUMOTION Zero Protrusion Hinges for Thicker Doors



- Zero protrusion hinge for thicker doors
- For use in cabinets with interior roll-outs
- Three-dimensional adjustment
- For door thicknesses up to 1-3/16" (30mm)
- All metal hinge, nickel-plated

Item #	Opening	Overlay	Fixing	Close Type	Box Qty
B71B755D	125°	Full	Screw-On	Soft-close	25
B71B758D	125°	Full	Dowel	Soft-close	25

BLUM SOFT-CLOSE SPECIALTY EURO HINGES

A
B
C
D
E
F
G
H
I
J
K
L
M
N
O
P
Q
R
S
T
U
V
W
X
Y



95° CLIP top BLUMOTION Inset Blind Corner Hinges



- BLUMOTION integrated into the hinge cup
- Deactivation switch for small/light doors
- For door thicknesses up to 15/16" (24mm)
- Overload safety feature
- Boring distance range 3mm to 7mm
- Compatible with existing CLIP mounting plates and hinge arm cover caps

Item #	Opening	Overlay	Fixing	Close Type	Box Qty
B79B955	95°	Inset	Screw-On	Soft-close	50
B79B958	95°	Inset	Dowel	Soft-close	50
B79B959	95°	Inset	INSERTA	Soft-close	50

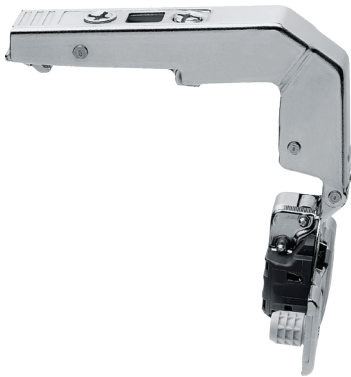

95° CLIP top BLUMOTION Overlay Blind Corner Hinges



- BLUMOTION integrated into the hinge cup
- Deactivation switch for small/light doors
- For door thicknesses up to 15/16" (24mm)
- Overload safety feature
- Boring distance range 3mm to 7mm
- Compatible with existing CLIP mounting plates and hinge arm cover caps

Item #	Opening	Overlay	Fixing	Close Type	Box Qty
B79B998	95°	Overlay	Dowel	Soft-close	50



95° CLIP top BLUMOTION Narrow Aluminum Door Hinges



- BLUMOTION integrated into the hinge cup
- Deactivation switch for small/light doors
- For door thicknesses up to 7/8" (22mm)
- Overload safety feature
- Compatible with existing CLIP mounting plates and hinge arm cover caps

Item #	Opening	Overlay	Fixing	Close Type	Box Qty
B71B950A	95°	Full	Dowel	Soft-close	50

A BLUM EURO HINGES

B
C
D
E
F
G
H
I
J
K
L
M
N
O
P
Q
R
S
T
U
V
W
X
Y



100° CLIP Hinges



- Three-dimensional adjustment
- Available with INSERTA attachment
- For door thicknesses up to 15/16" (24mm)
- All metal hinge, nickel-plated
- Add-on BLUMOTION soft close available

Item #	Opening	Overlay	Fixing	Close Type	Box Qty
B71M255	100°	Full	Screw-On	Self-close	250
B70M255	100°	Full	Screw-On	Free Swing	50
B71M258	100°	Full	Dowel	Self-close	250
B70M258	100°	Full	Dowel	Free Swing	50
B71M258E	100°	Full	EXPANDO	Self-close	250
B71M259	100°	Full	INSERTA	Self-close	250
B71M265	100°	Half	Screw-On	Self-close	250
B70M265	100°	Half	Screw-On	Free Swing	50
B71M268	100°	Half	Dowel	Self-close	250
B71M2690B	100°	Half	INSERTA	Self-close	250
B71M275	100°	Inset	Screw-On	Self-close	250
B70M275	100°	Inset	Screw-On	Free Swing	50
B71M278	100°	Inset	Dowel	Self-close	250
B70M278	100°	Inset	Dowel	Free Swing	50
B71M279	100°	Inset	INSERTA	Self-close	250



107° CLIP top Hinges



- Three-dimensional adjustment
- Available with INSERTA attachment
- For door thicknesses up to 3/4" (19mm)
- 86° angle restriction clip available (B74.1103)
- All metal hinge, nickel-plated
- Add-on BLUMOTION soft close available

Item #	Opening	Overlay	Fixing	Close Type	Box Qty
B75T155	107°	Full	Screw-On	Self-close	250
B75T158	107°	Full	Dowel	Self-close	250
B75T159	107°	Full	INSERTA	Self-close	250

BLUM CLIP TOP EURO HINGES



110° CLIP top Hinges

- Three-dimensional adjustment
- INSERTA lever expands in 8mm holes
- 86° angle restriction clip available (B70T3553)
- All metal hinge, nickel-plated
- Add-on BLUMOTION soft close available
- Available with INSERTA attachment
- For door thicknesses up to 1" (26mm)



Item #	Opening	Overlay	Fixing	Close Type	Box Qty
B71T355	110°	Full	Screw-On	Self-close	250
B70T355	110°	Full	Screw-On	Free Swing	50
B71T358	110°	Full	Dowel	Self-close	250
B70T358	110°	Full	Dowel	Free Swing	50
B71T358E	110°	Full	EXPANDO	Self-close	250
B71T359	110°	Full	INSERTA	Self-close	250
B70T359	110°	Full	INSERTA	Free Swing	50
B71T365	110°	Half	Screw-On	Self-close	50
B70T365	110°	Half	Screw-On	Free Swing	50
B71T368	110°	Half	Dowel	Self-close	50
B71T369	110°	Half	INSERTA	Self-close	50
B70T369	110°	Half	INSERTA	Free Swing	50
B71T375	110°	Inset	Screw-On	Self-close	50
B70T375	110°	Inset	Screw-On	Free Swing	50
B71T378	110°	Inset	Dowel	Self-close	50
B71T379	110°	Inset	INSERTA	Self-close	50



110°+ CLIP top Hinges

- For larger overlays (22mm maximum)
- Available with INSERTA attachment
- For door thicknesses up to 1" (26mm)
- 86° angle restriction clip available (B70T3553)
- All metal hinge, nickel-plated
- Add-on BLUMOTION soft close available
- Three-dimensional adjustment
- INSERTA lever expands in 8mm holes



Item #	Opening	Overlay	Fixing	Close Type	Box Qty
B73T355	110°+	Full	Screw-on	Self-close	250
B72T355	110°+	Full	Screw-on	Free Swing	50
B73T358	110°+	Full	Dowel	Self-close	250
B72T358	110°+	Full	Dowel	Free Swing	50
B73T358E	110°+	Full	EXPANDO	Self-close	250
B73T359	110°+	Full	INSERTA	Self-close	250
B72T359	110°+	Full	INSERTA	Free Swing	50

A BLUM CLIP TOP EURO HINGES

B
C
D
E
F
G
H
I
J
K
L
M
N
O
P
Q
R
S
T
U
V
W
X
Y

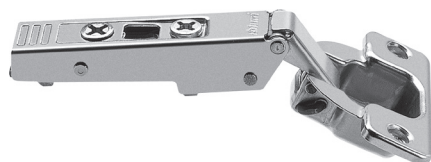

120° CLIP top Hinges

- Three-dimensional adjustment
- Available with INSERTA attachment
- For door thicknesses up to 7/8" (22mm)
- All metal hinge, nickel-plated
- Add-on BLUMOTION soft close available



Item #	Opening	Overlay	Fixing	Close Type	Box Qty
B71T555	120°	Full	Screw-On	Self-Close	250
B71T558	120°	Full	Dowel	Self-Close	250
B71T558E	120°	Full	EXPANDO	Self-Close	250
B71T559	120°	Full	INSERTA	Self-Close	250
B71T565	120°	Half	Screw-On	Self-Close	50
B71T568	120°	Half	Dowel	Self-Close	50
B71T569	120°	Half	INSERTA	Self-Close	50



120° + CLIP top Hinges

- For larger overlays (21mm maximum)
- Three-dimensional adjustment
- Available with INSERTA attachment
- For door thicknesses up to 7/8" (22mm)
- All metal hinge, nickel-plated
- Add-on BLUMOTION soft close available



Item #	Opening	Overlay	Fixing	Close Type	Box Qty
B73T555	120°	Full	Screw-On	Self-Close	250
B73T558	120°	Full	Dowel	Self-Close	250
B73T559	120°	Full	INSERTA	Self-Close	250
B73T558E	120°	Full	EXPANDO	Self-Close	250

BLUM CLIP TOP EURO HINGES



95° CLIP top Thick Door Hinges



- Three-dimensional adjustment
- Available with INSERTA attachment
- For door thicknesses up to 1-3/16" (30mm)
- All metal hinge, nickel-plated
- Add-on BLUMOTION soft close available

Item #	Opening	Overlay	Fixing	Close Type	Box Qty
B71T955	95°	Full	Screw-on	Self-close	250
B70T955	95°	Full	Screw-on	Free Swing	50
B71T958	95°	Full	Dowel	Self-close	250
B70T958	95°	Full	Dowel	Free Swing	50
B71T959	95°	Full	INSERTA	Self-close	250
B71T965	95°	Half	Screw-on	Self-close	50
B70T965	95°	Half	Screw-on	Free Swing	50
B71T968	95°	Half	Dowel	Self-close	50
B71T969	95°	Half	INSERTA	Self-close	50
B71T975	95°	Inset	Screw-on	Self-close	50
B70T975	95°	Inset	Screw-on	Free Swing	50
B71T978	95°	Inset	Dowel	Self-close	50
B71T979	95°	Inset	INSERTA	Self-close	50

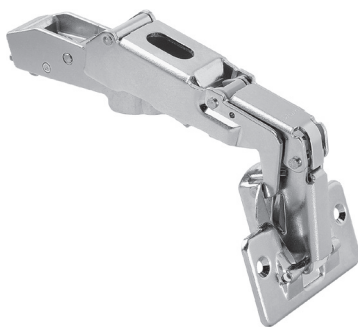

170° CLIP top Hinges



- Three-dimensional adjustment
- Available with INSERTA attachment
- For door thicknesses up to 15/16" (24mm)
- 130° angle restriction clip available (B70.6103)
- All metal hinge, nickel-plated
- Add-on BLUMOTION soft close available

Item #	Opening	Overlay	Fixing	Close Type	Box Qty
B71T655	170°	Full	Screw-On	Self-Close	125
B70T655	170°	Full	Screw-On	Free Swing	25
B71T658	170°	Full	Dowel	Self-Close	125
B71T654	170°	Full	INSERTA	Self-Close	125
B70T654	170°	Full	INSERTA	Free Swing	25
B71T665	170°	Half	Screw-On	Self-Close	25
B70T665	170°	Half	Screw-On	Free Swing	25
B71T668	170°	Half	Dowel	Self-Close	25
B71T664	170°	Half	INSERTA	Self-Close	25

A
B
C
D
E
F
G
H
I
J
K
L
M
N
O
P
Q
R
S
T
U
V
W
X
Y

A BLUM SPECIALTY EURO HINGES

B
C
D
E
F
G
H
I
J
K
L
M
N
O
P
Q
R
S
T
U
V
W
X
Y



60° CLIP top Bi-Fold Hinges



- Spiral tech side adjustment for door gap
- Spiral tech depth adjustment for in/out
- Four dimensional adjustment
- All metal hinge, nickel-plated

Item #	Opening	Overlay	Fixing	Close Type	Box Qty
B79T850	60°	Bi-Fold	Screw-On	Self-close	25
B79T853	60°	Bi-Fold	Dowel	Self-close	25

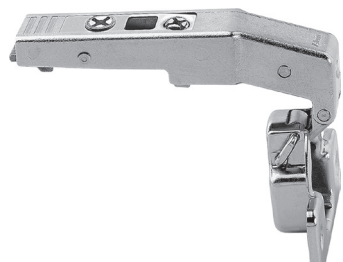

95° CLIP top Inset Blind Corner Hinges



- Three-dimensional adjustment
- Available with INSERTA attachment
- For door thicknesses up to 15/16" (24mm)
- All metal hinge, nickel-plated

Item #	Opening	Overlay	Fixing	Close Type	Box Qty
B79T955	95°	Inset Blind Corner	Screw-On	Self-close	50
B79T958	95°	Inset Blind Corner	Dowel	Self-close	50
B79T959	95°	Inset Blind Corner	INSERTA	Self-close	50



95° CLIP top Overlay Blind Corner Hinges



- Three-dimensional adjustment
- Available with INSERTA attachment
- For door thicknesses up to 15/16" (24mm)
- All metal hinge, nickel-plated

Item #	Opening	Overlay	Fixing	Close Type	Box Qty
B79T999.37	95°	Overlay Blind Corner	INSERTA	Self-close	50



120° CLIP top Aluminum Door Hinge for BLUMOTION



- For use with BLUMOTION 973A
- Three-dimensional adjustment
- For door thicknesses up to 7/8" (22mm)
- All metal hinge, nickel-plated

Item #	Opening	Overlay	Fixing	Close Type	Box Qty
B73T550AB	120°	Full	Screw-On	Self-close	50

BLUM SPECIALTY EURO HINGES

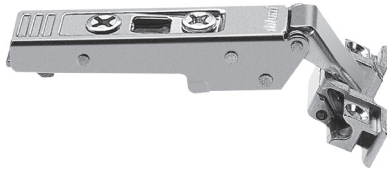

120° CLIP top Aluminum Door Hinge



- Not for use with BLUMOTION 973A
- For door thicknesses up to 7/8" (22mm)

Item #	Opening	Overlay	Fixing	Close Type	Box Qty
B73T550A	120°	Full	Screw-On	Self-close	50
B72T550A.TL	120°	Full	Screw-On	Free Swing	20

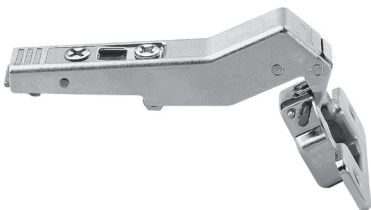

110° CLIP top Diagonal 45° Hinges



- For door thicknesses up to 3/4" (19mm)
- All metal hinge, nickel-plated

Item #	Opening	Overlay	Fixing	Close Type	Box Qty
B79T555	110°	Diagonal 45°	Screw-On	Self-close	50
B79T558	110°	Diagonal 45°	Dowel	Self-close	50
B79T559	110°	Diagonal 45°	INSERTA	Self-close	50



95° CLIP top Mini Hinges



- For small doors or doors with small frames
- Side adjustment of +0.5mm to -3.5mm
- 26mm drill bit required (1" cannot be used)
- For door thicknesses up to 1" (26mm)

Item #	Opening	Overlay	Fixing	Close Type	Box Qty
B71T055	95°	Full	Screw-On	Self-close	50
B71T065	95°	Half	Screw-On	Self-close	50
B71T075	95°	Inset	Screw-On	Self-close	50



95° CLIP top Glass Door Hinges



- For glass thickness of 4.5mm to 7mm
- Side adjustment of +0.5mm to -3.5mm
- Fixing screws included
- 26mm drill bit required (1" cannot be used)

Item #	Opening	Overlay	Fixing	Close Type	Box Qty
B75T410	95°	Full	Screw-On	Self-close	50
B75T420	95°	Half	Screw-On	Self-close	50
B75T430	95°	Inset	Screw-On	Self-close	50

A
B
C
D
E
F
G
H
I
J
K
L
M
N
O
P
Q
R
S
T
U
V
W
X
Y

A BLUM ANGLED HINGES

B Blum Angled CLIP top BLUMOTION & CLIP top Hinges

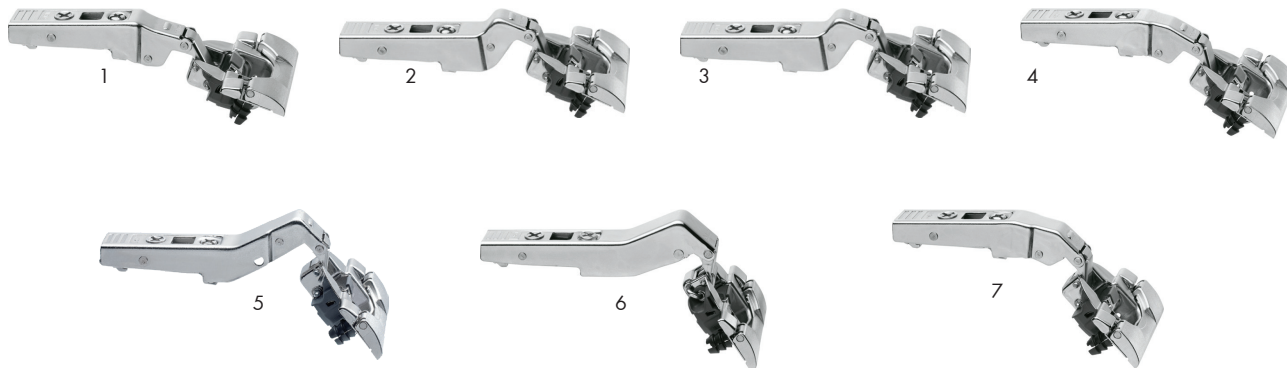

Positive Angle Hinges

	Item #	Degree	Fixing	Close Type	Box Qty
1	B79B9494	+15°	INSERTA	CLIP top BLUMOTION	50
	B79A9494T	+15°	INSERTA	CLIP top	50
2	B79B9595	+20°	INSERTA	CLIP top BLUMOTION	50
	B79A9595T	+20°	INSERTA	CLIP top	50
3	B79B9596	+30° II	INSERTA	CLIP top BLUMOTION	50
	B79A9596T	+30° II	INSERTA	CLIP top	50
4	B79B9496	+30° III	INSERTA	CLIP top BLUMOTION	50
	B79A9496T	+30° III	INSERTA	CLIP top	50
5	B79B9698	+45° I	INSERTA	CLIP top BLUMOTION	50
	B79A9698T	+45° I	INSERTA	CLIP top	50
6	B79B3598	+45° II	INSERTA	CLIP top BLUMOTION	50
	B79T559	+45° II	INSERTA	CLIP top	50
7	B79B9498	+45° III	INSERTA	CLIP top BLUMOTION	50
	B79A9498T	+45° III	INSERTA	CLIP top	50

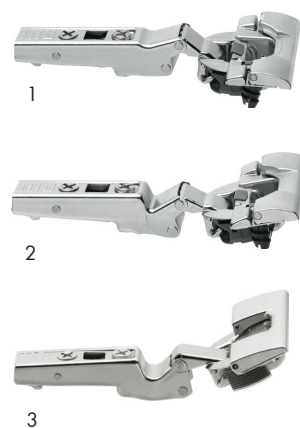

Negative Angle Hinges

	Item #	Degree	Fixing	Close Type	Box Qty
1	B79B3493	-15°	INSERTA	CLIP top BLUMOTION	50
	B79A5493T	-15°	INSERTA	CLIP top	50
2	B79B3491	-30°	INSERTA	CLIP top BLUMOTION	50
	B79A5491T	-30°	INSERTA	CLIP top	50
3	B79B3490	-45°	INSERTA	CLIP top BLUMOTION	50
	B79A5490T	-45°	INSERTA	CLIP top	50

BLUM ANGLED HINGES



Standard Thick Door Hinges Used in Angled Applications

	Item #	Degree	Overlay	Fixing	Closing Type	Box Qty
1	B71B959	95°	Full	INSERTA	CLIP top BLUMOTION	250
	B71T959	95°	Full	INSERTA	CLIP top	250
2	B71B969	95°	Half	INSERTA	CLIP top BLUMOTION	50
	B71T969	95°	Half	INSERTA	CLIP top	50
3	B71B979	95°	Inset	INSERTA	CLIP top BLUMOTION	50
	B71T979	95°	Inset	INSERTA	CLIP top	50

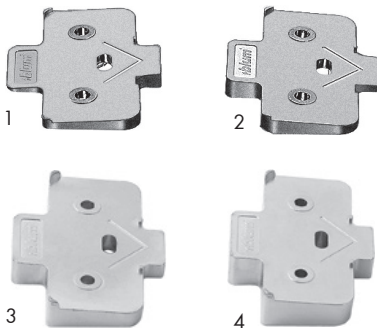

Angled Spacer Wedges for Positive and Negative Angled Hinges

	Item #	Thickness	Degree	Box Qty
1	B171A5500	2mm	-5°	50
2	B171A5010	4mm	+5°	50
3	B171A5040	5mm	+5°	50
4	B171A5070	7mm	+5°	50

A
B
C
D
E
F
G
H
I
J
K
L
M
N
O
P
Q
R
S
T
U
V
W
X
Y

A **BLUM ONYX BLACK EURO HINGES**

B
C
D
E
F
G
H
I
J
K
L
M
N
O
P
Q
R
S
T
U
V
W
X
Y

Blum Onyx Black Euro Hinges



- Surface finish for better integration into darker cabinets
- High quality mounting plates with convenient cam height adjustment



110° CLIP top BLUMOTION Hinges					
Item #	Opening	Overlay	Fixing	Close Type	Box Qty
B71B355-BK	110°	Full	Screw-On	Soft-close	250
B71B358-BK	110°	Full	Dowel	Soft-close	250
B71B359-BK	110°	Full	INSERTA	Soft-close	250
B71B365-BK	110°	Half	Screw-On	Soft-close	250
B71B369-BK	110°	Half	INSERTA	Soft-close	250
B71B375-BK	110°	Inset	Screw-On	Soft-close	250
B71B379-BK	110°	Inset	INSERTA	Soft-close	250



110°+ CLIP top BLUMOTION Hinges					
Item #	Opening	Overlay	Fixing	Close Type	Box Qty
B73B355-BK	110°+	Full	Screw-On	Soft-close	250
B73B359-BK	110°+	Full	INSERTA	Soft-close	250



95° CLIP top BLUMOTION Thick Door Hinges					
Item #	Opening	Overlay	Fixing	Close Type	Box Qty
B71B955-BK	95°	Full	Screw-On	Soft-close	250
B71B958-BK	95°	Full	Dowel	Soft-close	250
B71B959-BK	95°	Full	INSERTA	Soft-close	250
B71B965-BK	95°	Half	Screw-On	Soft-close	50
B71B969-BK	95°	Half	INSERTA	Soft-close	50
B71B975-BK	95°	Inset	Screw-On	Soft-close	50
B71B979-BK	95°	Inset	INSERTA	Soft-close	50



155° CLIP top BLUMOTION Zero Protrusion Hinges					
Item #	Opening	Overlay	Fixing	Close Type	Box Qty
B71B755-BK	155°	Full	Screw-On	Soft-close	125
B71B758-BK	155°	Full	Dowel	Soft-close	125
B71B759-BK	155°	Full	INSERTA	Soft-close	125
B71B769-BK	155°	Half	INSERTA	Soft-close	25

BLUM ONYX BLACK EURO HINGES

Blum Onyx Black Euro Hinges

- Surface finish for better integration into darker cabinets
- High quality mounting plates with convenient cam height adjustment



CLIP top BLUMOTION Specialty Hinges

Item #	Opening	Hinge Type	Fixing	Close Type	Box Qty
B79B955-BK	95°	Inset Blind Corner	Screw-On	Soft-close	50
1 B79B958-BK	95°	Inset Blind Corner	Dowel	Soft-close	50
B79B959-BK	95°	Inset Blind Corner	INSERTA	Soft-close	50
2 B79B9698-BK	95°	+45° I Angled	INSERTA	Soft-close	50
3 B79B3598-BK	110°	+45° II Angled	INSERTA	Soft-close	50

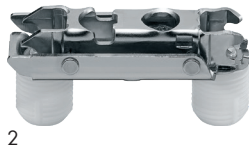
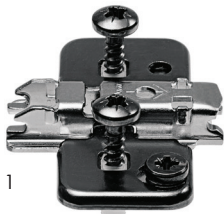

CLIP Mounting Plates

Item #	Height	Plate Type	Fixing Type	Box Qty
1 B174H7100E-BK	0mm	Wing	EXPANDO	500
2 B175H3100-BK	0mm	Inline	Screw-On	500

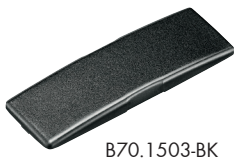

95° CLIP top BLUMOTION Thick Door Hinges

Item #	Description	Box Qty
B70.1503-BK	Blank Arm Cover Cap for Full Overlay Hinges	1,000
B70.1553-BK	Blank Arm Cover Cap for Angled Hinges	1,000
B70.4503-BK	Hinge Arm Cover Cap for Zero Protrusion Hinges	1,000
B70T3504-BK	Blank Cup Cover Cap for 110° Hinges	1,000
B70T7504-BK	Blank Cup Cover Cap for 125° & 155° Zero Protrusion Hinges	1,000

A BLUM CLIP MOUNTING PLATES

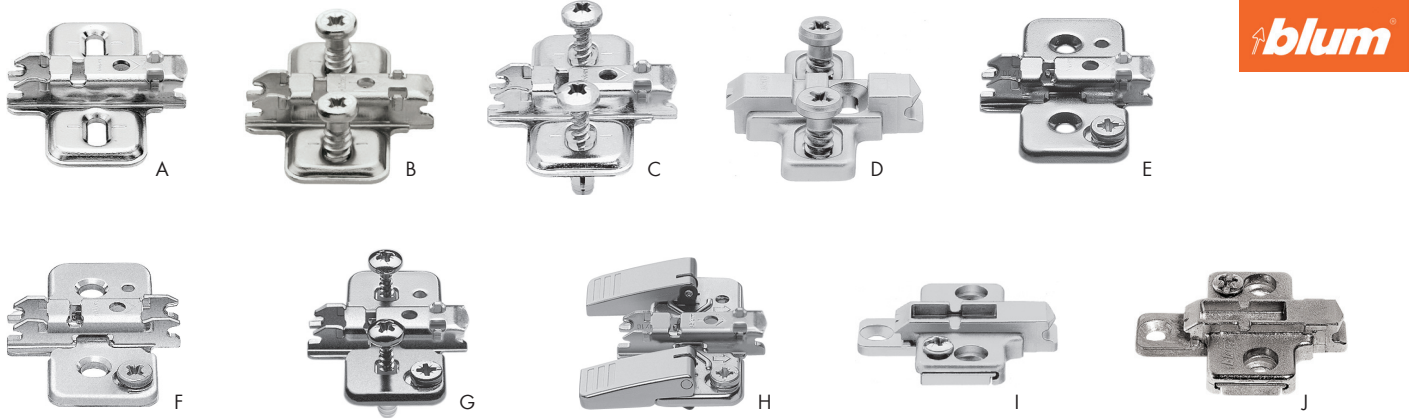

	Item #	Height	Fixing Type	Material	Box Qty
Standard One-Piece Wing Mounting Plates					
A	B173L610	0mm	Wood Screw	Stamped Steel	500
	B173L613	3mm	Wood Screw	Stamped Steel	500
B	B173L810	0mm	Pre-mounted 5mm System Screws	Stamped Steel	500
	B173L813	3mm	Pre-mounted 5mm System Screws	Stamped Steel	500
C	B174E610	0mm	EXPANDO	Stamped Steel	500
	B174E610Z	0mm	EXPANDO (twin application)	Stamped Steel	500
D	B175L810	0mm	Pre-mounted 5mm System Screws	Zinc Die-cast	500
	B175L813	3mm	Pre-mounted 5mm System Screws	Zinc Die-cast	500
	B175L819	9mm	Pre-mounted 5mm System Screws	Zinc Die-cast	250
Cam Adjustable Wing Mounting Plates					
E	B173H7100	0mm	Wood Screw	Stamped Steel	500
	B173H7130	3mm	Wood Screw	Stamped Steel	50
F	B173H910	0mm	Wood Screw or System Screw	Stamped Steel	500
	B173H9130	3mm	Wood Screw or System Screw	Stamped Steel	500
G	B174H7100E	0mm	EXPANDO	Stamped Steel	500
	B174H7130E	3mm	EXPANDO	Stamped Steel	500
	B174H710ZE	0mm	EXPANDO (twin application)	Stamped Steel	500
H	B174H7100I	0mm	INSERTA	Stamped Steel	250
	B174H7130I	3mm	INSERTA	Stamped Steel	50
Standard Two-Piece Wing Mounting Plates					
I	B175H710	0mm	Wood Screw	Zinc Die-cast	500
	B175H713	3mm	Wood Screw	Zinc Die-cast	50
	B175H719	9mm	Wood Screw	Zinc Die-cast	250
J	B175H910	0mm	Wood Screw or System Screw	Zinc Die-cast	500
	B175H913	3mm	Wood Screw or System Screw	Zinc Die-cast	50
	B175H916	6mm	Wood Screw or System Screw	Zinc Die-cast	50
	B175H919	9mm	Wood Screw or System Screw	Zinc Die-cast	250
	B175H919.22	18mm	Wood Screw or System Screw	Zinc Die-cast	250

BLUM CLIP MOUNTING PLATES



A



B



C

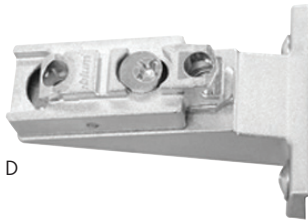

D

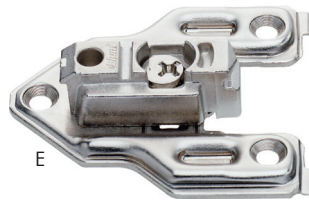

E

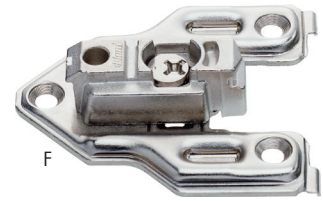

F

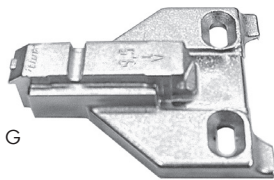

G

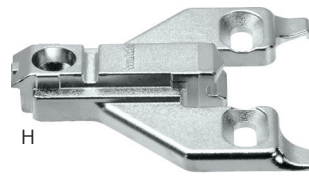

H

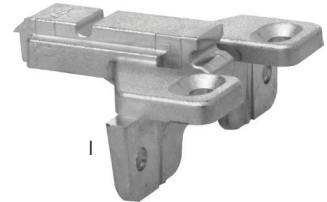

I

	Item #	Height	Fixing Type	Material	Box Qty
Standard One-Piece Wing Mounting Plates					
A	B175H3100	0mm	Wood Screw	Stamped Steel	500
B	B177H3100	0mm	Dowel	Stamped Steel	500
C	B177H3100E	0mm	EXPANDO	Stamped Steel	500
	B177H3130E	3mm	EXPANDO	Stamped Steel	500
Inset Face Frame Adapter					
D	B175H5030.21	9mm	Truss Head Screw	Zinc Die-cast	250
Face Frame Adapter Plates - Use #7 x 3/4" Wood Screws					
E	B175H6000	0mm	Cam Adjustable Center Mount	Zinc Die-cast	250
	B175H6030	3mm	Cam Adjustable Center Mount	Zinc Die-cast	250
	B175H6040	4.5mm	Cam Adjustable Center Mount	Zinc Die-cast	250
	B175H6060	6mm	Cam Adjustable Center Mount	Zinc Die-cast	250
F	B175H6600	0mm	Cam Adjustable Off-Center Mount	Zinc Die-cast	250
G	B175L6030.21	3mm	Center Mount	Zinc Die-cast	500
H	B175L6600.22	0mm	Off-Center Mount	Zinc Die-cast	500
	B175L6630.22	3mm	Off-Center Mount	Zinc Die-cast	500
	B175L6660.22	6mm	Off-Center Mount	Zinc Die-cast	250
I	B175L6600.24	0mm	With Flange	Zinc Die-cast	250



Accessory Items	
Item #	Description
AN608520	Vix Bit, 1/4" Hex Shank, #6 Screw
AN630520	Replacement Bit for above

A
B
C
D
E
F
G
H
I
J
K
L
M
N
O
P
Q
R
S
T
U
V
W
X
Y

A BLUM CAM ADJUSTABLE MOUNTING PLATES

B Blum CAM Adjustable Thick Mounting Plates



- Can be used on both face frame and frameless cabinet applications
- Five plates come in heights that help avoid blocking out in inset applications, by matching the recess behind the face frame
- Cam height adjustment of +/- 2mm
- Steel, nickel-plated with zinc adapter
- Attached with #7 x 5/8" wood screws or 5mm x 13mm euro screws

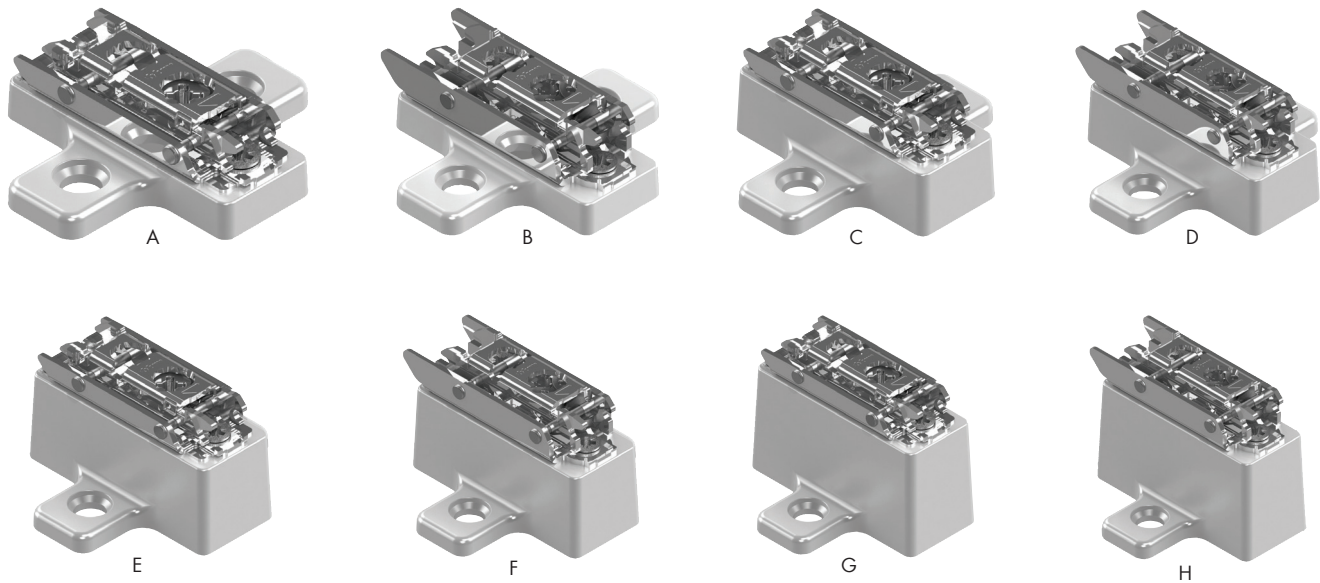

Sample Application

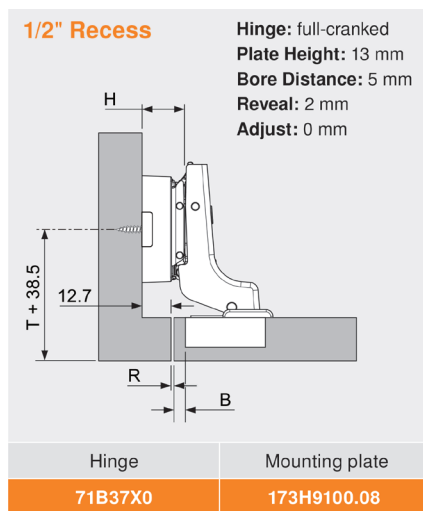

	Item #	Height	Inset Recess	Box Qty
A	B173H9100.04	6mm	1/4"	250
B	B173H9130.06	9mm	3/8"	250
C	B173H9100.08	13mm	1/2"	250
D	B173H9130.10	16mm	5/8"	250
E	B173H9100.12	19mm	3/4"	250
F	B173H9130.14	22mm	7/8"	250
G	B173H9100.16	25mm	1"	250
H	B173H9130.18	29mm	1-1/8"	250

BLUM EURO HINGE ACCESSORIES

Hinge Arm Cover Caps



B70.1503



B70.1503.BP
(Blum logo)



B70.1663



B70.4503



B80.6507



B90M2103BK



Steel Item #	Nylon Item #	Overlays	For Use With	Box Qty
B70.1503	B90M2103BK	Full Overlay	100°, 107°, 110°, 110°+, 120°, 120°+, Thick Door, Bi-Fold, Diagonal 45°, Blind Corner, and Narrow Aluminum Door Hinges	1,000
B70.1503.BP	-	Full Overlay with Embossed Blum Logo		1,000
B70.1663	-	Inset		1,000
B70.4503	-	All Overlays	125°/155° Hinges	1,000
B80.6507	-	All Overlays	170° Hinges	1,000



Hinge Cup Spacer

- 1.5mm spacer for use under the hinge cup
- Use to retrofit existing doors with a cup depth less than 13mm
- Non-stackable
- Gray nylon
- Not for use with INSERTA hinges

Item #	Box Qty
B70T3507.21	250



Hinge Cup Cover Cap for BLUMOTION Hinges

- For use with CLIP top BLUMOTION hinges
- Suitable for screw-on, dowel and EXPANDO hinge cups
- Can also be used with CLIP top 110° and 110°+ hinges
- Steel, nickel-plated

Item #	Box Qty
B70T3504	1,000

A BLUM EURO HINGE ACCESSORIES

B
C
D
E
F
G
H
I
J
K
L
M
N
O
P
Q
R
S
T
U
V
W
X
Y



Hinge Cover Cap for CLIP top Hinges



- For use with CLIP top hinges only
- Suitable for screw-on, dowel and EXPANDO hinge cups for CLIP top 107°, 120°, 120°+, thick door and blind corner hinges
- Clip on attachment/removal
- Steel, nickel-plated

Item #	Box Qty
B70T1504	1,000



Hinge Cover Cap for Zero Protrusion Hinges



- For use with Zero Protrusion CLIP top and CLIP top BLUMOTION hinges
- Clip on attachment/removal
- Steel, nickel-plated

Item #	Finish	Box Qty
B70T7504	Nickel	1,000
B70T7504-BK	Black	1,000



3mm Spacer



- Reduces overlays by 3mm
- Mounts under CLIP wing mounting plates
- Stackable
- Gray nylon

Item #	Box Qty
B181.6130	50

BLUM EURO HINGE ANGLE RESTRICTION CLIPS

A
B
C
D
E
F
G
H
I
J
K
L
M
N
O
P
Q
R
S
T
U
V
W
X
Y



Angle Restriction Clip for 107° Hinges

- Reduces opening angle of the CLIP top and CLIP 107° hinges to 86°
- For use with CLIP top and CLIP 107° hinges only
- Installs quickly, easily and tool-free
- Non-removable
- Black nylon



Item #	Box Qty
B74.1103	250

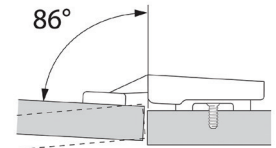

Angle Restriction Clip for 110° Hinges

- Reduces opening angle of the CLIP top 110° and 110°+ hinges to 86°
- For use with CLIP top 110° and 110°+ hinges only
- Installs quickly, easily and tool-free either before or after the hinge has been installed
- Black nylon



Item #	Box Qty
B70T3553	250



Angle Restriction Clip for 170° Hinges

- Reduces opening angle of the CLIP top 170° hinge to 130°
- Required for special applications of the 170° hinge
- Installs quickly, easily and tool-free
- Black nylon



Item #	Box Qty
B70.6103	250

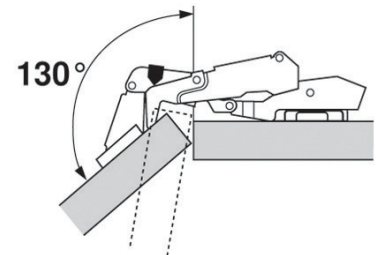

Angle Restriction Clips for Zero Protrusion Hinges

- Reduces opening angle of CLIP top 155° hinge to 110° or 92°
- For use with 155°/125° hinges only
- Installs quickly, easily and tool-free
- Gray nylon



Item #	Description	Box Qty
B70T7553	110° for 155° / 92° for 125°	250
B70T7553.09	92° for 155°	250

A BLUMOTION SOFT-CLOSE DEVICES FOR BLUM EURO HINGES

B
C
D
E
F
G
H
I
J
K
L
M
N
O
P
Q
R
S
T
U
V
W
X
Y

BLUM 973A BLUMOTION for CLIP Hinges



- Soft-closing feature for CLIP top and CLIP hinges
- Offers the same quality of motion as drawer systems with BLUMOTION
- Automatically adjusts to the closing force of the door
- Simple attachment to the hinge arm
- Nickel-plated steel and gray nylon



For Full Overlay Hinges		
For Use With	Item #	Box Qty
CLIP top 107°, CLIP top 110°, CLIP top 110°+, CLIP top 120°, CLIP top 120°+, CLIP top 95° thick door, CLIP top 120° aluminum door, CLIP 100°	B973A0500.01	500



For Half Overlay Hinges		
For Use With	Item #	Box Qty
CLIP top 110°, CLIP top 120°, CLIP top 95° thick door, CLIP 100°	B973A0600	250



For Inset Hinges		
For Use With	Item #	Box Qty
CLIP top 110°, CLIP top 95° thick door, CLIP 100°	B973A0700	250

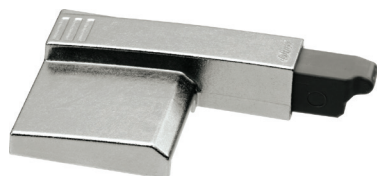

For 170° Hinges		
For Use With	Item #	Box Qty
CLIP top 170° - Full & Half Overlay	B973A6000	125

BLUMOTION SOFT-CLOSE DEVICES FOR BLUM EURO HINGES

A
B
C
D
E
F
G
H
I
J
K
L
M
N
O
P
Q
R
S
T
U
V
W
X
Y



BLUM 971A BLUMOTION for CLIP Hinges

- Soft-closing feature for CLIP top and CLIP full overlay hinges
- Offers the same quality of motion as drawer systems with BLUMOTION
- Adjustable to various door sizes and weights (+3/-7mm range)
- Installed onto hinge-side panel
- For use with full overlay hinge and either 0mm or 3mm mounting plate only
- Nickel-plated steel and gray nylon

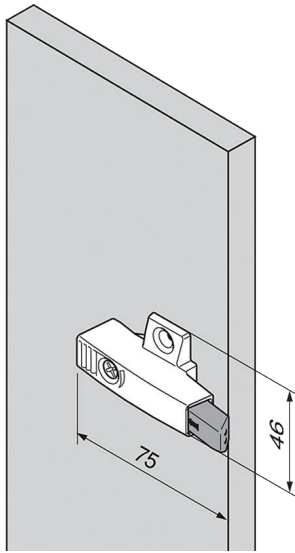

Wing Plate (Screw-on)

- 37mm setback, 32mm apart
- Attach with #6 x 5/8" wood screws
- Nickel-plated steel and gray nylon

Item #	Box Qty
B971A0500	25

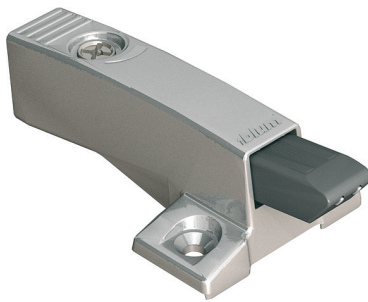

Face Frame Adapter Plate (Screw-On)

- 9.5mm setback, 32mm apart
- Attach with #6 x 5/8" wood screws
- Nickel-plated steel and gray nylon

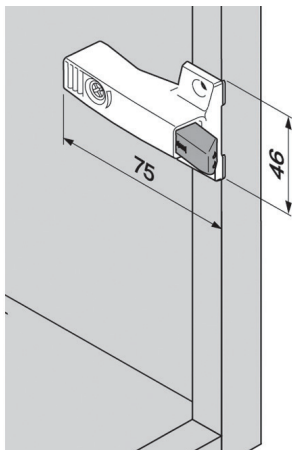

Item #	Box Qty
B971A0700	25

A BLUMOTION SOFT-CLOSE DEVICES FOR BLUM EURO HINGES

B
C
D
E
F
G
H
I
J
K
L
M
N
O
P
Q
R
S
T
U
V
W
X
Y



BLUM 970A BLUMOTION for CLIP Hinges



- Soft-closing feature for CLIP top and CLIP hinges
- Offers the same quality of motion as drawer systems with BLUMOTION
- Automatically adjusts to the closing force of the door
- Installed into the top and/or bottom panel or with adapter plates on hinge-side
- Gray nylon

Item #	Box Qty
B970A1002	50



Face Frame Adapter (Screw-On)

- 9.5mm setback, 32mm apart
- Can also be used in panel cabinets
- Attach with #6 x 5/8" wood screws
- Steel, nickel-plated

Item #	Box Qty
B970.5701	50

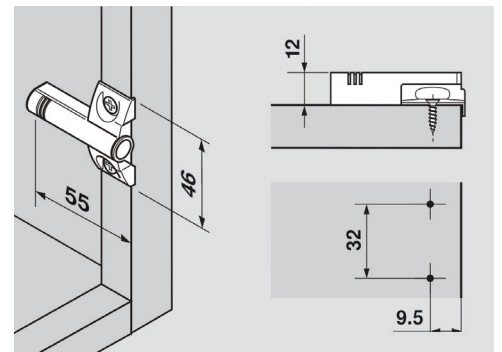

Wing Adapter (EXPANDO)

- 37mm setback, 32mm apart
- EXPANDO version installs with pre-attached screws
- Steel, nickel-plated

Item #	Box Qty
B970.55E1	50

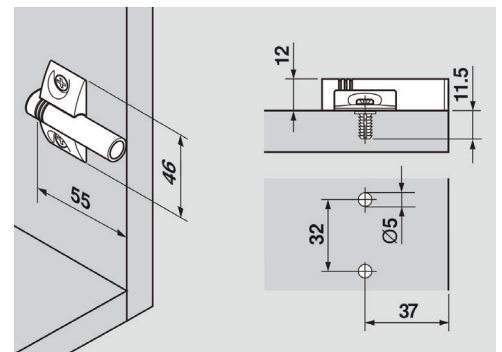

In-line Adapter (Screw-On)

- 20mm setback, 32mm apart
- Two-piece design
- Attach with #6 x 5/8" wood screws
- Steel, nickel-plated and gray nylon

Item #	Box Qty
B970.5201	50

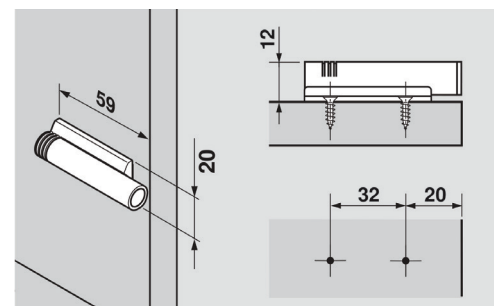

BLUM TIP-ON FOR DOORS



TIP-ON Set for Standard Door



- Nylon unit with magnetic tip
- Adjustment range +4mm to -1mm
- For use with Blum CLIP free swing hinges
- For door heights less than 48"
- Works for both overlay and inset applications
- Can be bored into the panel or used with an adapter plate
- Set includes: TIP-ON unit, self-adhesive catch plate, screw-on catch plate, and wood screw

Item #	Finish	Box Qty
B956.1004	Gray	50
B956.1004BL	Black	50
B956.1004WH	White	50



TIP-ON Set for Large Door



- Nylon unit with magnetic tip
- Adjustment range +4mm to -1mm
- For use with Blum CLIP free swing hinges
- For door heights greater than 48"
- Works for both overlay and inset applications
- Can be bored into the panel or used with an adapter plate
- Set includes: TIP-ON unit, self-adhesive catch plate, screw-on catch plate, and wood screw

Item #	Finish	Box Qty
B956A1004	Gray	50
B956A1004BL	Black	50
B956A1004WH	White	50



TIP-ON Unit for Self/Soft Close Hinges



- Nylon unit with bumper tip
- Adjustment range +4mm to -1mm
- For use with Blum self/soft close hinges
- For door widths greater than 10"
- Works for both overlay and inset applications
- Can be bored into the panel or used with an adapter plate

Item #	Finish	Box Qty
B956A1006	Gray	250
B956A1006BL	Black	250
B956A1006WH	White	250

A BLUM TIP-ON FOR DOORS

B
C
D
E
F
G
H
I
J
K
L
M
N
O
P
Q
R
S
T
U
V
W
X
Y



TIP-ON In-line Adapter Plate for Standard Door



- In-line adapter plate for standard door
- Two-piece, screw-on baseplate
- 20mm setback, 17mm apart
- Door gap factory setting 2mm
- Nylon

Item #	Finish	Box Qty
B956.1201	Gray	250
B956.1201BL	Black	50
B956.1201WH	White	250
B956.1201NK	Nickel	50



TIP-ON In-line Adapter Plate for Large Door



- In-line adapter plate for large door
- Two-piece, screw-on baseplate
- 20mm setback, 32mm apart
- Door gap factory setting 2mm
- Nylon

Item #	Finish	Box Qty
B956A1201	Gray	250
B956A1201BL	Black	50
B956A1201WH	White	250
B956A1201NK	Nickel	50



TIP-ON Wing Adapter Plate for Large Door



- Wing adapter plate for large door
- One-piece, screw-on wing plate
- 37mm setback, 32mm apart
- Door gap factory setting 2mm
- Gray nylon

Item #	Finish	Box Qty
B956A1501	Gray	250

BLUM COMPACT CLIP FACE FRAME HINGES W/SOFT-CLOSE

A
B
C
D
E
F
G
H
I
J
K
L
M
N
O
P
Q
R
S
T
U
V
W
X
Y



COMPACT CLIP 30C2, 7/16" Cup Depth



- 108° opening angle
- Utilizes CLIP technology, so doors can be attached and removed tool-free
- 3-dimensional cam adjustment w/directional arrows for precise adjustability
- Pre-mounted screw for time-saving and precise installation
- 3-dimensional cam adj: Height ±5/64" / Side-to-Side ±1/16" / Depth +3/32", -1/32"

Screw-On Item #	Dowel Item #	Overlay	Mount	Close	Finish	Box Qty
-	B30C258B.05	5/16"	Wraparound	Soft-Closing	Nickel	250
B30C255B.06	B30C258B.06	3/8"	Wraparound	Soft-Closing	Nickel	250
-	B30C258C.07	7/16"	Wraparound	Soft-Closing	Nickel	250
B30C255B.08	B30C258C.08	1/2"	Wraparound	Soft-Closing	Nickel	250
B30C255B.E8	B30C258C.E8	1/2"	Edge	Soft-Closing	Nickel	250
B30C255B.10	B30C258C.10	5/8"	Wraparound	Soft-Closing	Nickel	250
B30C255B.12	B30C258C.12	3/4"	Wraparound	Soft-Closing	Nickel	250

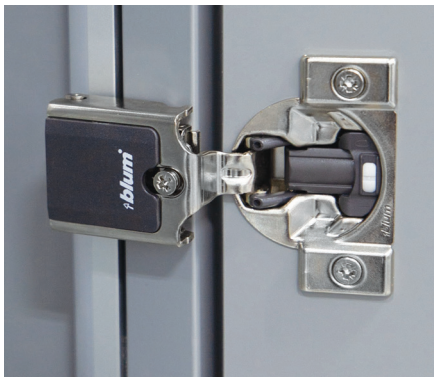

COMPACT CLIP 31C1, 7/16" Cup Depth



- 108° opening angle
- Utilizes CLIP technology, so doors can be attached and removed tool-free
- 3-dimensional cam adjustment w/directional arrows for precise adjustability
- Pre-mounted screw for time-saving and precise installation
- 3-dimensional cam adj: Height ±5/64" / Side-to-Side ±1/16" / Depth +3/32", -1/32"

Screw-On Item #	Dowel Item #	Overlay	Mount	Close	Finish	Box Qty
-	B31C158C.20	1-1/4"	Wraparound	Soft-Closing	Nickel	250



COMPACT CLIP 31C3, 1/2" Cup Depth



- 108° opening angle
- Utilizes CLIP technology, so doors can be attached and removed tool-free
- 3-dimensional cam adjustment w/directional arrows for precise adjustability
- Pre-mounted screw for time-saving and precise installation
- 3-dimensional cam adj: Height ±5/64" / Side-to-Side ±1/16" / Depth +3/32", -1/32"

Screw-On Item #	Dowel Item #	Overlay	Mount	Close	Finish	Box Qty
B31C355B.16	B31C358B.16	1"	Wraparound	Soft-Closing	Nickel	250
B31C355B.20	B31C358B.20	1-1/4"	Wraparound	Soft-Closing	Nickel	250
B31C355B.21	B31C358B.21	1-5/16"	Wraparound	Soft-Closing	Nickel	250
B31C355B.22	B31C358B.22	1-3/8"	Wraparound	Soft-Closing	Nickel	250
B31C355B.24	B31C358B.24	1-1/2"	Wraparound	Soft-Closing	Nickel	250
-	B31C358B.25	1-9/16"	Wraparound	Soft-Closing	Nickel	250

A BLUM COMPACT CLIP HINGE ACCESSORIES

B
C
D
E
F
G
H
I
J
K
L
M
N
O
P
Q
R
S
T
U
V
W
X
Y

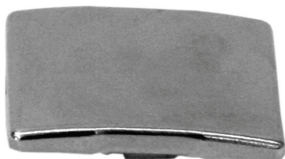

Hinge Arm Cover Caps

- Steel, nickel-plated caps
- Available blank or embossed (Blum logo)
- Also available with printed custom logo (Special order - minimum order quantity applies)



Blum Logo Item #	Blank Item #	Designed For	Box Qty
B30C2508.BL	B30C2508	Large Overlay 30C2 / 31C1 / 31C3 Compact CLIP Hinges	1,000
B31C1508.BL	B31C1508	Small Overlay 30C2 / 31C1 / 31C3 Compact CLIP Hinges	1,000



Angle Restriction Clip

- Restricts opening angle of the COMPACT CLIP hinge to 86°
- Clip must be inserted before the hinge has been attached to the face frame
- Gray nylon



Item #	Box Qty
B38C315B3	250

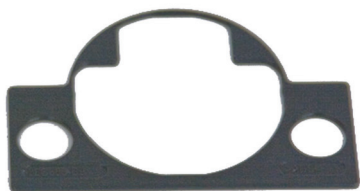

Hinge Cup Spacer

- 1/16" spacer for use under the hinge cup for thin or profile doors
- Non-stackable
- Gray nylon



Item #	Box Qty
B38C355B9	250

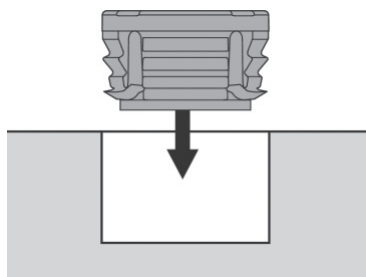

8mm Dowels

- 8mm Dowels for Blum's COMPACT CLIP hinges: 30C2, 31C1 and 31C3



Item #	Box Qty
B30C258	1,000

BLUM COMPACT SOFT-CLOSE FACE FRAME HINGES



COMPACT BLUMOTION 38N Hinges for Partial Overlay



- BLUMOTION integrated into the hinge cup
- Deactivation switch for small/light doors
- Overload safety feature
- 7/16" cup depth
- Edge mount available in 1/2" overlay

Item #	Opening	Overlay	Fixing	Mount	Box Qty
B38N358B.05	105°	5/16"	Dowel	Wraparound	250
B38N355B.06	105°	3/8"	Screw-On	Wraparound	250
B38N358B.06	105°	3/8"	Dowel	Wraparound	250
B38N355B.08	105°	1/2"	Screw-On	Wraparound	250
B38N358B.08	105°	1/2"	Dowel	Wraparound	250
B38N355BE08	105°	1/2"	Screw-On	Edge	250
B38N358BE08	105°	1/2"	Dowel	Edge	250
B38N355B.10	105°	5/8"	Screw-On	Wraparound	250
B38N358B.10	105°	5/8"	Dowel	Wraparound	250
B38N355B.12	105°	3/4"	Screw-On	Wraparound	250
B38N358B.12	105°	3/4"	Dowel	Wraparound	250



COMPACT BLUMOTION 39C Hinges for Full Overlay



- BLUMOTION integrated into the hinge cup
- Deactivation switch for small/light doors
- Overload safety feature
- One-piece wraparound hinge
- 1/2" cup depth
- Less minimum reveal

Item #	Opening	Overlay	Fixing	Mount	Box Qty
B39C355B.16	110°	1"	Screw-On	Wraparound	300
B39C358B.16	110°	1"	Dowel	Wraparound	300
B39C355B.20	110°	1-1/4"	Screw-On	Wraparound	300
B39C358B.20	110°	1-1/4"	Dowel	Wraparound	300
B39C355B.21	110°	1-5/16"	Screw-On	Wraparound	300
B39C358B.21	110°	1-5/16"	Dowel	Wraparound	300
B39C355B.22	110°	1-3/8"	Screw-On	Wraparound	300
B39C358B.22	110°	1-3/8"	Dowel	Wraparound	300
B39C355B.24	110°	1-1/2"	Screw-On	Wraparound	300
B39C358B.24	110°	1-1/2"	Dowel	Wraparound	300
B39C355B.25	110°	1-9/16"	Screw-On	Wraparound	300
B39C358B.25	110°	1-9/16"	Dowel	Wraparound	300

A
B
C
D
E
F
G
H
I
J
K
L
M
N
O
P
Q
R
S
T
U
V
W
X
Y

A BLUM COMPACT SOFT-CLOSE FACE FRAME HINGES

B
C
D
E
F
G
H
I
J
K
L
M
N
O
P
Q
R
S
T
U
V
W
X
Y

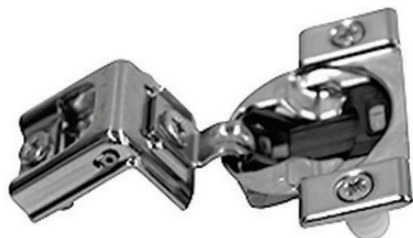

COMPACT BLUMOTION 38C Hinges for Full Overlay



- BLUMOTION integrated into the hinge cup
- Deactivation switch for small/light doors
- Overload safety feature
- One-piece wraparound hinge
- 7/16" cup depth
- Ideal for profiled doors

Item #	Opening	Overlay	Fixing	Mount	Box Qty
B38C355B.20	107°	1-1/4"	Screw-On	Wraparound	300
B38C358B.20	107°	1-1/4"	Dowel	Wraparound	300



COMPACT BLUMOTION 38B Hinges for Face Mount



- BLUMOTION integrated into the hinge cup
- Deactivation switch for small/light doors
- Overload safety feature
- One-piece face mount hinge
- 7/16" cup depth
- Ideal for large overlays or refacing of cabinets

Item #	Opening	Overlay	Fixing	Mount	Box Qty
B38B355BF22	107°	1-3/8" or greater	Screw-On	Face Mount	250
B38B358BF22	107°	1-3/8" or greater	Dowel	Face Mount	250

BLUM COMPACT SOFT-CLOSE HINGE ACCESSORIES

A
B
C
D
E
F
G
H
I
J
K
L
M
N
O
P
Q
R
S
T
U
V
W
X
Y

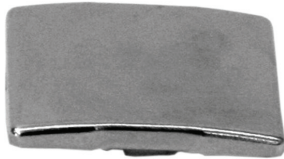

Hinge Arm Cover Caps



- Steel, nickel-plated caps
- Available blank or embossed (Blum logo)
- Also available with printed custom logo (Special order - minimum order quantity applies)

Item #	Description	Box Qty
B38C3508	39C/38C Blank Cover Cap	1,000
B38N3508B	38N Blank Cover Cap	1,000



Angle Restriction Clip



- Restricts opening angle of the COMPACT BLUMOTION hinge to 86°
- Clip must be inserted before the hinge has been attached to the face frame
- Gray nylon

Item #	Box Qty
B38C315B3	250

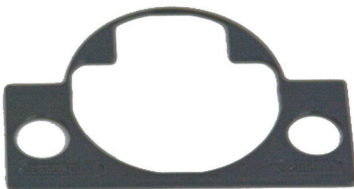

Hinge Cup Spacer



- 1/16" spacer for use under the hinge cup for thin or profile doors
- Non-stackable
- Gray nylon

Item #	Box Qty
B38C355B9	250

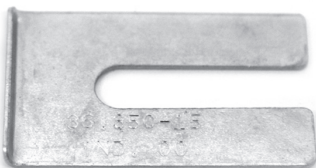

Distance Spacer



- Steel spacer decreases door overlay in 1/32" increments
- Can be stacked to achieve desired overlay reduction
- Steel, zinc-coated

Item #	Box Qty
B36.3515	1,000

A BLUM COMPACT SELF-CLOSE FACE FRAME HINGES

B
C
D
E
F
G
H
I
J
K
L
M
N
O
P
Q
R
S
T
U
V
W
X
Y

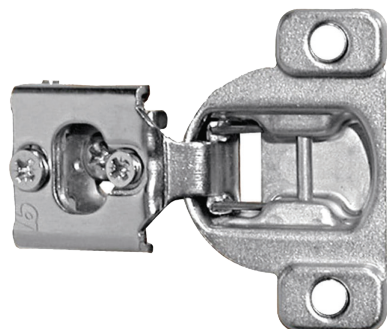

COMPACT 38N Hinges for Partial Overlay



- 105° opening angle
- One piece assembly
- Wraparound or edge mount
- 7/16" cup depth
- ±1/8" height adjustment
- ±1/16" side adjustment
- +3/32", -1/32" cam depth adjustment
- Steel, nickel-plated
- Can be used with BLUMOTION 971A9700

Item #	Opening	Overlay	Fixing	Mount	Box Qty
B38N355.06	105°	3/8"	Screw-On	Wraparound	250
B38N358.06	105°	3/8"	Dowel	Wraparound	250
B38N355.08	105°	1/2"	Screw-On	Wraparound	250
B38N358.08	105°	1/2"	Dowel	Wraparound	250
B38N358CE.08	105°	1/2"	Dowel	Edge	250
B38N355CE08	105°	1/2"	Screw-On	Edge	250
B38N355.10	105°	5/8"	Screw-On	Wraparound	250
B38N358.10	105°	5/8"	Dowel	Wraparound	250
B38N355C.12	105°	3/4"	Screw-On	Wraparound	250
B38N358.12	105°	3/4"	Dowel	Wraparound	250



COMPACT 39C Hinges for Full Overlay



- 110° opening angle
- One piece assembly
- Wraparound mount
- 1/2" cup depth
- ±1/8" height adjustment
- ±1/16" side adjustment
- +3/32", -1/32" cam depth adjustment
- Steel, nickel-plated
- Can be used with BLUMOTION 971A9700

Item #	Opening	Overlay	Fixing	Mount	Box Qty
B39C358C.16	110°	1"	Dowel	Wraparound	300
B39C358C.20	110°	1-1/4"	Dowel	Wraparound	300
B39C358C.22	110°	1-3/8"	Dowel	Wraparound	300
B39C358C.24	110°	1-1/2"	Dowel	Wraparound	300

BLUM COMPACT SELF-CLOSE FACE FRAME HINGES

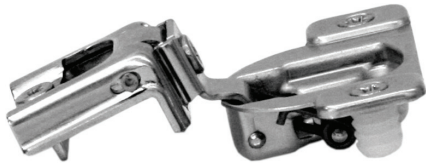

COMPACT 38C Hinges for Full Overlay



- 107° opening angle
- One piece assembly
- Wraparound mount
- 7/16" cup depth
- ±1/8" height adjustment
- ±1/16" side adjustment
- +3/32", -1/32" cam depth adjustment
- Steel, nickel-plated
- Can be used with BLUMOTION 971A9700

Item #	Opening	Overlay	Fixing	Mount	Box Qty
B38C355.20	107°	1-1/4"	Screw-On	Wraparound	300
B38C358.20	107°	1-1/4"	Dowel	Wraparound	300
B38C358.22	107°	1-3/8"	Dowel	Wraparound	300
B38C358C.24	107°	1-1/2"	Dowel	Wraparound	300
B38C358C.25	107°	1-9/16"	Dowel	Wraparound	300

Visit us on our website: wurthlac.com

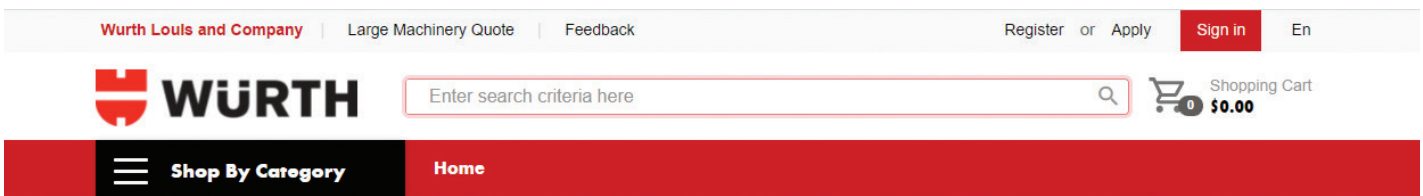

Würth Louis and Company

Introduces:

RGB TUNABLE FLEXTAPE®

Creating dramatic lighting with 16 million color combinations is now a reality with RGB Standard color-changing FlexTape®.

1 2 3 4 5



A
B
C
D
E
F
G
H
I
J
K
L
M
N
O
P
Q
R
S
T
U
V
W
X
Y

A BLUM COMPACT SELF-CLOSE FACE FRAME HINGE ACCESSORIES

B
C
D
E
F
G
H
I
J
K
L
M
N
O
P
Q
R
S
T
U
V
W
X
Y



Blum 971A for Blum COMPACT Hinges



- Can be used for all Blum COMPACT Hinges

Item #	Application	Box Qty
B971A9700.A1 Polybag Set*	Full or partial overlay	125

* Set Includes: BLUMOTION mechanism, spacer, #8 x 1-1/4" type 17 wood screw, and #8 x 2" type 17 wood screw



COMPACT 38N Cover Cap



- Use with COMPACT 38N hinges
- Clip on attachment/removal
- Available blank or with printed custom logo (Special order - minimums apply)
- Steel, nickel-plated

Item #	Description	Box Qty
B38N3508B	Blank Cover Cap	1,000

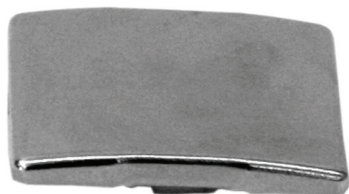

COMPACT 39C/38C Cover Cap



- Use with COMPACT 39C/38C hinges only
- Clip on attachment/removal
- Available blank/embossed blum logo or with printed custom logo (Special order - minimums apply)
- Steel, nickel-plated

Item #	Description	Box Qty
B38C3508	Blank Cover Cap	1,000



Distance Spacer



- Steel spacer decreases door overlay in 1/32" increments
- Can be stacked to achieve desired overlay reduction
- Steel, zinc-coated

Item #	Box Qty
B36.3515	1,000

BLUM HINGE MACHINES



MINIPRESS P - Deluxe Boring and Insertion Machine



- Front adjustable boring distance with digital counter
- Pneumatic hold-down clamps
- Boring depth adjustment
- Ruler stops (qty 4)
- Tool kit included
- Dust collection attachment
- Optional laser center line set
- Accepts new 8 or 9 spindle heads

Item #	Description
BM53.1053US	Single Phase - 220V Power
BM53.1004US	Three Phase - 220V Power



MINIPRESS M - 110V Manual Boring and Insertion Machine



- 110V power with molding plug (portable)
- Does not require pressurized air
- Ruler stops (qty 4)
- Tool kit included
- Dust collection attachment
- Accepts new 8 or 9 spindle heads

Item #	Description
BM52.1056US	Single Phase - 110V Power



MINIDRILL P - Standard Boring Machine



- Front adjustable boring distance
- Ruler stops (qty 4)
- Tool kit included
- Dust collection attachment
- Optional laser center line, digital counter and hold down clamps sets
- Accepts new 8 or 9 spindle heads

Item #	Description
BM53.1053.50	Single Phase - 220V Power

A
B
C
D
E
F
G
H
I
J
K
L
M
N
O
P
Q
R
S
T
U
V
W
X
Y

A **BLUM HINGE MACHINES**

B

C

D

E

F

G

H

I

J

K

L

M

N

O

P

Q

R

S

T

U

V

W

X

Y



9-Spindle Head

- 9 spindle head for use with MINIPRESS/MINIDRILL
- Bores nine holes spaced 32 mm apart, parallel to the fence
- Quick-disconnect chucks
- Once aligned, does not require additional adjustment
- Bores cabinet side panel for 32 mm system boring for Blum mounting plates and runners
- Requires retrofit set for use with machines produced in 2009 or prior
- **Includes:** 3mm allen wrench, distance spacer, drive pin, and air hose

NOTE: Requires 5 each of left hand and 4 each right hand drill bits. Recommended drill bit size for quick disconnect chucks: overall length is 57mm and shank is 10mm in diameter and 27mm in length.



Item #	Description
BMZK.190S	9-Spindle Head



8-Spindle Head

- 8 spindle head for use with MINIPRESS/MINIDRILL
- Bores eight holes spaced 32 mm apart, perpendicular to the fence
- Quick-disconnect chucks
- Once aligned, does not require additional adjustment
- Bores all Box Systems front fixing brackets/galleries
- Bores cabinet side panels for all Blum runner systems
- Requires retrofit set for use with machines produced in 2009 or prior
- **Includes:** 3mm allen wrench, distance spacer, drive pin, and air hose

NOTE: Requires 4 each of left hand and 4 each right hand drill bits. Recommended drill bit size for quick disconnect chucks: overall length is 57mm and shank is 10mm in diameter and 27mm in length.



Item #	Description
BMZK.880S	8-Spindle Head



Spindle Head Retrofit Set

- Required for 9 and 8 spindle heads to MINIPRESS/MINIDRILL produced in 2009 and prior
- Previous boring heads MZK.1000.US and MZK.8000.US cannot be used with the retrofit set
- **Set Includes:**
 - Adapter ring and shield
 - 5mm allen wrench
 - Mounting bolts (qty 4)
 - Alignment pins (qty 2)
 - Alignment template
 - 13mm fixed depth stop (qty 2)



Item #	Description
BM30.1313.UM	Spindle Head Retrofit Set

BLUM HINGE MACHINE ACCESSORIES

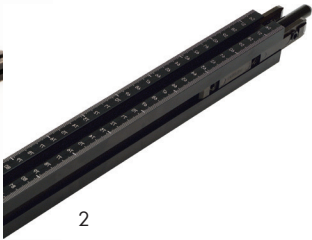

	Item #	Description
1	B06635734	Center Ruler, 2' (600mm)
2	BMZL.1250.US	Extension Ruler, 4' (1250mm)
3	BMZS.2000L	Small Ruler Stop, left
4	BMZS.2000R	Small Ruler Stop, right
5	B06960651	Breakaway Clutch - For MINIPRESS and MINIDRILL



#10 Euro Hinge Insertion Ram

- Can be used for inserting CLIP top BLUMOTION, CLIP top and CLIP dowed hinges
- Not for use with wide angled or specialty hinges

NOTE: Can be used with CLIP top BLUMOTION 95°, CLIP top 95°, and CLIP 100° by adjusting the ball plungers.

Item #
BMZM.0010.01

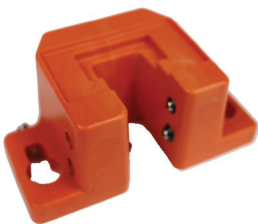

#18 Euro Hinge Insertion Ram

- Can be used for inserting Blum wide angle dowed hinges

Item #
BMZM.0018.01

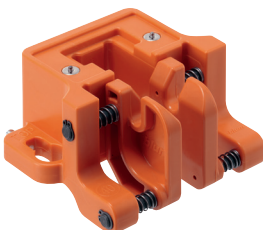

#40 Euro Hinge Insertion Ram

- Can be used for inserting most Blum dowed hinges

NOTE: Not for use with 170°, 155°, and 125° wide angle hinges.

Item #
BMZM.0040

A
B
C
D
E
F
G
H
I
J
K
L
M
N
O
P
Q
R
S
T
U
V
W
X
Y

A BLUM HINGE MACHINE ACCESSORIES

B
C
D
E
F
G
H
I
J
K
L
M
N
O
P
Q
R
S
T
U
V
W
X
Y



#47 COMPACT Hinge Insertion Ram

- Can be used for inserting all Blum COMPACT dowelled hinges



Item #
BMZM.0047

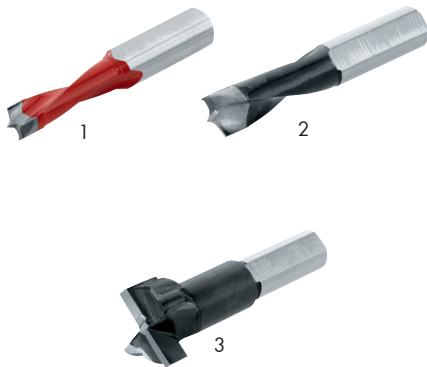

Machine Drill Bits



	Item #	Description
1	BM01ZB08.03L	8mm Drill Bit (Left Handed)
2	BM01ZB10.02	10mm Drill Bit (Right Handed)
	BM01ZB10.03	10mm Drill Bit (Left Handed)
3	BM01.ZB35.02R	35mm Drill Bit (Right Handed)



Twist Drill Bits - High Speed Steel



	Item #	Description
1	BPVPB-5	VPB-5 Centering Bit
2	BDB-1/8LH	2mm Left Twist Bit
	BDB-2.5MM	2.5mm Right Twist Bit
	BDB-5MM	5mm Right Twist Bit
	BDB-6MM	6mm Right Twist Bit
	BDB-10MM	10mm Right Twist Bit
3	BDB-10X2MM	10mm Chuck for BDB-1/8LH

BLUM HINGE ASSEMBLY AIDS



Knock-in Tool

- Can be used to insert all Blum dowelled hinges



Item #
BZME.0710



ECODRILL

- Simple device for boring Blum hinge pattern
- Driven by electric or cordless drill (18v or higher)
- Boring distance adjusts from 2mm to 8mm
- Clamps to various door thicknesses up to 40mm
- Includes drill bits (pre-installed) and two Torx bits



Item #	Description
BM31.1000	ECODRILL
BM31.ZB35.02	Replacement 35mm bit
BM31.ZB08.02	Replacement 8mm bit
BMZW.1300	Tool Set

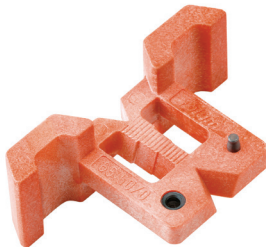

ECOJIG

- Used to bore 5mm holes for mounting plates that are mounted with system screws, EXPANDO dowels or INSERTA
- Also can be used to pre-bore 5mm holes for EXPANDO BLUMOTION adapters
- 5mm stop collar included



Item #
B65.5070

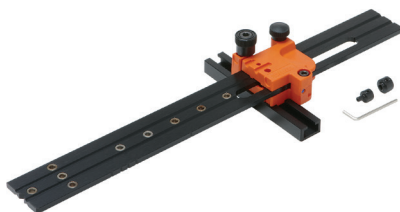

Universal Individual Template

- For pre-boring mounting plates
- Also used for marking and pre-boring cabinet profiles, BLUMOTION, TIP-ON adapter plates and AVENTOS locating pins
- Calibrated scale for accurate setting



Item #
B65.1051.02

A BLUM HINGE ASSEMBLY AIDS

B
C
D
E
F
G
H
I
J
K
L
M
N
O
P
Q
R
S
T
U
V
W
X
Y



Mounting Plate Template

- For pre-boring TIP-ON for doors wing and in-line adapters
- Can also be used to bore for wing (37mm) and in-line (20mm) mounting plates
- Additional hole location added (37mm) for in-line adapter for standard doors
- Simple location of adapter and mounting plate screw positions
- Pilot bore 2.5mm holes for wood screws



Item #
B65.5300

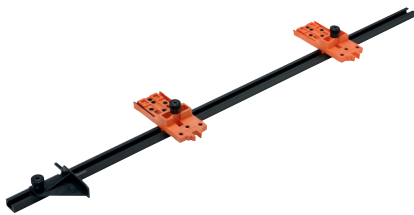

QUICKFIX

- Drilling sleeve dimensions changed from 2.5mm to 5mm for drilling for in-line mounting plates
- Locates/matches positions of hinges and plates on cabinets and doors
- Transfers positions from door-to-cabinet and cabinet-to-door
- Adjustable stop for various door overlays
- For use with wing or in-line mounting plates



Item #	Description
B65.7500	QUICKFIX
B65.7510.03	Additional CLIP Template
B65.7590	7' (2200mm) Rail
BDB-5MM	5mm Drill Bit



PLATEMATE

- Boring template for all Blum face frame adapter plates
- Clamps to the frame with cam lever
- Adjustment knob accomodates frame thicknesses of 5/8" to 1"
- Spacer screws permit quick use without measuring
- Includes 2.5mm pilot bit and drill bit extension



Item #
B65.5030.01

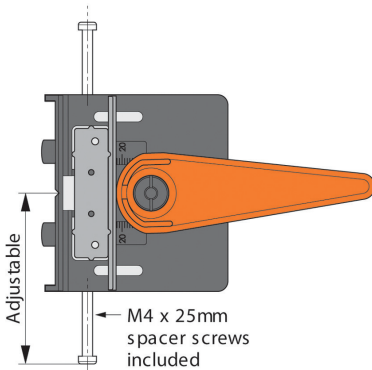

BLUM HINGE ASSEMBLY AIDS

A
B
C
D
E
F
G
H
I
J
K
L
M
N
O
P
Q
R
S
T
U
V
W
X
Y



INSERTA Boring Template

- For boring 8mm dowel holes after 35mm hole is bored
- Boring distance adjusts from 2mm to 8mm
- Also bores 5mm holes for system screw mounting plates
- Includes stop collar to pilot bore 2.5mm for screw-on plates



Item #
B65.059A



BLUMOTION and TIP-ON for Doors Boring Template

- For pre-boring BLUMOTION and TIP-ON units
- 10mm drill bushing for edge boring
- Bores left and right side of cabinet
- Includes 10mm stop collar

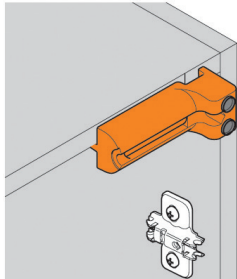

Item #
B65.5010



Deep Thread Wood Screws

- For attaching hinges and mounting plates



Item #	Description	Box Qty
B606P-1000	#6 x 5/8", #2 POZI	1,000



Deep Thread System/Euro Screws

- Pilot bore 3/16" (5mm) hole



Item #	Description	Box Qty
B661.1000.HG	#7 x 10mm, #2 POZI	1,000
B661.1150.HG	#7 x 11.5mm, #2 POZI	1,000
B661.1300.HG	#7 x 13mm, #2 POZI	1,000
BSS-14.5MM	#7 x 14.5mm, #2 POZI	1,000

A BLUM HINGE ASSEMBLY AIDS

B
C
D
E
F
G
H
I
J
K
L
M
N
O
P
Q
R
S
T
U
V
W
X
Y



Pan Head System/Euro Screw

- Pilot bore 3/16" (5mm) hole



Item #	Description	Box Qty
B668.145	#7 x 14.5mm, #2 POZI	1,000



Truss Head Screw

- For attaching COMPACT hinges to the face frame
- Type 17



Item #	Description	Box Qty
B834TH	#8 x 3/4", #2 Phillips	100



Twin Application Screws

- Pre-bored 3/16" (5mm) hole



	Item #	Description	Box Qty
1	B612.2010	9/16" (14mm) Screw	250
2	B612.2020	5/8" (16mm) Sleeve for Panel Thickness 16-20mm	250
	B612.2420	25/32" (20mm) Sleeve for Panel Thickness 20-24mm	250

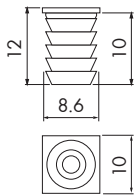

8mm Square Head Dowel

- For attaching to hinges



Item #	Description	Box Qty
B34.3582.01	8.6mm x 12mm Square Dowel	1,000

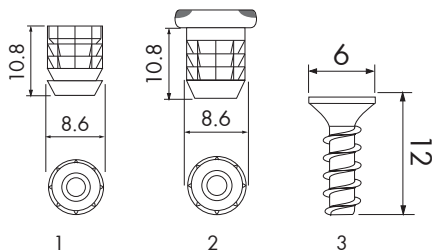

8mm Round Dowel

- For insertion into doors



	Item #	Description	Box Qty
1	B70.0532	8.6mm x 10.8mm Round Dowel	1,000
2	B70T5582.01	8.6mm x 10.8mm Square Dowel	1,000
3	B608.1200	6mm x 12mm Installation Screw	1,000



POZI DRIVER and Bits



	Item #	Description	Box Qty
1	BPD	#2 POZI DRIVER	20
2	BMAGHLDR	1/4" Magnetic Bit Holder	1
3	B2X1POZIBIT	#2 x 1" POZI Bit Insert	1

GRASS TIOMOS SOFT-CLOSE EURO HINGES



110° Tiomos Soft-Closing Hinges



- Adjustable soft-close mechanism integrated and concealed in hinge arm
- Uniform closing action regardless of door size, weight, or materials
- Soft-close mechanism can be adjusted easily without tools, even after doors are installed
- Each soft-close hinge has 3 settings for closing performance

Item #	Quick Code	Boring Pattern	Fixing	Close Type	Box Qty
Full Overlay Hinges (Cranking 00) - Up to 7/8" (22mm) Overlay					
GTIOF028138341228	GT258	42mm	Dowelled	Soft-close	150
GTIOF028138519228	GT100	45mm	Screw-On	Soft-close	150
GTIOF028138523228	GT101	45mm	Dowelled	Soft-close	150
GTIOF017139414228	GT233	42/45mm	Impresso (Tool Free)	Soft-close	150
Overlay Hinges (Cranking 03) - Up to 3/4" (19mm) Overlay					
GTIOF028138342228	GT259	42mm	Dowelled	Soft-close	150
GTIOF028138520228	GT104	45mm	Screw-On	Soft-close	150
GTIOF028138524228	GT105	45mm	Dowelled	Soft-close	150
GTIOF017139415228	GT234	42/45mm	Impresso (Tool Free)	Soft-close	150
Half Overlay Hinges (Cranking 9.5)					
GTIOF028138343228	GT260	42mm	Dowelled	Soft-close	150
GTIOF028138521228	GT108	45mm	Screw-On	Soft-close	150
GTIOF028138525228	GT109	45mm	Dowelled	Soft-close	150
GTIOF017139416228	GT235	42/45mm	Impresso (Tool Free)	Soft-close	150
Inset Hinges (Cranking 19)					
GTIOF028138344228	GT261	42mm	Dowelled	Soft-close	50
GTIOF028138522228	GT112	45mm	Screw-On	Soft-close	150
GTIOF028138526228	GT113	45mm	Dowelled	Soft-close	150
GTIOF017139417228	GT236	42/45mm	Impresso (Tool Free)	Soft-close	150



Angle Restriction Clip			
Item #	Quick Code	Description	Box Qty
GTIOF072135751517	GT224	Reduces opening angle to 85°	50



Accessory Items	
Item #	Description
AN203351	35mm Hinge Boring Bit
AN301008	8mm LH Bit, 57mm L

A
B
C
D
E
F
G
H
I
J
K
L
M
N
O
P
Q
R
S
T
U
V
W
X
Y

A GRASS TIOMOS SOFT-CLOSE EURO HINGES

B
C
D
E
F
G
H
I
J
K
L
M
N
O
P
Q
R
S
T
U
V
W
X
Y



120° Tiomos Soft-Closing Hinges



- Adjustable soft-close mechanism integrated and concealed in hinge arm
- Uniform closing action regardless of door size, weight, or materials
- Soft-close mechanism can be adjusted easily without tools, even after doors are installed
- Each soft-close hinge has 3 settings for closing performance

Item #	Quick Code	Boring Pattern	Fixing	Close Type	Box Qty
Full Overlay Hinges (Cranking 00) - Up to 7/8" (22mm) Overlay					
GTIOF028138369228	GT262	42mm	Dowelled	Soft-close	150
GTIOF028138547228	GT116	45mm	Screw-On	Soft-close	150
GTIOF028138551228	GT117	45mm	Dowelled	Soft-close	150
GTIOF017139428228	GT245	42/45mm	Impresso (Tool Free)	Soft-close	150
Overlay Hinges (Cranking 03) - Up to 3/4" (19mm) Overlay					
GTIOF028138370228	GT263	42mm	Dowelled	Soft-close	150
GTIOF028138548228	GT120	45mm	Screw-On	Soft-close	150
GTIOF028138552228	GT121	45mm	Dowelled	Soft-close	150
GTIOF017139429228	GT246	42/45mm	Impresso (Tool Free)	Soft-close	150
Half Overlay Hinges (Cranking 9.5)					
GTIOF028138371228	GT264	42mm	Dowelled	Soft-close	150
GTIOF028138549228	GT124	45mm	Screw-On	Soft-close	150
GTIOF028138553228	GT125	45mm	Dowelled	Soft-close	150
GTIOF017139430228	GT247	42/45mm	Impresso (Tool Free)	Soft-close	150



Angle Restriction Clip			
Item #	Quick Code	Description	Box Qty
GTIOF072135751517	GT224	Reduces opening angle to 85°	50



Accessory Items	
Item #	Description
AN203351	35mm Hinge Boring Bit
AN301008	8mm LH Bit, 57mm L

GRASS TIOMOS SOFT-CLOSE EURO HINGES



155° Tiomos Soft-Closing Hinges



- Adjustable soft-close mechanism integrated and concealed in hinge arm
- Uniform closing action regardless of door size, weight, or materials
- Soft-close mechanism can be adjusted easily without tools, even after doors are installed
- Each soft-close hinge has 3 settings for closing performance

Item #	Quick Code	Boring Pattern	Fixing	Close Type	Box Qty
Full Overlay Hinges (Cranking 00) - Up to 7/8" (22mm) Overlay					
GTIOF028138382217	GT265	42mm	Dowelled	Soft-close	50
GTIOF028138561217	GT128	45mm	Screw-On	Soft-close	50
GTIOF028138564217	GT129	45mm	Dowelled	Soft-close	50
GTIOF017139435217	GT251	42/45mm	Impresso (Tool Free)	Soft-close	50
Overlay Hinges (Cranking 03) - Up to 3/4" (19mm) Overlay					
GTIOF028138383217	GT266	42mm	Dowelled	Soft-close	50
GTIOF028138562217	GT132	45mm	Screw-On	Soft-close	50
GTIOF028138565217	GT133	45mm	Dowelled	Soft-close	50
GTIOF017139436217	GT252	42/45mm	Impresso (Tool Free)	Soft-close	50
Half Overlay Hinges (Cranking 9.5)					
GTIOF028138563217	GT136	45mm	Screw-On	Soft-close	50
GTIOF028138566217	GT137	45mm	Dowelled	Soft-close	50

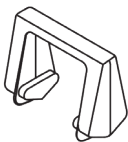

Angle Restriction Clip		
Item #	Description	Box Qty
GTIOF072135753517	Reduces opening angle to 120°	50



Accessory Items	
Item #	Description
AN203351	35mm Hinge Boring Bit
AN301008	8mm LH Bit, 57mm L

A GRASS TIOMOS SOFT-CLOSE EURO HINGES

B
C
D
E
F
G
H
I
J
K
L
M
N
O
P
Q
R
S
T
U
V
W
X
Y



Tiomos 95° Hinges for Thick Doors



- 3-dimensional adjustment with suitable baseplate
- Accommodates overlays up to 24mm (15/16")
- For door thicknesses up to 36 mm (1-7/16")
- For face frame or frameless cabinets
- Convenient depth adjustment with worm gear

Item #	Quick Code	Boring Pattern	Fixing Type	Closing Type	Box Qty
Full Overlay Hinges (Cranking 00) - Up to 7/8" (22mm) Overlay					
GTIOF028138389228	GT268	42mm	Dowelled	Soft-close	150
GTIOF028138567228	GT272	45mm	Screw-On	Soft-close	150
GTIOF028138571228	GT276	45mm	Dowelled	Soft-close	150
GTIOF017139438228	GT254	42/45mm	Impresso (Tool Free)	Soft-close	50
Overlay Hinges (Cranking 03) - Up to 3/4" (19mm) Overlay					
GTIOF028138568228	GT273	45mm	Screw-On	Soft-close	150
GTIOF028138572228	GT277	45mm	Dowelled	Soft-close	150
GTIOF017139439228	GT255	42/45mm	Impresso (Tool Free)	Soft-close	50
Half Overlay Hinges (Cranking 9.5)					
GTIOF028138391228	GT270	42mm	Dowelled	Soft-close	150
GTIOF028138569228	GT274	45mm	Screw-On	Soft-close	150
GTIOF028138573228	GT278	45mm	Dowelled	Soft-close	150
GTIOF017139440228	GT256	42/45mm	Impresso (Tool Free)	Soft-close	150
Inset Hinges (Cranking 19)					
GTIOF028138570228	GT275	45mm	Screw-On	Soft-close	150
GTIOF028138574228	GT279	45mm	Dowelled	Soft-close	150
GTIOF017139441228	GT257	42/45mm	Impresso (Tool Free)	Soft-close	50



Cover Caps			
Item #	Quick Code	Finish	Box Qty
GTIOF072135500247	GT221	Steel, Nickel-Plated	1,000

Hinge Cup Cover Cap			
Item #	Quick Code	Finish	Box Qty
GTIOF072135503228	GT223	Steel, Nickel-Plated	150

#6 x 5/8" FHP Screw		
Item #	Finish	Box Qty
G81001-43	Steel, Nickel-Plated	500

GRASS TIOMOS EURO HINGES



110° Tiomos Self-Closing & Free Swinging Hinges



- 3-dimensional adjustment with suitable baseplate
- For face frame or frameless cabinets
- Convenient depth adjustment with worm gear

Item #	Quick Code	Boring Pattern	Fixing	Close Type	Box Qty
Full Overlay Hinges (Cranking 00) - Up to 7/8" (22mm) Overlay					
GTIOF045138279228	GT305	42mm	Dowelled	Self-close	150
GTIOF045138457228	GT102	45mm	Screw-on	Self-close	150
GTIOF045138461228	GT103	45mm	Dowelled	Self-close	150
GTIOF034139385228	GT280	42/45mm	Impresso (Tool Free)	Self-close	150
Overlay Hinges (Cranking 03) - Up to 3/4" (19mm) Overlay					
GTIOF045138280228	GT306	42mm	Dowelled	Self-close	150
GTIOF045138458228	GT106	45mm	Screw-On	Self-close	150
GTIOF045138462228	GT107	45mm	Dowelled	Self-close	150
GTIOF034139386228	GT281	42/45mm	Impresso (Tool Free)	Self-close	150
GTIOF035139443228	GT332	42/45mm	Impresso (Tool Free)	Free Swing	150
Half Overlay Hinges (Cranking 9.5)					
GTIOF045138281228	GT307	42mm	Dowelled	Self-close	150
GTIOF045138459228	GT110	45mm	Screw-On	Self-close	150
GTIOF045138463228	GT111	45mm	Dowelled	Self-close	150
GTIOF034139387228	GT282	42/45mm	Impresso (Tool Free)	Self-close	150
GTIOF035139444228	GT333	42/45mm	Impresso (Tool Free)	Free Swing	150
Inset Hinges (Cranking 19)					
GTIOF045138282228	GT308	42mm	Dowelled	Self-close	150
GTIOF045138460228	GT114	45mm	Screw-On	Self-close	150
GTIOF045138464228	GT115	45mm	Dowelled	Self-close	150
GTIOF034139388228	GT283	42/45mm	Impresso (Tool Free)	Self-close	50



Angle Restriction Clip			
Item #	Quick Code	Description	Box Qty
GTIOF072135751517	GT224	Reduces opening angle to 85°	50

Accessory Items	
Item #	Description
AN203351	35mm Hinge Boring Bit
AN301008	8mm LH Bit, 57mm L

A
B
C
D
E
F
G
H
I
J
K
L
M
N
O
P
Q
R
S
T
U
V
W
X
Y

A GRASS TIOMOS EURO HINGES

B
C
D
E
F
G
H
I
J
K
L
M
N
O
P
Q
R
S
T
U
V
W
X
Y



120° Tiomos Self-Closing Hinges

- 3-dimensional adjustment with suitable baseplate
- For face frame or frameless cabinets
- Convenient depth adjustment with worm gear



Item #	Quick Code	Boring Pattern	Fixing	Close Type	Box Qty
Full Overlay Hinges (Cranking 00) - Up to 7/8" (22mm) Overlay					
GTIOF045138307228	GT309	42mm	Dowelled	Self-close	150
GTIOF045138485228	GT118	45mm	Screw-On	Self-close	150
GTIOF045138489228	GT119	45mm	Dowelled	Self-close	150
GTIOF034139399228	GT292	42/45mm	Impresso (Tool Free)	Self-close	150
Overlay Hinges (Cranking 03) - Up to 3/4" (19mm) Overlay					
GTIOF045138308228	GT310	42mm	Dowelled	Self-close	150
GTIOF045138486228	GT122	45mm	Screw-On	Self-close	150
GTIOF045138490228	GT123	45mm	Dowelled	Self-close	150
GTIOF034139400228	GT293	42/45mm	Impresso (Tool Free)	Self-close	150
Half Overlay Hinges (Cranking 9.5)					
GTIOF045138309228	GT311	42mm	Dowelled	Self-close	150
GTIOF045138487228	GT126	45mm	Screw-On	Self-close	150
GTIOF045138491228	GT127	45mm	Dowelled	Self-close	150



Angle Restriction Clip			
Item #	Quick Code	Description	Box Qty
GTIOF072135751517	GT224	Reduces opening angle to 85°	50



Accessory Items	
Item #	Description
AN203351	35mm Hinge Boring Bit
AN301008	8mm LH Bit, 57mm L

GRASS TIOMOS EURO HINGES

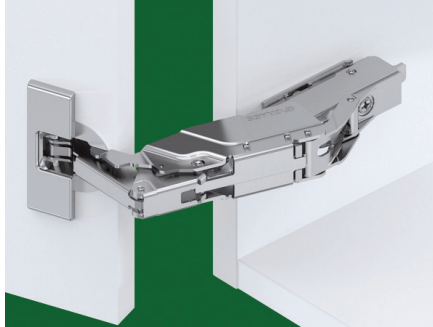

155° Tiomos Self-Closing Hinges

- 3-dimensional adjustment with suitable baseplate
- For face frame or frameless cabinets
- Convenient depth adjustment with worm gear



Item #	Quick Code	Boring Pattern	Fixing	Close Type	Box Qty
Full Overlay Hinges (Cranking 00) - Up to 7/8" (22mm) Overlay					
GTIOF045138320217	GT312	42mm	Dowelled	Self-close	50
GTIOF045138499217	GT130	45mm	Screw-On	Self-close	50
GTIOF045138502217	GT131	45mm	Dowelled	Self-close	50
GTIOF034139406217	GT298	42/45mm	Impresso (Tool Free)	Self-close	50
Overlay Hinges (Cranking 03) - Up to 3/4" (19mm) Overlay					
GTIOF045138321217	GT313	42mm	Dowelled	Self-close	50
GTIOF045138500217	GT134	45mm	Screw-On	Self-close	50
GTIOF045138503217	GT135	45mm	Dowelled	Self-close	50
GTIOF034139407217	GT299	42/45mm	Impresso (Tool Free)	Self-close	50
Half Overlay Hinges (Cranking 9.5)					
GTIOF045138322217	GT314	42mm	Dowelled	Self-close	50
GTIOF045138501217	GT138	45mm	Screw-On	Self-close	50
GTIOF045138504217	GT139	45mm	Dowelled	Self-close	50

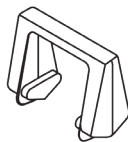

Angle Restriction Clip			
Item #	Quick Code	Description	Box Qty
GTIOF072135753117	GT225	Reduces opening angle to 120°	50



Accessory Items	
Item #	Description
AN203351	35mm Hinge Boring Bit
AN301008	8mm LH Bit, 57mm L

A
B
C
D
E
F
G
H
I
J
K
L
M
N
O
P
Q
R
S
T
U
V
W
X
Y

A GRASS TIOMOS EURO HINGES

B
C
D
E
F
G
H
I
J
K
L
M
N
O
P
Q
R
S
T
U
V
W
X
Y



Tiomos 95° Hinges for Thick Doors



- 3-dimensional adjustment with suitable baseplate
- Accommodates overlays up to 24mm (15/16")
- For door thicknesses up to 36mm (1-7/16")
- For face frame or frameless cabinets
- Convenient depth adjustment with worm gear

Item #	Quick Code	Boring Pattern	Fixing	Close Type	Box Qty
Full Overlay Hinges (Cranking 00) - Up to 7/8" (22mm) Overlay					
GTIOF045138509228	GT324	45mm	Dowelled	Self-close	150
GTIOF034139409228	GT301	42/45mm	Impresso (Tool Free)	Self-close	150
Overlay Hinges (Cranking 03) - Up to 3/4" (19mm) Overlay					
GTIOF045138328228	GT316	42mm	Dowelled	Self-close	150
GTIOF045138506228	GT321	45mm	Screw-On	Self-close	150
Half Overlay Hinges (Cranking 9.5)					
GTIOF045138329228	GT317	42mm	Dowelled	Self-close	150
GTIOF045138507228	GT322	45mm	Screw-On	Self-close	150
GTIOF045138511228	GT326	45mm	Dowelled	Self-close	150
Inset Hinges (Cranking 19)					
GTIOF045138508228	GT323	45mm	Screw-On	Self-close	150
GTIOF034139412228	GT304	42/45mm	Impresso (Tool Free)	Self-close	150



Cover Caps			
Item #	Quick Code	Finish	Box Qty
GTIOF072135500247	GT221	Steel, Nickel-Plated	1000

Hinge Cup Cover Cap			
Item #	Quick Code	Finish	Box Qty
GTIOF072135503228	GT223	Steel, Nickel-Plated	150

#6 x 5/8" FHP Screw		
Item #	Finish	Box Qty
G81001-43	Steel, Nickel-Plated	500

GRASS TIOMOS SPECIALTY HINGES

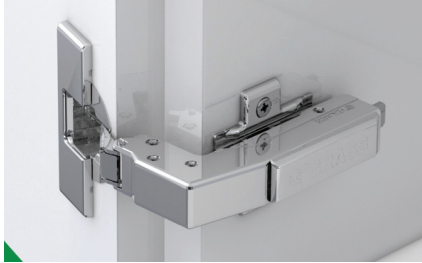

Tiomos 110/90A - 110° Blind Corner Hinges for Overlay Doors



- For blind corner construction
- 110° opening angle
- 3-dimensional adjustment with suitable baseplate
- Soft-close or Self-close hinges available
- Convenient depth adjustment with worm gear

Item #	Quick Code	Boring Pattern	Fixing	Close Type	Box Qty
GTIOF045138483223	GT143	45mm	Dowelled	Self-close	100
GTIOF028138535223	GT140	45mm	Screw-On	Soft-close	100
GTIOF028138545223	GT141	45mm	Dowelled	Soft-close	100
GTIOF034139397223	GT290	42/45mm	Impresso (Tool Free)	Self-close	100



Tiomos 110/90E - 110° Blind Corner Hinges for Inset Doors



- For blind corner construction
- 110° opening angle
- 3-dimensional adjustment with suitable baseplate
- Soft-close or Self-close hinges available
- Convenient depth adjustment with worm gear

Item #	Quick Code	Boring Pattern	Fixing	Close Type	Box Qty
GTIOF045138474223	GT146	45mm	Screw-On	Self-close	25
GTIOF045138484223	GT147	45mm	Dowelled	Self-close	100
GTIOF028138536223	GT144	45mm	Screw-On	Soft-close	100
GTIOF028138546223	GT145	45mm	Dowelled	Soft-close	100
GTIOF034139398223	GT291	42/45mm	Impresso (Tool-Less)	Self-close	25
GTIOF017139427223	GT244	42/45mm	Impresso (Tool-Less)	Soft-close	100



Cover Caps			
Item #	Quick Code	Finish	Box Qty
GTIOF072135500247	GT221	Steel, Nickel-Plated	1000

Hinge Cup Cover Cap			
Item #	Quick Code	Finish	Box Qty
GTIOF072135503228	GT223	Steel, Nickel-Plated	150

#6 x 5/8" FHP Screw		
Item #	Finish	Box Qty
G81001-43	Steel, Nickel-Plated	500

A
B
C
D
E
F
G
H
I
J
K
L
M
N
O
P
Q
R
S
T
U
V
W
X
Y

A GRASS TIOMOS SPECIALTY HINGES

B
C
D
E
F
G
H
I
J
K
L
M
N
O
P
Q
R
S
T
U
V
W
X
Y



Tiomos 110/30A - (+30° Angle Corner Hinges for Overlay Doors)



- For 30° angle corner cabinets
- 110° opening angle
- 3-dimensional adjustment with suitable baseplate
- Convenient depth adjustment with worm gear

Item #	Quick Code	Boring Pattern	Fixing	Close Type	Box Qty
GTIOF045138467223	GT149	45mm	Screw-On	Self-close	100



Tiomos 110/30E - (+30° Angle Corner Cabinet Hinges for Inset Doors)



- For 30° angle corner cabinets
- 110° opening angle
- 3-dimensional adjustment with suitable baseplate
- Convenient depth adjustment with worm gear

Item #	Quick Code	Boring Pattern	Fixing	Close Type	Box Qty
GTIOF028138530223	GT150	45mm	Screw-On	Self-close	100



Cover Caps			
Item #	Quick Code	Finish	Box Qty
GTIOF072135500247	GT221	Steel, Nickel-Plated	1000

Hinge Cup Cover Cap			
Item #	Quick Code	Finish	Box Qty
GTIOF072135503228	GT223	Steel, Nickel-Plated	150

#6 x 5/8" FHP Screw		
Item #	Finish	Box Qty
G81001-43	Steel, Nickel-Plated	500

GRASS TIOMOS SPECIALTY HINGES

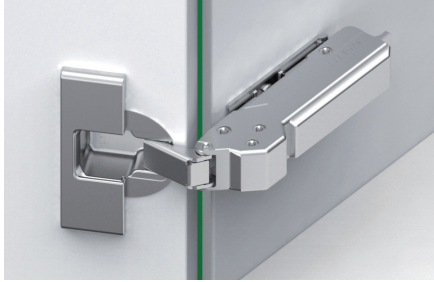

Tiomos 110/45A - (+45° Angle Corner Cabinet Hinges for Overlay Doors)



- For 45° angle corner cabinets
- 110° opening angle
- 3-dimensional adjustment with suitable baseplate
- Convenient depth adjustment with worm gear

Item #	Quick Code	Boring Pattern	Fixing	Close Type	Box Qty
GTIOF028138533223	GT158	45mm	Screw-On	Soft-close	100
GTIOF028138543223	GT159	45mm	Dowelled	Soft-close	100
GTIOF017139424223	GT241	45mm	Impresso (Tool-Less)	Soft-close	100



Tiomos 110/45E - (+45° Angle Corner Cabinet Hinges for Inset Doors)



- For 45° angle corner cabinets
- 110° opening angle
- 3-dimensional adjustment with suitable baseplate
- Soft-close or Self-close hinges available
- Convenient depth adjustment with worm gear

Item #	Quick Code	Boring Pattern	Fixing	Close Type	Box Qty
GTIOF045138472223	GT164	45mm	Screw-On	Self-close	25
GTIOF045138482223	GT165	45mm	Dowelled	Self-close	100
GTIOF028138544223	GT163	45mm	Dowelled	Soft-close	100
GTIOF017139425223	GT242	42/45mm	Impresso (Tool-less)	Soft-close	25



Cover Caps			
Item #	Quick Code	Finish	Box Qty
GTIOF072135500247	GT221	Steel, Nickel-Plated	1000

Hinge Cup Cover Cap			
Item #	Quick Code	Finish	Box Qty
GTIOF072135503228	GT223	Steel, Nickel-Plated	150

#6 x 5/8" FHP Screw		
Item #	Finish	Box Qty
G81001-43	Steel, Nickel-Plated	500

A
B
C
D
E
F
G
H
I
J
K
L
M
N
O
P
Q
R
S
T
U
V
W
X
Y

A GRASS TIOMOS SPECIALTY HINGES

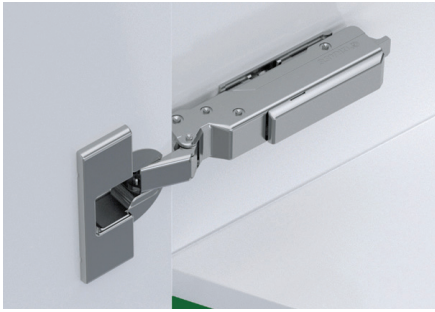

Tiomos 120/-15A (-15° Angle Corner Cabinet Hinges for Overlay Doors)



- For -15° angle corner cabinets
- 120° opening angle
- 3-dimensional adjustment with suitable baseplate
- Convenient depth adjustment with worm gear

Item #	Quick Code	Boring Pattern	Fixing	Close Type	Box Qty
GTIOF045138493223	GT167	45mm	Screw-On	Self-close	100
GTIOF017139432223	GT248	42/45mm	Impresso (Tool-less)	Soft-close	100



Tiomos 120/-45A (-45° Angle Corner Cabinet Hinges for Overlay Doors)



- For -45° angle corner cabinets
- 120° opening angle
- 3-dimensional adjustment with suitable baseplate
- Soft-close or Self-close hinges available
- Convenient depth adjustment with worm gear

Item #	Quick Code	Boring Pattern	Fixing	Close Type	Box Qty
GTIOF045138495223	GT171	45mm	Screw-On	Self-close	25
GTIOF028138557213	GT336	45mm	Screw-On	Soft-close	25
GTIOF034139405223	GT297	42/45mm	Impresso (Tool-less)	Self-close	100



Cover Caps

Item #	Quick Code	Finish	Box Qty
GTIOF072135500247	GT221	Steel, Nickel-Plated	1,000



Hinge Cup Cover Cap

Item #	Quick Code	Finish	Box Qty
GTIOF072135503228	GT223	Steel, Nickel-Plated	150



#6 x 5/8" FHP Screw

Item #	Finish	Box Qty
G81001-43	Steel, Nickel-Plated	500

GRASS TIOMOS SPECIALTY HINGES



Tiomos M9 110° Hinge for 12mm-28mm Door Thicknesses



- Accommodates overlays up to 25mm (1")
- For door thicknesses from 12mm (15/32") to 28mm (1-1/8")
- For face frame or frameless cabinets
- 3-dimensional adjustments with suitable baseplate
- Shallow cup depth of 9mm
- Compatible with Tiomos baseplates

Item #	Quick Code	Boring Pattern	Fixing	Close Type	Box Qty
GTIOF029140338217	GT125	45mm	Screw-On	Soft-close	50

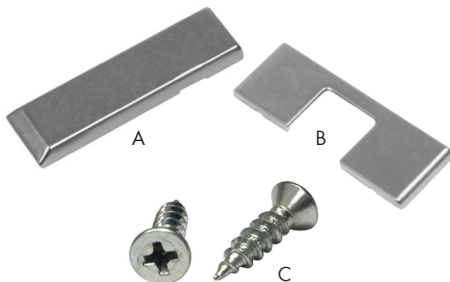

Item #	Quick Code	Finish	Box Qty
Cover Caps			
A	GTIOF072135500247	Steel, Nickel-Plated	1,000
Hinge Cup Cover Cap			
B	GTIOF072135503228	Steel, Nickel-Plated	150
#6 x 5/8" FHP Screw			
C	G81001-43	Steel, Nickel-Plated	500



Tiomos M0 125° Hinge for Thin Doors (6-10mm)



- No cup hole necessary
- Door thickness of 6mm (1/4") to 10mm (3/8")
- Accommodates door overlays up to 25.4mm (1")
- Works with a variety of door material - wood, aluminum, MDF, mineral composite, HPL (laminate), chipboard, and solid surface
- Special fasteners for hinge attachment to door
- Compatible with Tiomos baseplates

Item #	Boring Pattern	Fixing Type	Closing Type	Box Qty
GTIOF029140331217	45mm	Screw-On	Soft-Close	50

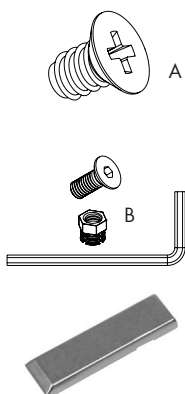

Fastening Options			Box Qty
Item #	Description		
A	<ul style="list-style-type: none"> • Countersunk screw PH2, M5 x 6mm • For a minimum door thickness of 6mm • For aluminum, HPL, and mineral composite 		1
B	<ul style="list-style-type: none"> • Countersunk screw M4 x 8mm, sleeve M4 x 5.5mm, internal hex key • For a min door thickness of 8mm, for chipboard, MDF, mineral composite, and HPL 		1

Cover Caps			
Item #	Quick Code	Finish	Box Qty
GTIOF072135500247	GT221	Steel, Nickel-Plated	1000

A
B
C
D
E
F
G
H
I
J
K
L
M
N
O
P
Q
R
S
T
U
V
W
X
Y

A GRASS TIOMOS SPECIALTY HINGES

B
C
D
E
F
G
H
I
J
K
L
M
N
O
P
Q
R
S
T
U
V
W
X
Y

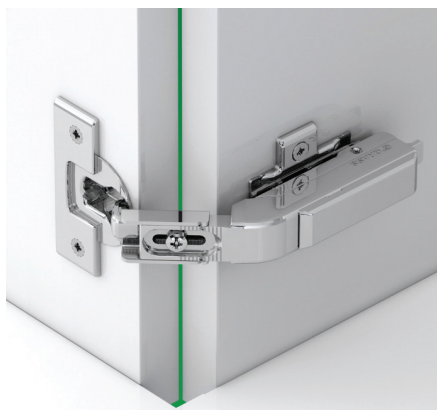

Tiomos PCC Pie-Cut Corner Cabinet Hinge



- 3-dimensional adjustment with suitable baseplate
- Designed for connecting two folding doors in corner cabinet
- For door thicknesses 16 to 24 mm
- Used in conjunction with Tiomos 155° hinges
- 35mm full cup drill hole

Hinges					
Item #	Quick Code	Boring Pattern	Fixing	Close Type	Box Qty
GTIOF045138336228	GT319	42mm	Dowelled	Self-close	150
GTIOF045138517228	GT172	45mm	Screw-On	Self-close	150
GTIOF045138518228	GT173	45mm	Dowelled	Self-close	150



Cover Caps			
Item #	Quick Code	Finish	Box Qty
GTIOF072135500247	GT221	Steel, Nickel-Plated	1,000



Hinge Cup Cover Cap			
Item #	Quick Code	Finish	Box Qty
GTIOF072135503228	GT223	Steel, Nickel-Plated	150



#6 x 5/8" FHP Screw		
Item #	Finish	Box Qty
G81001-43	Steel, Nickel-Plated	500

GRASS TIOMOS SPECIALTY HINGES

A
B
C
D
E
F
G
H
I
J
K
L
M
N
O
P
Q
R
S
T
U
V
W
X
Y



Tiomos H Hinges - 105° Hidden Hinges



- Hidden hinge is fully recessed in cabinet
- 105° opening angle
- Integrated soft-close damper
- 3-dimensional cam adjustments
- Minimum door thickness: 21/32" (18mm)
- Maximum door thickness: 1-1/4" (32mm)
- Door recess depth: 19/32" (15mm)
- Cabinet recess depth: 1-21/32" (42mm)
- Load-bearing capacity of 26.5lb (12kg)
- Available in Nickel-plated and Night finishes
- 10 polybag sets per box

Item #	Description
GTIOF051139126507	Diecast Nickel-Plated Screw-on "H" Hinge*
GTIOF051139125507	Diecast Night Screw-on "H" Hinge*

* Includes 2 hinges, 2 cover caps, and mounting hardware

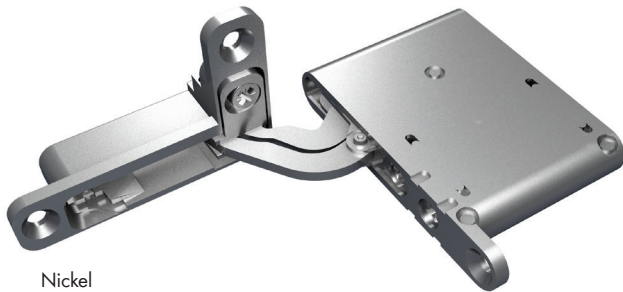

Nickel

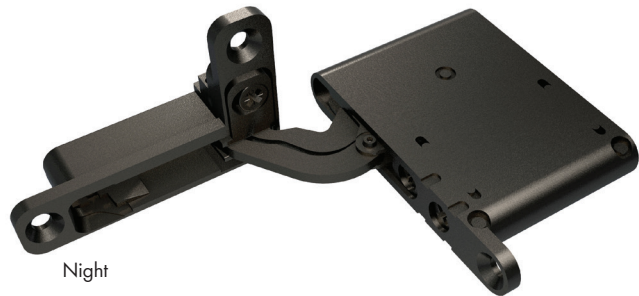

Night

Adjustment Options:

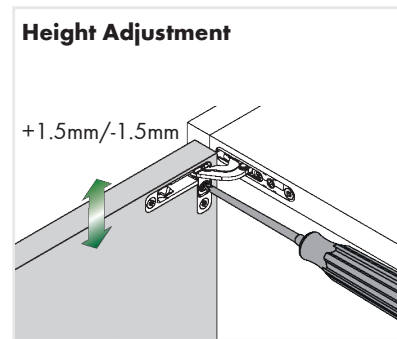
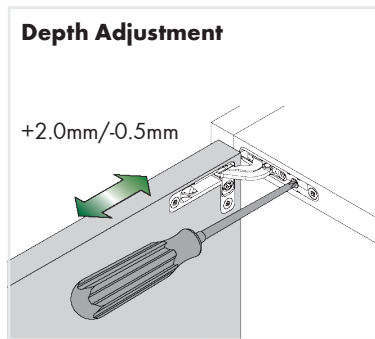
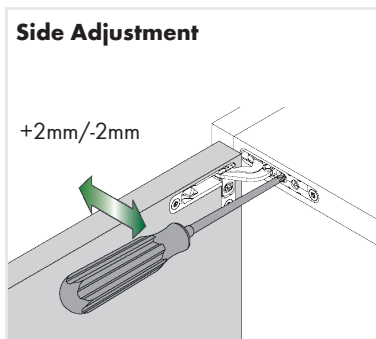

A GRASS TIOMOS WING BASEPLATES

B
C
D
E
F
G
H
I
J
K
L
M
N
O
P
Q
R
S
T
U
V
W
X
Y

Tiomos Wing Baseplates



- Steel, Nickel Plated
- Depth adjustment via worm gear
- Height adjustment via worm gear or elongated hole
- Side adjustment via hinge

A

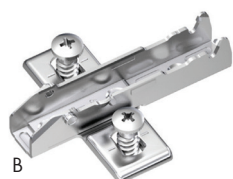

B

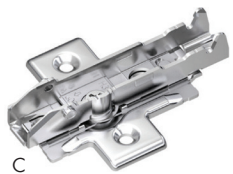

C



D



E



F

Item #	Quick Code	Height	Fixing Type	# of Fixing Points	Box Qty	
Standard One-Piece Mounting Plates - Height Adjustment via Elongated Screw Holes						
A	GTIOF058139721228	GT194	0mm	Wood Screws	3	150
	GTIOF058139722228	GT195	2mm	Wood Screws	3	150
	GTIOF058139723228	GT196	3mm	Wood Screws	3	150
B	GTIOF058139736228	GT198	0mm	Pre-mounted Euro Screws (13.5mm)	3	150
	GTIOF058139737228	GT199	2mm	Pre-mounted Euro Screws (13.5mm)	3	150
	GTIOF058139738228	GT200	3mm	Pre-mounted Euro Screws (13.5mm)	3	150
Cam Adjustable Wing Mounting Plates - Height Adjustment via Worm Gear						
C	GTIOF058139746228	GT174	0mm	Wood Screws	4	150
	GTIOF058139747228	GT175	2mm	Wood Screws	4	150
	GTIOF058139748228	GT176	3mm	Wood Screws	4	150
	GTIOF058139749228	GT177	3.5mm	Wood Screws	4	150
D	GTIOF058139756228	GT178	0mm	Euro Screws	4	150
	GTIOF058139757228	GT179	2mm	Euro Screws	4	150
	GTIOF058139758228	GT180	3mm	Euro Screws	4	150
	GTIOF058139759228	GT181	3.5mm	Euro Screws	4	150
E	GTIOF058139761228	GT182	0mm	Pre-mounted Euro Screws (13.5mm)	4	150
	GTIOF058139762228	GT183	2mm	Pre-mounted Euro Screws (13.5mm)	4	150
	GTIOF058139763228	GT184	3mm	Pre-mounted Euro Screws (13.5mm)	4	150
	GTIOF058139764228	GT185	3.5mm	Pre-mounted Euro Screws (13.5mm)	4	150
	GTIOF058139863228	GT186	0mm	Pre-mounted Euro Screws (10mm)	4	150
	GTIOF058139864228	GT187	2mm	Pre-mounted Euro Screws (10mm)	4	150
	GTIOF058139865228	GT188	3mm	Pre-mounted Euro Screws (10mm)	4	150
	GTIOF058139866228	GT189	3.5mm	Pre-mounted Euro Screws (10mm)	4	150
F	GTIOF058139766228	GT337	0mm	Expanding Dowels (5mm)	4	150
	GTIOF058139767228	GT338	2mm	Expanding Dowels (5mm)	4	150
	GTIOF058139768228	GT339	3mm	Expanding Dowels (5mm)	4	150



Accessory Items	
Item #	Description
AN608520	Vix Bit, 1/4" Hex Shank, #6 Screw
AN630520	Replacement Bit for above

GRASS TIOMOS THICK & INLINE BASEPLATES



Timos Thick Baseplates & Inline Baseplates

- Steel, Nickel Plated
- Depth adjustment via worm gear
- Height adjustment via worm gear or elongated hole
- Side adjustment via hinge

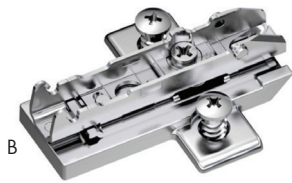

Item #	Quick Code	Height	Fixing Type	# of Fixing Points	Box Qty	
Cam Adjustable Thick Wing Plates - Height Adjustment via Worm Gear						
A	GTIOF058139892217	GT329	6mm	Wood Screws	2	50
	GTIOF058139888217	GT328	9.5mm	Wood Screws	2	50
	GTIOF058139893217	GT330	12mm	Wood Screws	2	50
	GTIOF058139894217	GT331	19mm	Wood Screws	2	50
	GTIOF058139895217	GT340	21mm	Wood Screws	2	50
B	GTIOF058139873217	GT190	6mm	Pre-mounted Euro Screws (13.5mm)	2	50
	GTIOF058139882217	GT191	9.5mm	Pre-mounted Euro Screws (13.5mm)	2	50
	GTIOF058139874217	GT192	12mm	Pre-mounted Euro Screws (13.5mm)	2	50
	GTIOF058139875217	GT193	19mm	Pre-mounted Euro Screws (13.5mm)	2	50
	GTIOF058139896217	GT341	21mm	Pre-mounted Euro Screws (13.5mm)	2	50
Cam Adjustable Inline Plates - Height Adjustment via Worm Gear						
C	GTIOF059139701228	GT204	0mm	Wood Screws	2	150
	GTIOF059139702228	GT205	2mm	Wood Screws	2	150
	GTIOF059139703228	GT206	3mm	Wood Screws	2	150
D	GTIOF059139711228	GT207	0mm	Pre-mounted Euro Screws (13.5mm)	2	150
	GTIOF059139713228	GT209	3mm	Pre-mounted Euro Screws (13.5mm)	2	150



Accessory Items	
Item #	Description
AN608520	Vix Bit, 1/4" Hex Shank, #6 Screw
AN630520	Replacement Bit for above

A
B
C
D
E
F
G
H
I
J
K
L
M
N
O
P
Q
R
S
T
U
V
W
X
Y

A GRASS TIOMOS FACE FRAME ADAPTER PLATES

B
C
D
E
F
G
H
I
J
K
L
M
N
O
P
Q
R
S
T
U
V
W
X
Y



Timos Face Frame Adapter Plates



- Steel, Nickel Plated
- Depth adjustment via worm gear
- Height adjustment via worm gear or elongated hole
- Side adjustment via hinge



Item #	Quick Code	Height	Fixing Type	# of Fixing Points	Box Qty	
Standard One-Piece Face Frame Adapter Plates - Height Adjustment via Elongated Screw Holes						
A	GTIOF058139821228	GT210	1.5mm	Wood Screws	2	150
	GTIOF058139822228	GT211	3.5mm	Wood Screws	2	150
B	GTIOF058139829228	GT218	3.5mm	Wood Screws - with Flange	4	150
	GTIOF058139830228	GT219	5mm	Wood Screws - with Flange	4	150
Cam Adjustable Face Frame Adapter Plates - Height Adjustment via Worm Gear						
C	GTIOF058139825228	GT214	1.5mm	Wood Screws	2	150
	GTIOF058139826228	GT215	3.5mm	Wood Screws	2	150
	GTIOF058139827228	GT216	4.5mm	Wood Screws	2	150
	GTIOF058139828228	GT217	5mm	Wood Screws	2	150
Inset Face Frame Adapter Plate - Height Adjustment via Worm Gear						
D	GTIOF058139831228	GT220	0mm	Wood Screws	3	150

Accessory Items	
Item #	Description
AN608520	Vix Bit, 1/4" Hex Shank, #6 Screw
AN630520	Replacement Bit for above



Screws for Hinges & Baseplates, Flat Head



- Sold by the box

Length x Gauge	Drive	Box Qty	Item #	Quick Code	Box Qty	Item #	Quick Code
Nickel Finish							
1/2" x 6	Phillips	1,000	WUMS6X12FCPNT	L54200	5,000	WUMS6X12FCPNB	L54300
5/8" x 6	Phillips	1,000	WUMS6X58FCPNT	L54375	5,000	WUMS6X58FCPN5B	L54380
3/4" x 6	Phillips	1,000	WUMS6X34FCPNT	L54680	5,000	WUMS6X34FCPNB	L54690
Zinc Finish							
1/2" x 6	Phillips	1,000	WUMS6X12FCPZT	L42100	5,000	WUMS6X12FCZB	L42150
5/8" x 6	Phillips	1,000	WUMS6X58FCPZT	L42300	5,000	WUMS6X58FCPZ5B	L42390
3/4" x 6	Phillips	1,000	WUMS6X34FCPZT	L42500	5,000	WUMS6X34FCZB	L43150



Screws for Face Frame Hinges, Modified Truss Head Type 17 Point

- Sold by the box

Length x Gauge	Drive	Box Qty	Item #	Quick Code
3/4" x 8	Phillips	1,000	WUMS8X34MCPNPT	L46300
3/4" x 10	Phillips	1,000	WUMS10X34PPCSNT	L45820

GRASS TIOMOS HINGE ACCESSORIES



+5° Wedge for Screw Fixing



- Zinc, nickel plated
- For placing under wing mounting plates
- Can be stacked (max. 3)

Item #	Quick Code	Height	Fixing Type	Box Qty
GTIOF072135757217	GT202	3mm	For Wood Screws	50

A
B
C
D
E
F
G
H
I
J
K
L
M
N
O
P
Q
R
S
T
U
V
W
X
Y



-5° Wedge for Screw Fixing



- Zinc, nickel plated
- For placing under wing mounting plates
- Cannot be stacked

Item #	Quick Code	Height	Fixing Type	Box Qty
GTIOF072135758217	GT203	3mm	For Wood Screws	50



Angle Reduction Clip to 120° - For 155° Tiomos Hinges



- Plastic, black

Item #	Box Qty
GTIOF072135753517	50



Angle Reduction Clip to 85° - For 110° and 120° Tiomos Hinges



- Works for all TIOMOS 110° and 120° standard hinges
- Reduces the opening angle to 85° to prevent doors from bumping the cabinet side in inset or mitered corner applications

Item #	Quick Code	Finish	Box Qty
GTIOF072135751517	GT224	Steel, Nickel-Plated	50

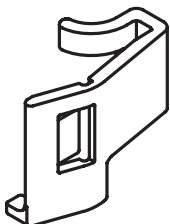

Hinge Clip Protector



- Prevents accidental release of the hinge from the baseplate
- For use in lockers, wardrobes, office furniture, or similar applications

Item #	Finish	Box Qty
GF072135807540	Steel, Nickel-Plated	500

A GRASS TIOMOS HINGE ACCESSORIES

B
C
D
E
F
G
H
I
J
K
L
M
N
O
P
Q
R
S
T
U
V
W
X
Y



Hinge Arm Cover Cap



- For all Tiomos crankings
- Steel, nickel-plated

Item #	Quick Code	Box Qty
GTIOF072135500247	GT221	1,000



Hinge Arm Cover Cap, Long



- For Tiomos 00 and 03 crankings only

Item #	Quick Code	Box Qty
GTIOF072135504247	GT222	1,000



Hinge Cup Cover Cap



- Steel, nickel-plated

Item #	Quick Code	Box Qty
GTIOF072135503228	GT223	150



Euro Screws, Nickel-Plated



Item #	Description	Box Qty
G81015	13mm Euro Screw (1/2")	500
G83000	18mm Euro Screw (1 1/16")	500
G83001-43	7.5mm Euro Screw (5/16")	500



Wood Screws, Nickel-Plated



Item #	Description	Box Qty
G81014-43	#6 x 1/2" FHP Wood Screw	500
G81001-43	#6 x 5/8" FHP Wood Screw	500
G6X34FHNI	#6 x 3/4" FHP Wood Screw	500



Pozidrive Screwdriver



Item #	Description	Box Qty
GPD	#2 Pozidrive Screwdriver for Hinges	1

GRASS TIOMOS TIPMATIC



Tiomos 110° Tipmatic Plus Hinges for Handle-Free Doors



- Integrated spring in hinge arm assists Tipmatic Pin for handle-free door opening
- Extended opening angle
- Works with Tipmatic Pin system
- 3 dimensional adjustment with suitable baseplate
- Compatible with all Tiomos baseplates

Item #	Overlay	Boring Pattern	Box Qty
GTIOF046140360213	Overlay (Cranking 03)	45mm	25
GTIOF046140366213	Inset (Cranking 19)	45mm	25



Cover Caps			
Item #	Quick Code	Finish	Box Qty
GTIOF072135500247	GT221	Steel, Nickel-Plated	1,000



Opening Angle Reduction Clip to 85°			
Item #	Quick Code	Finish	Box Qty
GTIOF072135751517	GT224	Steel, Nickel-Plated	50



Hinge Cup Cover Cap			
Item #	Quick Code	Finish	Box Qty
GTIOF072135503228	GT223	Steel, Nickel-Plated	150



#6 x 5/8" FHP Screw		
Item #	Finish	Box Qty
G81001-43	Steel, Nickel-Plated	500

A
B
C
D
E
F
G
H
I
J
K
L
M
N
O
P
Q
R
S
T
U
V
W
X
Y

A GRASS TIOMOS TIPMATIC



Tipmatic for Handle-Free Wooden Doors



- Gently tapping the front causes the doors to open to a convenient angle
- Any free-swing hinges can be used
- Large magnet catch range – closes doors reliably
- Gap adjustment from 2.5 to 5.5 mm with integrated, self-locking and tool-less depth adjustment feature
- Mount on the front side of the cabinet or with an adapter plate

B
C
D
E
F
G
H
I
J
K
L
M
N
O
P
Q
R
S
T
U
V
W
X
Y



Tipmatic Pin



- Includes Tipmatic mechanism (hole edge cover 1mm), Stick on strike plate, and screw on strike plate
- Hole drilled from the front
- Plastic RAL 7036, platinum grey

Item #	Box Qty
GF069135396513	25



Line Boring Adapter Plate



- Suitable for line boring 28mm and 37mm
- Attach with Euro Screws (6.3mm x 13.5mm)
- Plastic RAL 7035, light grey

Item #	Box Qty
GF069063310213	25



Linear Adapter Plate



- Design solution - also suitable for insets
- Attach with wood screws (3.5mm x 13mm)
- Plastic RAL 7035, light grey

Item #	Box Qty
GF069073696213	25

GRASS NEXIS EURO HINGES



110° Hinges for Standard Doors



- 3-dimensional adjustment with suitable baseplate
- Soft-close compatible
- Shallow cup depth: Nexis 11mm & Nexis Impresso 11.5mm
- Accommodates overlays up to 20mm (25/32")
- For face frame and frameless cabinets
- Combination drilling pattern for Nexis Impresso



Cover Caps	
Item #	Box Qty

Steel, Nickel-Plated Cover Cap for Nexis Full Overlay Hinges

A	GF069073683247	1,000
---	----------------	-------

Black Plastic Cover Cap for Nexis Full Overlay, Half Overlay and Inset Hinges

B	GNX924.200.40.0115	1,000
---	--------------------	-------

Item #	Boring Pattern	Fixing Type	Close Type	Box Qty
Full Overlay Hinges - Cranking 00				
GNX138.322.73.0015	42mm	Screw-On	Self-Close	250
GNX015072925236	42mm	Dowelled	Self-Close	250
GNX014072544225	42/45mm	Impresso (Tool-less)	Self-Close	125
GNX015072632236	45mm	Screw-On	Self-Close	250
GNX148.322.54.0015	45mm	Dowelled	Self-Close	250
GNX146.322.53.0015	48mm	Screw-On	Self-Close	250
GNX146.322.54.0015	48mm	Dowelled	Self-Close	250
G146.622.35.0015	45/48mm	Impresso (Tool-less)	Self-Close	125
Half Overlay Hinges - Cranking 08				
GNX015072934236	42mm	Screw-On	Self-Close	250
GNX138.322.74.0815	42mm	Dowelled	Self-Close	250
GNX014072547225	42/45mm	Impresso (Tool-less)	Self-Close	125
GNX148.322.53.0815	45mm	Screw-On	Self-Close	250
GNX148.322.54.0815	45mm	Dowelled	Self-Close	250
GNX015072818236	48mm	Screw-On	Self-Close	250
G146.622.35.0815	45/48mm	Impresso (Tool-less)	Self-Close	125
Inset Hinges - Cranking 15 - Opening Angle 100°				
GNX015072881236	42mm	Dowelled	Self-Close	250
GNX148.304.54.1515	45mm	Dowelled	Self-Close	100
G146.304.56.1515	48mm	Dowelled	Self-Close	250



85° Angle Reduction Clip - Black Plastic	
Item #	Box Qty
GF069135032547	1,000



#6 x 5/8" FHP Wood Screw, Nickel-Plated	
Item #	Box Qty
G81001-43	500

A
B
C
D
E
F
G
H
I
J
K
L
M
N
O
P
Q
R
S
T
U
V
W
X
Y

A GRASS NEXIS EURO HINGES



125° Hinges for Standard Doors



- 3-dimensional adjustment with suitable baseplate
- Soft-close compatible
- Accommodates overlays up to 19mm (3/4")
- For door thickness up to 19mm (3/4")
- Alternative solution for wide angle application
- For face frame and frameless cabinets
- Combination drilling pattern for Nexis Impresso

Item #	Boring Pattern	Fixing Type	Close Type	Box Qty
Full Overlay Hinges - Cranking 00				
GNX138.329.73.0015	42mm	Screw-On	Self-Close	250
GNX138.329.74.0015	42mm	Dowelled	Self-Close	250
GNX148.329.31.0015	45mm	Screw-On	Self-Close	250
GNX015072636236	45mm	Dowelled	Self-Close	250
GNX146.329.55.0015	48mm	Screw-On	Self-Close	250
GNX146.329.56.0015	48mm	Dowelled	Self-Close	250
GNX014072524225	45/48mm	Impresso (Tool-less)	Self-Close	125



Cover Caps			
	Item #	Description	Box Qty
A	GF069073683247	Steel, Nickel-Plated Cover Cap for Nexis Full Overlay Hinges	1,000
B	GNX924.200.40.0115	Black Plastic Cover Cap for Nexis Full Overlay, Half Overlay and Inset Hinges	1,000



#6 x 5/8" FHP Wood Screw, Nickel-Plated	
Item #	Box Qty
G81001-43	500

GRASS NEXIS EURO HINGES



170° Hinges for Standard Doors



- 3-dimensional adjustment with suitable baseplate
- Soft-close compatible
- Accommodates overlays up to 19mm (3/4")
- Shallow cup depth: 11mm for Nexis & Nexis Impresso
- Zero protrusion when door opened 90°
- Finger protection
- For face frame and frameless cabinets
- Combination drilling pattern for Nexis Impresso

Item #	Boring Pattern	Fixing Type	Close Type	Box Qty
Full Overlay Hinges - Cranking 00				
GNX138.765.73.0015	42mm	Screw-On	Self-Close	50
GNX138.765.74.0015	42mm	Dowelled	Self-Close	50
GF014072550217	42/45mm	Impresso (Tool-less)	Self-Close	50
GNX148.765.54.0015	45mm	Dowelled	Self-Close	50
G146.765.54.0015	48mm	Dowelled	Self-Close	50
G146.765.35.0015	45/48mm	Impresso (Tool-less)	Self-Close	50
Half Overlay Hinges - Cranking 08				
GNX015072957217	42mm	Dowelled	Self-Close	50
GNX148.765.53.0015	45mm	Screw-On	Self-Close	50



120° Angle Reduction Clip

- Black plastic
- Opening angle reduction to 120°
- Prevents doors bumping with the cabinet side in inset applications and mitered corner applications

Item #	Box Qty
G641.000.09.9862	250



#6 x 5/8" FHP Wood Screw, Nickel-Plated

Item #	Box Qty
G81001-43	500

A
B
C
D
E
F
G
H
I
J
K
L
M
N
O
P
Q
R
S
T
U
V
W
X
Y

A GRASS NEXIS EURO HINGES

B
C
D
E
F
G
H
I
J
K
L
M
N
O
P
Q
R
S
T
U
V
W
X
Y



Nexis 95° Hinges for Thick or Profile Doors



- 3-dimensional adjustment with suitable baseplate
- Soft-close compatible
- Accommodates overlays up to 19mm (3/4")
- Minimal gap dimensions on thick doors
- For door thickness up to 30mm (1-3/16")

Item #	Boring Pattern	Fixing Type	Close Type	Box Qty
Full Overlay Hinges - Cranking 00				
GNX015072889236	42mm	Screw-On	Self-close	250
Half Overlay Hinges - Cranking 08				
GNX015072762236	48mm	Screw-On	Free Swing	250



Nexis 95° Hinges with 40mm Cup for Profile Doors



- 3-dimensional adjustment with suitable baseplate
- Accommodates door overlays up to 23mm (7/8")
- Minimal gap dimensions on thick doors
- Excellent weight capacity for heavy profile doors
- For profile or frame doors up to 36mm thick
- Special spring mechanism ensures excellent closing force - even with large doors

Item #	Boring Pattern	Fixing Type	Close Type	Box Qty
Full Overlay Hinges - Cranking 00				
G146.425.53.0015	48mm	Screw-On	Self-close	125
Half Overlay Hinges - Cranking 08				
G146.425.53.0815	48mm	Screw-On	Self-close	125



Cover Caps			
Item #	Description	Box Qty	
A	GF069073683247	Steel, Nickel-Plated Cover Cap for Nexis Full Overlay Hinges	1,000
B	GNX924.200.40.0115	Black Plastic Cover Cap for Nexis Full Overlay, Half Overlay and Inset Hinges	1,000



#6 x 5/8" FHP Wood Screw, Nickel-Plated	
Item #	Box Qty
G81001-43	500

GRASS NEXIS SPECIALTY HINGES

A
B
C
D
E
F
G
H
I
J
K
L
M
N
O
P
Q
R
S
T
U
V
W
X
Y



Nexis PCC Pie-Cut Corner Hinges



- 3-dimensional adjustment with suitable baseplate
- Designed for connecting two folding doors in corner cabinet
- For door thicknesses 16 to 22mm
- Used in conjunction with Nexis 170° hinges

Item #	Boring Pattern	Fixing Type	Close Type	Box Qty
GNX015072653225	45mm	Dowelled	Self-Close	125
GNX015072858225	48mm	Screw-On	Self-Close	125
GNX146.700.02.0015	48mm	Dowelled	Self-Close	125



Nexis 21 PCC Pie-Cut Corner Hinges with Full Cup Recess



- 3-dimensional adjustment with suitable baseplate
- Designed for folding doors in corner cabinets
- For door thicknesses 24mm max, factory setting 19mm door thickness with 4mm drilling distance
- Used in conjunction with Nexis 170 hinges
- Shallow cup depth of 10.8mm

Item #	Boring Pattern	Fixing Type	Close Type	Box Qty
GNX015070139225	42mm	Screw-On	Self-close	125
GNX015070140225	42mm	Dowelled	Self-close	125



Item #	Description	Box Qty
GNX924.200.40.0115	Black Plastic Cover Cap for Nexis Full Overlay, Half Overlay and Inset Hinges	1,000



Item #	Description	Box Qty
G81001-43	#6 x 5/8" FHP Wood Screw, Nickel-Plated	500

A GRASS NEXIS SPECIALTY HINGES

B
C
D
E
F
G
H
I
J
K
L
M
N
O
P
Q
R
S
T
U
V
W
X
Y



95° Opening +45° Angle Corner Cabinet Hinges



- 3-dimensional adjustment with suitable baseplate
- Soft-close compatible
- Minimal gap dimensions on door thickness of up to 30mm
- For 45° angle corner cabinets
- Combination drilling pattern for Nexis Impresso

Item #	Boring Pattern	Fixing Type	Close Type	Box Qty
Inset				
GNX148.405.06.0315	45mm	Screw-On	Self-Close	125
GNX148.405.08.0315	45mm	Dowelled	Self-Close	125
G146.405.54.0315	48mm	Dowelled	Self-Close	125
G146.705.35.0315	45/48mm	Impresso (Tool-less)	Self-Close	125



95° Opening 90° Inset Post Hinge for Blind Corner Cabinets



- 3-dimensional adjustment with suitable baseplate
- Soft-close compatible
- Minimal gap dimensions on door thickness of up to 30mm

Item #	Boring Pattern	Fixing Type	Close Type	Box Qty
Inset				
GNX148.405.12.9615	45mm	Dowelled	Self-Close	125



Item #	Description	Box Qty
GNX924.200.40.0115	Black Plastic Cover Cap for Nexis Full Overlay, Half Overlay and Inset Hinges	1,000



Item #	Description	Box Qty
G81001-43	#6 x 5/8" FHP Wood Screw, Nickel-Plated	500

GRASS NEXIS SPECIALTY HINGES



975 VZ PCC Pie Cut Corner Hinge



- Small or large gap between door
- Shallow profile does not interfere with lazy susans
- Same drilling on both doors
- Height adjustable
- Accommodates doors 15 to 24mm thick

975 VZ Pie Cut Corner Hinge

Item #	Description	Finish	Box Qty
G13128-37	975 VZ Pie Cut Corner Hinge Kit	Zinc, Nickel-Plated	50

NOTE: Kit consists of (2) PCC hinges, (1) strike plate, (1) magnetic catch, and (1) instruction sheet

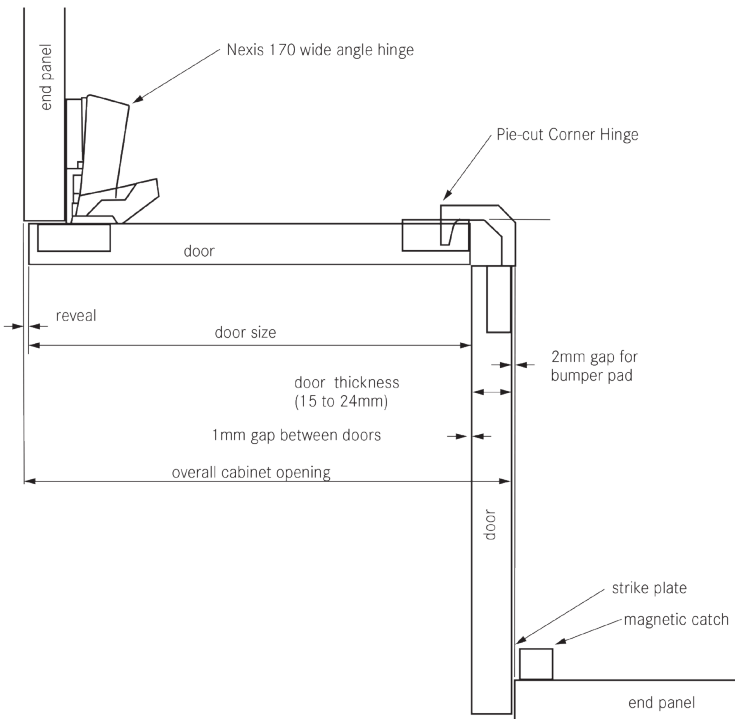

Door Sizing Example	
Overall cabinet opening	305mm
-Reveal	3mm
	= 302mm
-2mm gap for bumper pad	2mm
	=300mm
-Door Thickness	19mm
	=281mm
-1 mm Gap between doors	1 mm
Door size	=280mm

NOTE: Use a POZIdrive screwdriver for hinge adjustment.
Fastening screws for hinge: #6 x 5/8" FHP (not included)
Fastening screws for catch: #4 x 5/8" FHP (not included)

A
B
C
D
E
F
G
H
I
J
K
L
M
N
O
P
Q
R
S
T
U
V
W
X
Y

A GRASS NEXIS BASEPLATES

- Steel, nickel plated
- Depth and height adjustment via eccentric cam
- Side adjustment via hinge
- Use a #2 Pozi drive screwdriver for hinge adjustment

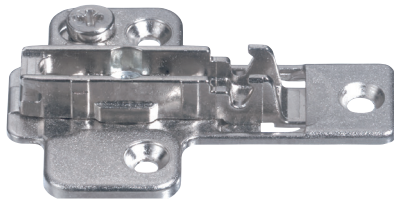

Cam Baseplates, 3-Point Fixing			
Item #	Height	Fixing Type	Box Qty
GF061073214236	0mm	For Wood Screws	250
G314.493.70.0215	2mm	For Wood Screws	250
G314.493.70.0415	4mm	For Wood Screws	250
G314.493.70.0815	8mm	For Wood Screws	250

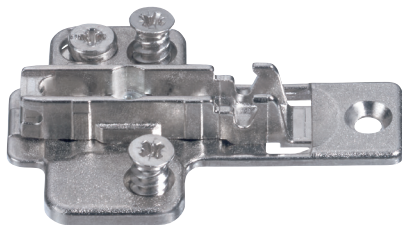

Cam Baseplates, 3-Point Fixing			
Item #	Height	Fixing Type	Box Qty
GF061073232236	0mm	Pre-Mounted Euro Screws	250
G318.493.70.0215	2mm	Pre-Mounted Euro Screws	250
G318.493.70.0815	8mm	Pre-Mounted Euro Screws	250

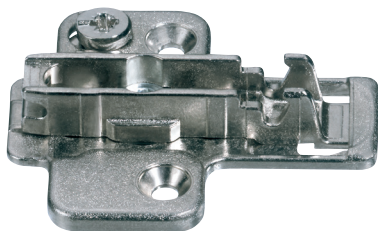

Cam Baseplates, 2-Point Fixing			
Item #	Height	Fixing Type	Box Qty
GNX314.493.71.0015	0mm	For Wood Screws	250
GF061073254236	2mm	For Wood Screws	250
GNX314.493.71.0415	4mm	For Wood Screws	250
GNX314.493.71.0815	8mm	For Wood Screws	250

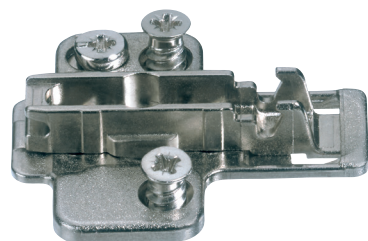

Cam Baseplates, 2-Point Fixing			
Item #	Height	Fixing Type	Box Qty
GNX318.493.71.0015	0mm	Pre-Mounted Euro Screws	250
GNX318.493.71.0215	2mm	Pre-Mounted Euro Screws	250
GNX318.493.71.0415	4mm	Pre-Mounted Euro Screws	250
GNX318.493.71.0615	6mm	Pre-Mounted Euro Screws	250
GNX318.493.71.0815	8mm	Pre-Mounted Euro Screws	250

GRASS NEXIS BASEPLATES



- Height adjustable
- Depth adjustment via hinge arm
- Side adjustment via hinge
- Use a #2 Pozi drive screwdriver for hinge adjustment
- Attach baseplates using all available screw holes

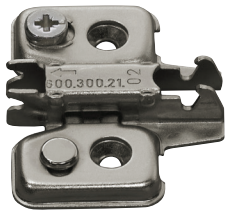

Cam Height Adjustable Baseplates, 2-Point Fixing

Item #	Height	Fixing Type	Finish	Box Qty
GNX314.393.81.0015	0mm	For Wood Screws	Steel, Nickel-Plated	250
GF060073143236	2mm	For Wood Screws	Steel, Nickel-Plated	250



Cam Height Adjustable Baseplates, 2-Point Fixing

Item #	Height	Fixing Type	Finish	Box Qty
GNX318.393.69.0015	0mm	Pre-Mounted Euro Screws	Steel, Nickel-Plated	250
GF060073177236	2mm	Pre-Mounted Euro Screws	Steel, Nickel-Plated	250

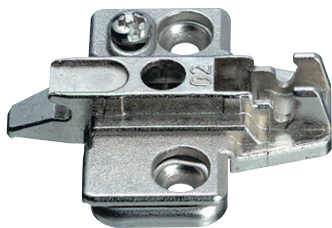

2-Piece Height Adjustable Baseplates, 3-Point Fixing

Item #	Height	Fixing Type	Finish	Box Qty
GNX315.393.55.0015	0mm	For Wood Screws	Steel/die-cast, Nickel-Plated	250
GNX315.393.55.0215	2mm	For Wood Screws	Steel/die-cast, Nickel-Plated	250
GNX315.393.55.0415	4mm	For Wood Screws	Steel/die-cast, Nickel-Plated	250
G315.393.55.0815	8mm	For Wood Screws	Steel/die-cast, Nickel-Plated	250

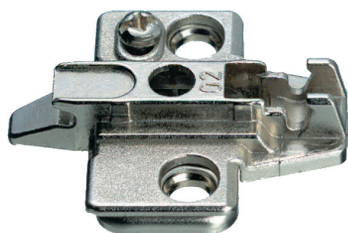

2-Piece Height Adjustable Baseplates, 3-Point Fixing

Item #	Height	Fixing Type	Box Qty
GNX317.393.56.0015	0mm	For Euro Screws	250
GNX317.393.56.0215	2mm	For Euro Screws	250

A
B
C
D
E
F
G
H
I
J
K
L
M
N
O
P
Q
R
S
T
U
V
W
X
Y

A GRASS NEXIS BASEPLATES

B
C
D
E
F
G
H
I
J
K
L
M
N
O
P
Q
R
S
T
U
V
W
X
Y

- Steel, nickel-plated
- Height adjustment via elongated screw holes
- Side adjustment via elongated hole
- Use a #2 Pozi drive screwdriver for hinge adjustment
- Attach baseplates using all available screw holes



Wing Steel Baseplate, 2-Point Fixing			
Item #	Height	Fixing Type	Box Qty
GF060073144236	0mm	For Wood Screws	250
GF060073145236	2mm	For Wood Screws	250
GF060073146236	4mm	For Wood Screws	250



Wing Steel Baseplate, 2-Point Fixing			
Item #	Height	Fixing Type	Box Qty
GNX318.393.81.0015	0mm	Pre-Mounted Euro Screws	250
GNX318.393.81.0215	2mm	Pre-Mounted Euro Screws	250
GNX318.393.81.0415	4mm	Pre-Mounted Euro Screws	250

WÜRTH LOUIS AND COMPANY IS YOUR ONE SOURCE FOR ALL OF YOUR WOODWORKING PROJECTS!

Service • Selection • Quality



GRASS NEXIS FACE FRAME BASEPLATES

- Use a #2 Pozi drive screwdriver for hinge adjustment
- Attach baseplates using all available screw holes

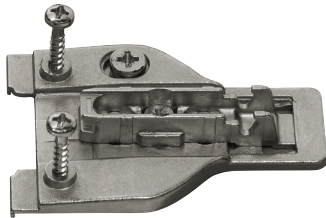

FFA Cam Baseplate

- Height and depth adjustment via eccentric cam

Item #	Height	Fixing Type	Box Qty
GNX346.290.92.0015	0mm	Pre-mounted Wood Screws	250
GNX346.290.92.0415	4mm	Pre-mounted Wood Screws	250

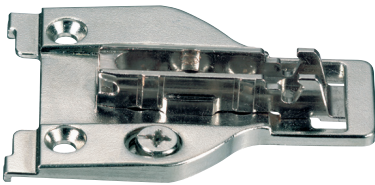

FFA Cam Baseplate

- Height and depth adjustment via eccentric cam



Item #	Height	Fixing Type	Box Qty
GNX346.290.91.0015	0mm	For Wood Screws	250
GNX346.290.91.0215	2mm	For Wood Screws	250
GF061073281236	4mm	For Wood Screws	250

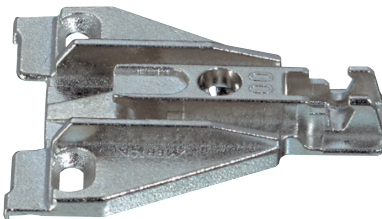

FFA Baseplate

- Height adjustment via elongated hole



Item #	Height	Fixing Type	Box Qty
GNX346.290.88.0015	0mm	For Wood Screws	250
GNX346.290.88.0415	4mm	For Wood Screws	250

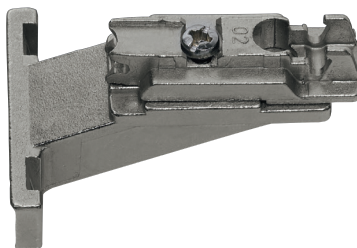

Inset FFA Baseplate

- For inset doors
- To be used with half overlay (cranking 08) hinges
- Height adjustment via screw



Item #	Height	Fixing Type	Box Qty
GNX346.290.90.0215	2mm	For Wood Screws	250

A
B
C
D
E
F
G
H
I
J
K
L
M
N
O
P
Q
R
S
T
U
V
W
X
Y

A SOFT-CLOSE ADAPTERS FOR NEXIS HINGES

B
C
D
E
F
G
H
I
J
K
L
M
N
O
P
Q
R
S
T
U
V
W
X
Y



For Nexis 95°, 100°, 110° and 125° Hinges



- Slows door action to close quietly
- Quick and easy to attach
- Completely tool-free
- Damping force can be individually adjusted
- Best suited for flat panel doors

Soft-Close Nexis Set

- Set consists of:
 - (1) Soft-close adapter with pre-mounted damper
 - (1) Cover cap for hinge cup
 - (2) Cover caps for hinge arm

Item #	Box Qty
GNX924.200.40.0215	125

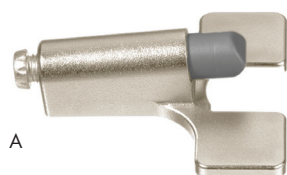
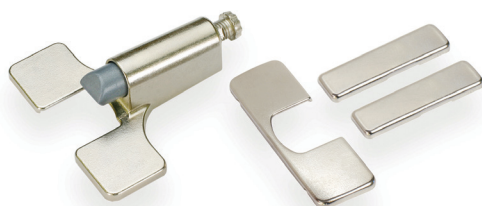

A

Soft-Close Nexis - Individual Parts			
	Item #	Description	Box Qty
A	GNX924.200.55.0115	Soft-Close Adapter	125
B	GF069073683247	Cover Caps for Hinges - Full Overlay (00 Cranking)	1,000



B

SOFT-CLOSE ADAPTERS FOR NEXIS IMPRESSO HINGES



For Nexis Impresso 95°, 100°, 110°, and 125° Hinges



- Soft-close adapter for Nexis Impresso hinges
- Slows door action to close quietly
- Quick and easy to attach
- Completely tool-free
- Damping force can be individually adjusted
- Best suited for flat panel doors

Soft-Close Impresso Set

Set Consists of:

- (1) Soft-close adapter for Nexis Impresso Hinges
- (1) Soft-close damper
- (2) Cover caps

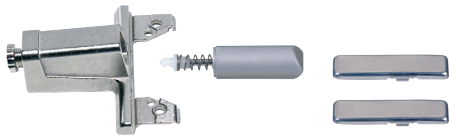

Item #	Box Qty
GSMG	125

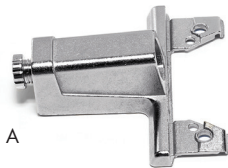

A



B



C

Soft-Close NEXIS Impresso - Individual Parts			
Item #	Description	Box Qty	
A	GF069073726225	Soft-close Impresso Adapter	125
B	G924.012.50.0142	Soft-close Damper	125
C	GF069073683247	Cover Caps for Hinges - Full Overlay (00 Cranking)	1,000



For Nexis Impresso 170° and Nexis 170° Wide-Angle Hinges



- Soft-close adapter for 170° wide-angle hinges
- Slows door action to close quietly
- Simply snap in place
- Completely tool-free
- Perfect retrofit solution



Item #	Box Qty
GNXF069073729225	125

A
B
C
D
E
F
G
H
I
J
K
L
M
N
O
P
Q
R
S
T
U
V
W
X
Y

A GRASS NEXIS HINGE ACCESSORIES



Cover Caps			
	Item #	Description	Box Qty
A	GF069073683247	Steel, Nickel-Plated Cover Cap for Nexis Full Overlay Hinges	1,000
B	GNX924.200.40.0115	Black Plastic Cover Cap for Nexis Full Overlay, Half Overlay and Inset Hinges	1,000



85° Angle Reduction Clip - Black Plastic	
Item #	Box Qty
GF069135032547	1,000



120° Angle Reduction Clip

- Black plastic
- Opening angle reduction to 120°
- Prevents doors bumping with the cabinet side in inset applications and mitered corner applications

Item #	Box Qty
G641.000.09.9862	1,000



#6 x 5/8" FHP Wood Screw, Nickel-Plated	
Item #	Box Qty
G81001-43	500

B
C
D
E
F
G
H
I
J
K
L
M
N
O
P
Q
R
S
T
U
V
W
X
Y

GRASS TEC 864 SOFT-CLOSE HINGES



108° Opening Angle - 1/4" to 1" Overlay



- Soft-close damper is pre-mounted in the hinge cup
- Adjustment switch to regulate closing action
- One piece hinge and baseplate combination
- 3 dimensional adjustment
- 11mm (7/16") cup drilling depth
- Front locating tabs position hinge on face frame
- Cam side adjustment
- Cam depth adjustment
- Height adjustment at mounting screw
- Works with current GRASS insertion machinery
- Made in the USA

Side-Mount - 45mm Boring Pattern

Item #	Overlay	Fixing Type	Box Qty
GTEC2750-15	1/2"	Dowelled	300
GTEC4423A-15	1/2"	Screw-On	300
GTEC1995A-15	5/8"	Dowelled	300

Side-Mount - 42mm Boring Pattern

Item #	Overlay	Fixing Type	Box Qty
GTEC2749-15	1/2"	Dowelled	300

Wrap-Around 45mm Boring Pattern

Item #	Overlay	Fixing Type	Box Qty
GTEC2791-15	1/4"	Dowelled	300
GTEC4429-15	1/4"	Screw-On	300
GTEC2858A-15	7/16"	Dowelled	300
GTEC2670A-15	7/16"	Screw-On	300
GTEC2870-15	1/2"	Dowelled	300
GTEC4431-15	1/2"	Screw-On	300
GTEC2875-15	3/4"	Dowelled	300
GTEC4432-15	3/4"	Screw-On	300
GTEC2745-15	1"	Dowelled	300
GTEC4441-15	1"	Screw-On	300

Wrap-Around 42mm Boring Pattern

Item #	Overlay	Fixing Type	Box Qty
GTEC2788-15	1/4"	Dowelled	300
GTEC02809A-15	7/16"	Dowelled	300
GTEC2824-15	1/2"	Dowelled	300
GTEC2825-15	3/4"	Dowelled	300
GTEC2834-15	1"	Dowelled	300

Angle Restriction Clip

- Reduces opening angle from 108° to 85°

Item #	Box Qty
G80125-42	100

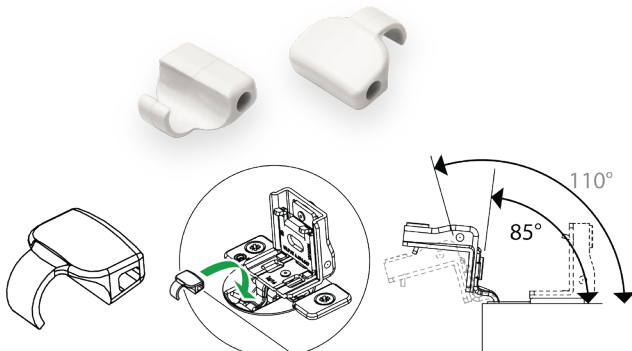

A
B
C
D
E
F
G
H
I
J
K
L
M
N
O
P
Q
R
S
T
U
V
W
X
Y

A GRASS TEC 864 SOFT-CLOSE HINGES



108° Opening Angle - 1-1/4" to 1-1/2" Overlay

- Soft-close damper is pre-mounted in the hinge cup
- Adjustment switch to regulate closing action
- One piece hinge and baseplate combination
- 3 dimensional adjustment
- 11 mm (7/16") cup drilling depth
- Front locating tabs position hinge on face frame
- Cam side adjustment
- Cam depth adjustment
- Height adjustment at mounting screw
- Works with current GRASS insertion machinery
- Made in the USA

Side-Mount - 45mm Boring Pattern

Item #	Overlay	Fixing Type	Box Qty
GTEC2780-15	1-1/4"	Dowelled	300
GTEC2785A-15	1-3/8"	Dowelled	300

Side-Mount - 42mm Boring Pattern

Item #	Overlay	Fixing Type	Box Qty
GTEC2838-15	1-1/4"	Dowelled	300

Wrap-Around 45mm Boring Pattern

Item #	Overlay	Fixing Type	Box Qty
GTEC2910-15	1-1/4"	Dowelled	300
GTEC4547-15	1-1/4"	Screw-On	300
GTEC2198A-15	1-5/16"	Dowelled	300
GTEC2176A-15	1-5/16"	Screw-On	300
GTEC2782-15	1-3/8"	Dowelled	300
GTEC4548-15	1-3/8"	Screw-On	300
GTEC2805-15	1-1/2"	Dowelled	300
GTEC4549-15	1-1/2"	Screw-On	300

Wrap-Around 42mm Boring Pattern

Item #	Overlay	Fixing Type	Box Qty
GTEC2836-15	1-1/4"	Dowelled	300
GTEC2839-15	1-1/2"	Dowelled	300



Angle Restriction Clip

- Reduces opening angle from 108° to 85°

Item #	Box Qty
G80125-42	100

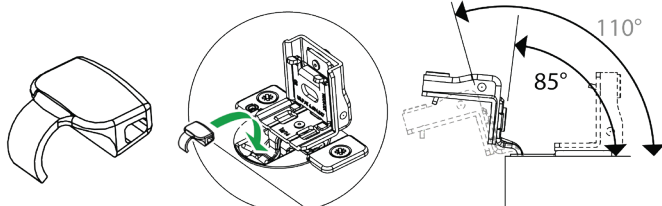

GRASS TEC 863 SOFT-CLOSE & SELF-CLOSE FACE MOUNT HINGES



**108° Opening Angle - For Overlays
1-7/16" and Greater**

- Available in Soft-close and Self-close
- Soft-close damper is pre-mounted in the hinge cup
- Adjustment switch on Soft-close to regulate closing action
- One piece hinge and baseplate combination
- 2 dimensional adjustment
- 1 1/8" (7/16") cup drilling depth
- Height adjustment at mounting screw
- Made in the USA

Face-Mount 45mm Boring Pattern Soft-Close			
Item #	Overlay	Fixing Type	Box Qty
GTEC2294A-15	1-7/16+	Dowelled	300
GTEC2295A-15	1-7/16+	Screw-On	300

Face-Mount 45mm Boring Pattern Self-Close			
Item #	Overlay	Fixing Type	Box Qty
GTEC2283-15	1-7/16+	Dowelled	300
GTEC2284-15	1-7/16+	Screw-On	300

Face-Mount 42mm Boring Pattern Self-Close			
Item #	Overlay	Fixing Type	Box Qty
GTEC02282-15	1-7/16+	Dowelled	300



Angle Restriction Clip

- Reduces opening angle from 108° to 85°

Item #	Box Qty
G80125-42	100

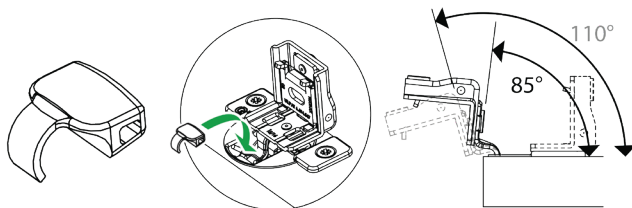

A
B
C
D
E
F
G
H
I
J
K
L
M
N
O
P
Q
R
S
T
U
V
W
X
Y

A GRASS TEC 864 SELF-CLOSE HINGES



108° Opening Angle - 1/4" to 1" Overlay



- One piece hinge and baseplate combination
- 3 dimensional adjustment
- 11mm (7/16") cup drilling depth
- Front locating tabs position hinge on face frame
- Cam side adjustment
- Cam depth adjustment
- Height adjustment at mounting screw
- Works with current GRASS insertion machinery
- Made in the USA

Side-Mount - 45mm Boring Pattern			
Item #	Overlay	Fixing Type	Box Qty
GTEC864VS8-45-1/4	1/4"	Dowelled	300
GTEC4386-15	1/4"	Screw-On	300
GTEC864VS8-45	1/2"	Dowelled	300
GTEC4387-15	1/2"	Screw-On	300
GTEC864VS8-0745	5/8"	Dowelled	300
GTEC2878-15	3/4"	Dowelled	300
GTEC4390-15	3/4"	Screw-On	300
GTEC864VS8-45-1	1"	Dowelled	300
GTEC4395-15	1"	Screw-On	300

Side-Mount - 42mm Boring Pattern			
Item #	Overlay	Fixing Type	Box Qty
GTEC864VS8-1/2	1/2"	Dowelled	300
GTEC864VS8-1	1"	Dowelled	300

Wrap-Around 45mm Boring Pattern			
Item #	Overlay	Fixing Type	Box Qty
GTEC02847-15	1/4"	Dowelled	300
GTEC4396-15	1/4"	Screw-On	300
GTEC02904-15	7/16"	Dowelled	300
GTEC864VS8-45-1/2	1/2"	Dowelled	300
GTEC4399-15	1/2"	Screw-On	300
GTEC864VS8-45U-3/4	3/4"	Dowelled	300
GTEC4400-15	3/4"	Screw-On	300
GTEC02882-15	1"	Dowelled	300
GTEC4401-15	1"	Screw-On	300

Wrap-Around 42mm Boring Pattern			
Item #	Overlay	Fixing Type	Box Qty
GTEC02846-15	1/4"	Dowelled	300
GTEC02869-15	1/2"	Dowelled	300
GTEC02873-15	3/4"	Dowelled	300
GTEC02879-15	1"	Dowelled	300

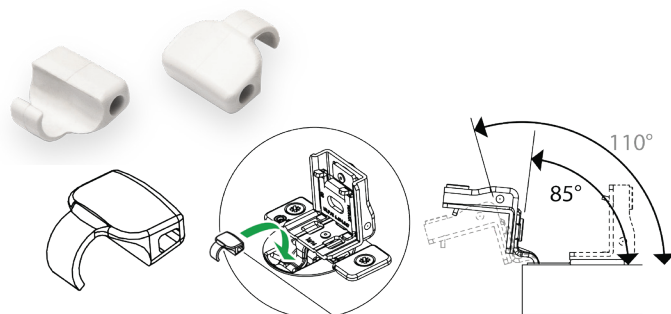

Angle Restriction Clip

- Reduces opening angle from 108° to 85°

Item #	Box Qty
G80125-42	100

GRASS TEC 864 SELF-CLOSE HINGES



108° Opening Angle - 1-1/4" to 1-1/2" Overlay

- One piece hinge and baseplate combination
- 3 dimensional adjustment
- 11mm (7/16") cup drilling depth
- Front locating tabs position hinge on face frame
- Cam side adjustment
- Cam depth adjustment
- Height adjustment at mounting screw
- Works with current GRASS insertion machinery
- Made in the USA

Side-Mount - 45mm Boring Pattern			
Item #	Overlay	Fixing Type	Box Qty
GTEC864VS8-45-1-14	1-1/4"	Dowelled	300
GTEC4466-15	1-1/4"	Screw-On	300
GTEC2898-15	1-3/8"	Dowelled	300
GTEC4468-15	1-3/8"	Screw-On	300
GTEC2903-15	1-1/2"	Dowelled	300
GTEC4469-15	1-1/2"	Screw-On	300

Side-Mount - 42mm Boring Pattern			
Item #	Overlay	Fixing Type	Box Qty
GTEC864VS8-1-1/4	1-1/4"	Dowelled	300
GTEC2897-15	1-3/8"	Dowelled	300
GTEC2902-15	1-1/2"	Dowelled	300

Wrap-Around 45mm Boring Pattern			
Item #	Overlay	Fixing Type	Box Qty
G02933	1-1/4"	Dowelled	300
GTEC4493-15	1-1/4"	Screw-On	300
GTEC02896-15	1-3/8"	Dowelled	300
GTEC4498-15	1-3/8"	Screw-On	300
GTEC2901-15	1-1/2"	Dowelled	300
GTEC4499-15	1-1/2"	Screw-On	300

Wrap-Around 42mm Boring Pattern			
Item #	Overlay	Fixing Type	Box Qty
GTEC02886-15	1-1/4"	Dowelled	300

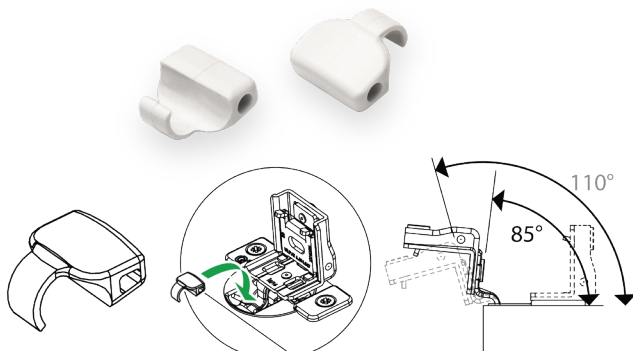

Angle Restriction Clip

- Reduces opening angle from 108° to 85°

Item #	Box Qty
G80125-42	100

A
B
C
D
E
F
G
H
I
J
K
L
M
N
O
P
Q
R
S
T
U
V
W
X
Y

A GRASS TEC 861 SELF-CLOSE HINGES

B
C
D
E
F
G
H
I
J
K
L
M
N
O
P
Q
R
S
T
U
V
W
X
Y



108° Opening Angle

- One piece hinge and baseplate combination
- 11mm (7/16") cup drilling depth
- Front locating tabs position hinge on face frame
- Works on door thicknesses from 13mm (1/2") to 19mm (3/4")
- Works with current GRASS machinery
- 85° angle reduction clip available
- Made in the USA



Side-Mount - 42mm Boring Pattern			
Item #	Overlay	Fixing Type	Box Qty
G04616-16	7/16"	Dowelled	400

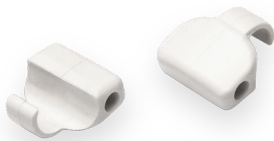

Angle Restriction Clip

- Reduces opening angle from 108° to 85°

Item #	Box Qty
G80125-42	100

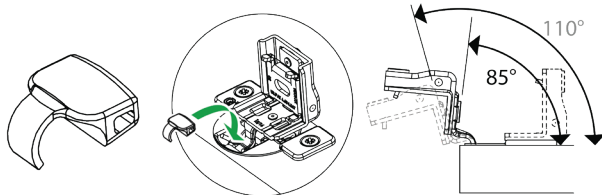

Side Adjustment Spacer

- 1.5mm (1/16") Slotted Spacer

Item #	Box Qty
G0047-42	100

GRASS TEC 861 SELF-CLOSE HINGES FOR MDF FRAME MATERIAL



108° Opening Angle

- Patented wrap-around baseplate prevents splitting of frame material
- One piece hinge and baseplate combination
- 11mm (7/16") cup drilling depth
- Front locating tabs position hinge on face frame
- Works on door thicknesses from 13mm (1/2") to 19mm (3/4")
- Works with current GRASS machinery
- 85° angle reduction clip available
- Made in the USA

Wrap-Around 42mm Boring Pattern

Item #	Frame Thickness	Overlay	Fixing Type	Box Qty
GTEC4742-14	1/2"	1/2"	Dowelled	250
GTEC4743-14	5/8"	1/2"	Dowelled	250



Spacers and Screws

Item #	Description	Box Qty
G00209-42	1.5mm (1/16") Slotted Spacer for MDF 861, Clear	100



Angle Restriction Clip

- Reduces opening angle from 108° to 85°

Item #	Box Qty
G80125-42	100

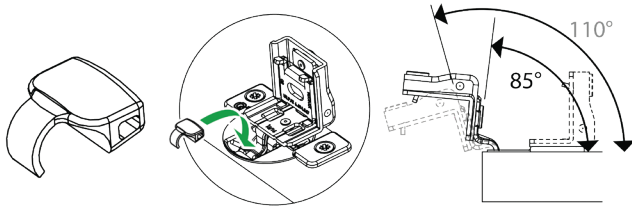

A
B
C
D
E
F
G
H
I
J
K
L
M
N
O
P
Q
R
S
T
U
V
W
X
Y

A GRASS TEC 872 SELF-CLOSE HINGES & SOFT-CLOSE ADAPTERS

B
C
D
E
F
G
H
I
J
K
L
M
N
O
P
Q
R
S
T
U
V
W
X
Y



110° Opening Angle

- 1/2" overlay achievable on profile door
- 3-dimensional hinge
- All metal construction, nickel finish
- Height adjustment in elongated screw hole
- Minimal gap between the door and frame
- Minimal protrusion into cabinet
- Hinge and plate must be ordered separately



Hinges			
Item #	Boring Pattern	Fixing Type	Box Qty
GTEC872VS8-45	45mm	Dowelled	500
GTEC872VS-45	45mm	Screw-On	500

Side-Mount Baseplates		
Item #	Plate Height	Box Qty
GTEC43731	4mm	500



**Universal Face Frame Cabinet Soft-Close
Grass Unisoft Adjustable Soft-Close**



- Grass Unisoft cabinet soft close device is unhandled and mounts independently of door hinge
- The unit is designed to mount with a single screw to the upper corner of the cabinet opening
- Unisoft is constructed of high grade plastic and has a sleek brushed nickel finish housing
- The Unisoft soft-closing speed/tension can be easily adjusted by the hand turn of a rear screw
- Unisoft can be used on a wide variety of door sizes weights, including face frame applications
- Scratch protector and front bumper with cushion for a quiet close

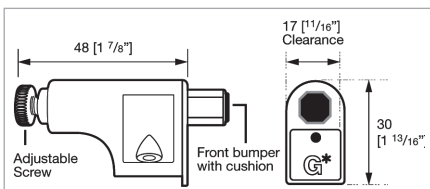
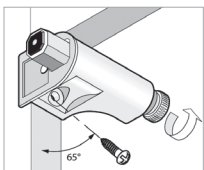

Item #	Box Qty
GUNISOFT-P	1 each per poly bag
G18971-40	25 per box
GUNISOFT-B	250 per box



Accessory Items	
Item #	Description
AN608520	Vix Bit, 1/4" Hex Shank, #6 Screw
AN630520	Replacement Bit for above

GRASS HINGE MACHINES & ACCESSORIES

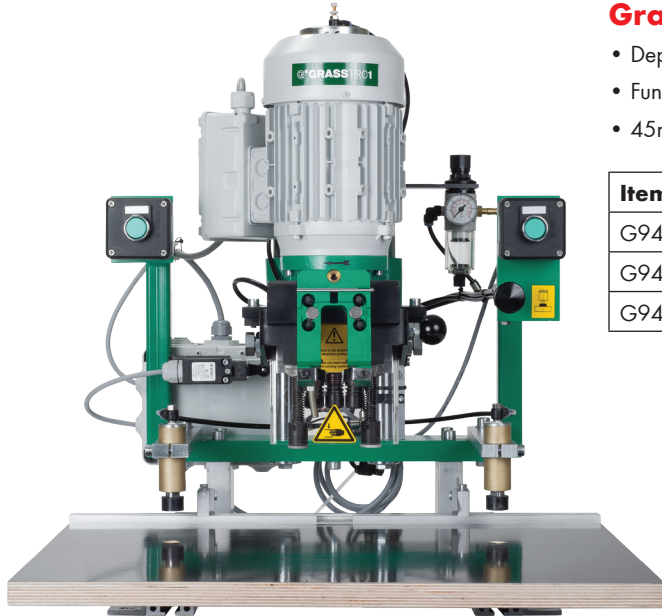

Grass PRO1 for Hinge Drilling



- Depth stop can be adjusted to material thickness
- Functional design with fast and efficient operation
- 45mm boring pattern

Item #	Description
G94559-01	220V Single Phase Pneumatic Machine
G94560-01	220V Three Phase Pneumatic Machine
G94561-01	110V Single Phase Pneumatic Machine

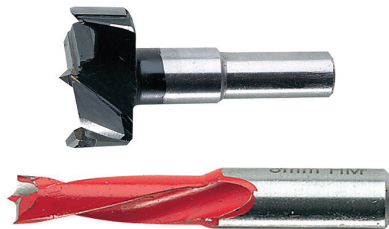

American Bit Set for Hinge Drilling



- Set consists of (1) 35mm bit, RH and (2) 8mm bits, LH

Item #
G00213-01

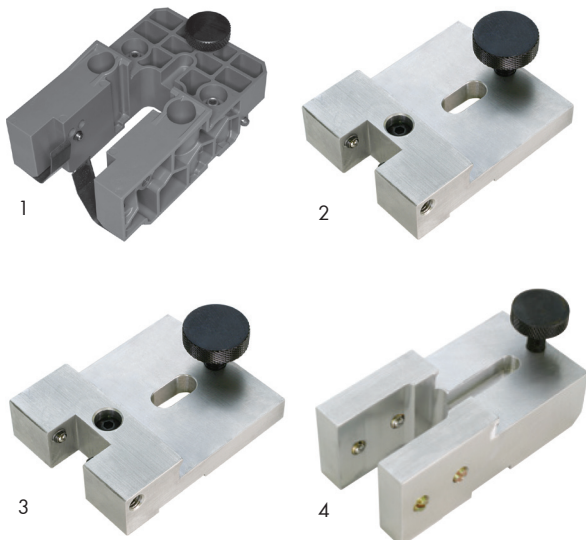

Insertion Dies		
Item #	Description	
1	G80039 Universal Die for Tiomos 110°/120°/160° Hinges	
2	G92617 TEC Die for All Cup Styles	
3	G04216 Insertion Die for Nexis 110°/125° Hinges	
4	G04218 Insertion Die for Nexis 170° Hinges	

A
B
C
D
E
F
G
H
I
J
K
L
M
N
O
P
Q
R
S
T
U
V
W
X
Y

A GRASS HINGE ACCESSORIES & ASSEMBLY HARDWARE

B
C
D
E
F
G
H
I
J
K
L
M
N
O
P
Q
R
S
T
U
V
W
X
Y



Cover Caps

- Hole covers for 35mm cup drillings



White Item #	Box Qty
G22227-42	100



Euro Screws, Nickel-Plated

Item #	Description	Box Qty
G81015	13mm Euro Screw (1/2")	500
A G83000	18mm Euro Screw (1 1/16")	500
G83001-43	7.5mm Euro Screw (5/16")	500
B G499.360.61.1015	Euro Screw 11mm (7/16") Pozi	500



Wood Screws, Nickel-Plated

Item #	Description	Box Qty
G81014-43	#6 x 1/2" FHP Wood Screw	500
G81001-43	#6 x 5/8" FHP Wood Screw	500
G6X34FHNI	#6 x 3/4" FHP Wood Screw	500
G81007-43	#10 x 3/4" Pan Head, Nickel	500



Plastic Dowels

Item #	Description	Box Qty
G00102-43	8mm Dowel for TEC Hinges	500
GTEC2445-43	Spax screw for TEC Hinge Dowel	500
GF072135773247	8mm Dowel for Tiomos Hinges	500
G04885-43	8mm Dowel for VZ Hinge Cup	1,000
G05404-43	10mm Dowel for Baseplates	500



Pozidrive Screwdriver

Item #	Description	Box Qty
GPD	#2 Pozidrive Screwdriver for Hinges	1



Angle Restriction Clip for TEC Hinges

- Reduces opening angle from 108° to 85°

Item #	Box Qty
G80125-42	100

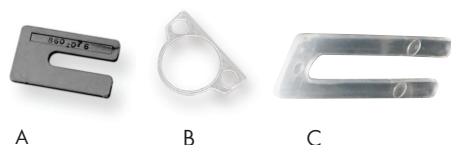

Spacers

Item #	Description	Box Qty
A G0047-42	860-076 1.5mm (1/16") Thick, Slotted	100
B G00284	1.5mm (1/16") Thick, Hinge Cup Spacer	100
C G00209-42	1.5mm (1/16") Thick, Slotted for MDF, Clear	100

HETTICH SENSYS EURO HINGES W/SOFT-CLOSE



**Sensys 110° Hinges w/Soft-Close
8645i Series**



- For door thickness 15 - 24 mm, Cup depth 12.8 mm
- Integrated overlay adjustment +2 mm / -2 mm
- Integrated depth adjustment +3 mm / -2 mm
- Height adjustment at mounting plate
- Quality classification under EN 15570, Level 3

Item #	Opening	Overlay	Fixing	Close Type	Box Qty
HET9071223	110°	Full	Screw-On	Soft-close	200
HET9071226	110°	Full	Dowel	Soft-close	200
HET9073626	110°	Full	Fix Fast	Soft-close	50
HET9073689	110°	Full	Exp Dowel	Soft-close	50
HET9073618	110°	Half	Screw-On	Soft-close	50
HET9073621	110°	Half	Dowel	Soft-close	50
HET9073627	110°	Half	Fix Fast	Soft-close	50
HET9073690	110°	Half	Exp Dowel	Soft-close	50
HET9073619	110°	Inset	Screw-On	Soft-close	50
HET9073622	110°	Inset	Dowel	Soft-close	50
HET9073628	110°	Inset	Fix Fast	Soft-close	50
HET9073691	110°	Inset	Exp Dowel	Soft-close	50

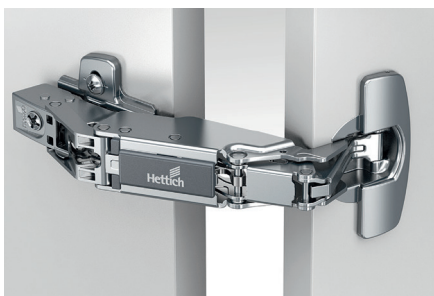

**Sensys 165° Hinges w/Soft-Close
8657i Series**



- Sensys wide angle hinge, with zero protrusion
- For door thickness 15 - 32 mm, Cup depth 11.6 mm
- Integrated overlay adjustment +2 mm / -2 mm
- Integrated depth adjustment +3 mm / -2 mm
- Height adjustment at mounting plate
- Quality classification under EN 15570, Level 3

Item #	Opening	Overlay	Fixing	Close Type	Box Qty
HET9099560	165°	Full	Screw-On	Soft-close	50
HET9099561	165°	Full	Dowel	Soft-close	50
HET9099563	165°	Full	Fix Fast	Soft-close	50
HET9099566	165°	Full	Exp Dowel	Soft-close	50
HET9099570	165°	Half	Screw-On	Soft-close	50
HET9099571	165°	Half	Dowel	Soft-close	50
HET9099573	165°	Half	Fix Fast	Soft-close	50
HET9099576	165°	Half	Exp Dowel	Soft-close	50

A
B
C
D
E
F
G
H
I
J
K
L
M
N
O
P
Q
R
S
T
U
V
W
X
Y

A HETTICH SENSYS EURO HINGES W/SOFT-CLOSE

B
C
D
E
F
G
H
I
J
K
L
M
N
O
P
Q
R
S
T
U
V
W
X
Y



**Sensys 95° Hinges w/Soft-Close
8631i Series**



- For door thickness 15 - 32 mm
- Cup depth 12.8 mm
- Integrated overlay adjustment +2 mm / -2 mm
- Integrated depth adjustment +3 mm / -2 mm
- Height adjustment at mounting plate
- Quality classification under EN 15570, Level

Item #	Opening	Overlay	Fixing	Close Type	Box Qty
HET9091430	95°	Full	Screw-On	Soft-close	50
HET9091431	95°	Full	Dowel	Soft-close	50
HET9091436	95°	Full	Exp Dowel	Soft-close	50
HET9091440	95°	Half	Screw-On	Soft-close	50
HET9091441	95°	Half	Dowel	Soft-close	50
HET9091446	95°	Half	Exp Dowel	Soft-close	50
HET9091450	95°	Inset	Screw-On	Soft-close	50
HET9091451	95°	Inset	Dowel	Soft-close	50
HET9091456	95°	Inset	Exp Dowel	Soft-close	50



**Sensys 110° Hinges w/Soft-Close (Thin Door)
8646i Series**



- SENSYS thin door hinge, door thickness from 10 mm
- For door thickness 10 - 19 mm
- Cup depth 7.8 mm
- Integrated overlay adjustment +2 mm / -2 mm
- Integrated depth adjustment +3 mm / -2 mm
- Height adjustment at mounting plate
- Quality classification under EN 15570, Level 3

Item #	Opening	Overlay	Fixing	Close Type	Box Qty
HET9094300	110°	Full	Screw-On	Soft-close	50
HET9094301	110°	Full	Dowel	Soft-close	50
HET9094306	110°	Full	Exp Dowel	Soft-close	50
HET9094310	110°	Half	Screw-On	Soft-close	50
HET9094311	110°	Half	Dowel	Soft-close	50
HET9094316	110°	Half	Exp Dowel	Soft-close	50
HET9094320	110°	Inset	Screw-On	Soft-close	50
HET9094321	110°	Inset	Dowel	Soft-close	50
HET9094326	110°	Inset	Exp Dowel	Soft-close	50

HETTICH SENSYS EURO HINGES W/SOFT-CLOSE



Sensys 95° Hinges w/Soft-Close
For 45° Face Angle, 8639i W45 Series



- For door thickness 15 - 28 mm
- Cup depth 12.8 mm
- Integrated overlay adjustment +2 mm / -2 mm
- Integrated depth adjustment +3 mm / -2 mm
- Height adjustment at mounting plate
- Quality classification under EN 15570, Level 3

Item #	Opening	Overlay	Fixing	Close Type	Box Qty
HET9088024	95°	Overlay Base B 9mm	Screw-On	Soft-close	50
HET9088042	95°	Overlay Base B 9mm	Dowel	Soft-close	50
HET9088078	95°	Overlay Base B 9mm	Fix Fast	Soft-close	50
HET9088025	95°	Inset Base B -2mm	Screw-On	Soft-close	50
HET9088043	95°	Inset Base B -2mm	Dowel	Soft-close	50
HET9088079	95°	Inset Base B -2mm	Fix Fast	Soft-close	50
HET9088026	95°	Inset Base B -25mm	Screw-On	Soft-close	50



Sensys 95° Hinges w/Soft-Close
For 90° Face Angle, 8639i W90 Series



- For door thickness 15 - 28 mm
- Cup depth 12.8 mm
- Integrated adjustment of door offset +1 mm / -2 mm
- Integrated reveal adjustment +3 mm / -2 mm
- Height adjustment at mounting plate
- Quality classification under EN 15570, Level 3

Item #	Opening	Overlay	Fixing	Close Type	Box Qty
HET9088027	95°	Inset	Screw-On	Soft-close	50
HET9088045	95°	Inset	Dowel	Soft-close	50
HET9088081	95°	Inset	Fix Fast	Soft-close	50
HET9088093	95°	Inset	Exp Dowel	Soft-close	50

A
B
C
D
E
F
G
H
I
J
K
L
M
N
O
P
Q
R
S
T
U
V
W
X
Y

A HETTICH SENSYS SELF-CLOSE EURO HINGES

B
C
D
E
F
G
H
I
J
K
L
M
N
O
P
Q
R
S
T
U
V
W
X
Y



**Sensys 110° Self-Close Hinges
8645 Series**



- For door thickness 15 - 24 mm
- Cup depth 12.8 mm
- Integrated overlay adjustment +2 mm / -2 mm
- Integrated depth adjustment +3 mm / -2 mm
- Height adjustment at mounting plate
- Quality classification under EN 15570, Level 3

Item #	Opening	Overlay	Fixing	Close Type	Box Qty
HET9073647	110°	Full	Screw-On	Self-close	50
HET9073650	110°	Full	Dowel	Self-close	50
HET9073653	110°	Full	Fix Fast	Self-close	50
HET9073648	110°	Half	Screw-On	Self-close	50
HET9073651	110°	Half	Dowel	Self-close	50
HET9073654	110°	Half	Fix Fast	Self-close	50
HET9073649	110°	Inset	Screw-On	Self-close	50
HET9073652	110°	Inset	Dowel	Self-close	50
HET9073655	110°	Inset	Fix Fast	Self-close	50

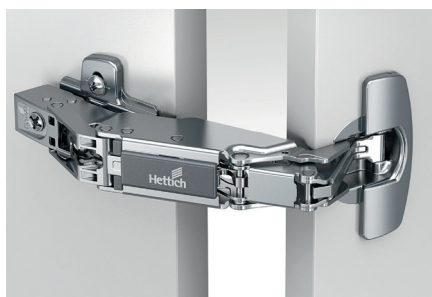

**Sensys 165° Self-Close Hinges
8657 Series**



- Sensys wide angle hinge, with zero protrusion
- For door thickness 15 - 32 mm
- Cup depth 11.6 mm
- Integrated overlay adjustment +2 mm / -2 mm
- Integrated depth adjustment +3 mm / -2 mm
- Height adjustment at mounting plate
- Quality classification under EN 15570, Level 3

Item #	Opening	Overlay	Fixing	Close Type	Box Qty
HET9099770	165°	Full	Screw-On	Self-close	50
HET9099771	165°	Full	Dowel	Self-close	50
HET9099773	165°	Full	Fix Fast	Self-close	50
HET9099776	165°	Full	Exp Dowel	Self-close	50
HET9099780	165°	Half	Screw-On	Self-close	50
HET9099781	165°	Half	Dowel	Self-close	50
HET9099783	165°	Half	Fix Fast	Self-close	50
HET9099786	165°	Half	Exp Dowel	Self-close	50

HETTICH SENSYS SELF-CLOSE EURO HINGES

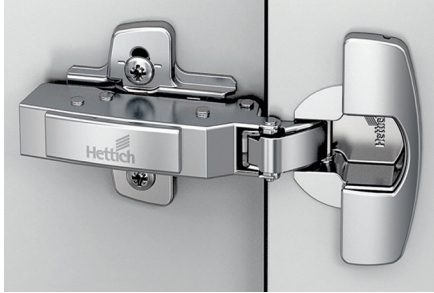

Sensys 95° Self-Close Hinges 8631 Series



- For door thickness 15 - 32 mm
- Cup depth 12.8 mm
- Integrated overlay adjustment +2 mm / -2 mm
- Integrated depth adjustment +3 mm / -2 mm
- Height adjustment at mounting plate
- Quality classification under EN 15570, Level 2

Item #	Opening	Overlay	Fixing	Close Type	Box Qty
HET9091520	95°	Full	Screw-On	Self-close	50
HET9091521	95°	Full	Dowel	Self-close	50
HET9091530	95°	Half	Screw-On	Self-close	50
HET9091531	95°	Half	Dowel	Self-close	50
HET9091540	95°	Inset	Screw-On	Self-close	50
HET9091541	95°	Inset	Dowel	Self-close	50

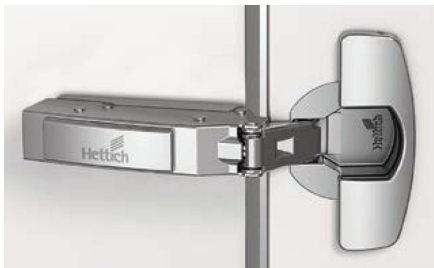

Sensys 110° Self-Close Hinges (Thin Door) 8646 Series



- Sensys thin door hinge, door thickness from 10 mm
- For door thickness 10 - 19 mm
- Cup depth 7.8 mm
- Integrated overlay adjustment +2 mm / -2 mm
- Integrated depth adjustment +3 mm / -2 mm
- Height adjustment at mounting plate
- Quality classification under EN 15570, Level 3

Item #	Opening	Overlay	Fixing	Close Type	Box Qty
HET9094390	110°	Full	Screw-On	Self-close	50
HET9094391	110°	Full	Dowel	Self-close	50
HET9094396	110°	Full	Exp Dowel	Self-close	50
HET9094400	110°	Half	Screw-On	Self-close	50
HET9094401	110°	Half	Dowel	Self-close	50
HET9094406	110°	Half	Exp Dowel	Self-close	50
HET9094410	110°	Inset	Screw-On	Self-close	50
HET9094411	110°	Inset	Dowel	Self-close	50
HET9094416	110°	Inset	Exp Dowel	Self-close	50

A
B
C
D
E
F
G
H
I
J
K
L
M
N
O
P
Q
R
S
T
U
V
W
X
Y

A HETTICH INTERMAT SELF-CLOSE EURO HINGES

**Intermat 110° Self-Close Hinges
9943 Series**

- For door thickness 15 - 25 mm
- Cup diameter 35 mm
- Cup depth 11.6 mm
- Integrated overlay adjustment + 2 mm / - 2 mm
- Integrated depth adjustment + 2.5 mm / - 1.5 mm
- Height adjustment at mounting plate
- Quality classification under EN 15570, Level 3

Item #	Opening	Overlay	Fixing	Close Type	Box Qty
HET1073711	110°	Full	Screw-On	Self-close	200
HET1029522	110°	Full	Dowel	Self-close	200
HET9043643	110°	Full	Exp Dowel	Self-close	200
HET9046806	110°	Half	Screw-On	Self-close	200
HET1030921	110°	Half	Dowel	Self-close	200
HET9046807	110°	Inset	Screw-On	Self-close	200
HET1030925	110°	Inset	Dowel	Self-close	200
HET9043645	110°	Inset	Exp Dowel	Self-close	200



**Intermat 95° Self-Close Hinges
9936 Series**

- For door thickness 14 - 32 mm
- Cup diameter 35 mm
- Cup depth 11.1 mm
- Integrated overlay adjustment + 2 mm / - 2 mm
- Integrated depth adjustment + 2.5 mm / - 1.5 mm
- Height adjustment at mounting plate
- Quality classification under EN 15570, Level 2

Item #	Opening	Overlay	Fixing	Close Type	Box Qty
HET9015624	95°	Full	Screw-On	Self-close	200
HET1058445	95°	Full	Dowel	Self-close	200
HET9043632	95°	Full	Exp Dowel	Self-close	200
HET9046810	95°	Half	Screw-On	Self-close	200
HET1058446	95°	Half	Dowel	Self-close	200
HET9043633	95°	Half	Exp Dowel	Self-close	200
HET9046811	95°	Inset	Screw-On	Self-close	200
HET1058447	95°	Inset	Dowel	Self-close	200
HET9043634	95°	Inset	Exp Dowel	Self-close	200

HETTICH INTERMAT EURO HINGES

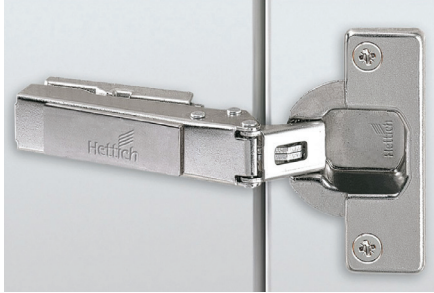
A
B
C
D
E
F
G
H
I
J
K
L
M
N
O
P
Q
R
S
T
U
V
W
X
Y



Intermat 125° Self-Close Hinges 9944 Series

- For door thickness 15 - 28 mm / Cup diameter 35 mm / Cup depth 12.7 mm
- Integrated overlay adjustment + 2 mm / - 2 mm
- Integrated depth adjustment + 2.5 mm / - 1.5 mm
- Height adjustment at mounting plate



Item #	Opening	Overlay	Fixing	Close Type	Box Qty
HET1070715	125°	Full	Screw-On	Self-close	200
HET1058549	125°	Full	Dowel	Self-close	200
HET9044970	125°	Full	Exp Dowel	Self-close	200
HET9046809	125°	Half	Screw-On	Self-close	200
HET1058550	125°	Half	Dowel	Self-close	200
HET9044971	125°	Half	Exp Dowel	Self-close	200



Intermat 95° Self-Close Hinges

For 90° Face Angle, 9936 W90 Series

- For door thickness 14 - 28 mm / Cup diameter 35 mm / Cup depth 11.1 mm
- Integrated adjustment of door offset + 2 mm / - 2 mm
- Integrated reveal adjustment + 2 mm / - 2 mm
- Height adjustment at mounting plate



Item #	Opening	Overlay	Fixing	Close Type	Box Qty
HET9043751	95°	Overlay Base B 22mm	Screw-On	Self-close	50
HET9043753	95°	Overlay Base B 22mm	Dowel	Self-close	50
HET9043757	95°	Overlay Base B 22mm	Exp Dowel	Self-close	50
HET9043750	95°	Inset Base B 5mm	Screw-On	Self-close	50
HET9043497	95°	Inset Base B 5mm	Dowel	Self-close	50
HET9043682	95°	Inset Base B 5mm	Exp Dowel	Self-close	50



Intermat 50°/65° Hinges (Spring Loaded)

9930 Series

- For door thickness 15 - 21 mm / Cup depth 12.8 mm
- Diagonal adjustment +9.5 mm / -9.5 mm
- Height adjustment at mounting plate



Item #	Opening	Overlay	Fixing	Close Type	Box Qty
HET9090115	50°/65°	Overlay	Screw-On	Spring Loaded	50
HET9090116	50°/65°	Overlay	Dowel	Spring Loaded	50
HET9090119	50°/65°	Overlay	Fix Fast	Spring Loaded	50
HET9090108	50°/65°	Overlay	Exp Dowel	Spring Loaded	50



A HETTICH SENSYS & INTERMAT MOUNTING PLATES

B
C
D
E
F
G
H
I
J
K
L
M
N
O
P
Q
R
S
T
U
V
W
X
Y



Cross Mounting Plates, Screw-On				
Item #	Height	Fixing Type	Oblong Hole Ht Adj	Box Qty
HET9071575	0mm	For Wood Screws	+/-3mm	200
HET9071576	1.5mm	For Wood Screws	+/-3mm	200
HET9071577	3mm	For Wood Screws	+/-3mm	200
HET9071578	5mm	For Wood Screws	+/-3mm	200



Cross Mounting Plates w/5mm Expanding Dowels & Special Screws				
Item #	Height	Fixing Type	Oblong Hole Ht Adj	Box Qty
HET9071595	0mm	Premounted Screws	+/-2mm	200
HET9071596	1.5mm	Premounted Screws	+/-2mm	200
HET9071597	3mm	Premounted Screws	+/-2mm	200
HET9071598	5mm	Premounted Screws	+/-2mm	200



Cross Mounting Plates w/Premounted Euro Screws				
Item #	Height	Fixing Type	Oblong Hole Ht Adj	Box Qty
HET9071625	0mm	Premounted Euro Screws	+/-3mm	200
HET9071626	1.5mm	Premounted Euro Screws	+/-3mm	200
HET9071627	3mm	Premounted Euro Screws	+/-3mm	200
HET9071628	5mm	Premounted Euro Screws	+/-3mm	200



Patented "Hettich Direkt" Cross Mounting Plates w/Pin & Special Screws				
Item #	Height	Fixing Type	Oblong Hole Ht Adj	Box Qty
HET9071585	0mm	Premounted Screws	+/-2mm	200
HET9071586	1.5mm	Premounted Screws	+/-2mm	200
HET9071587	3mm	Premounted Screws	+/-2mm	200
HET9071588	5mm	Premounted Screws	+/-2mm	200

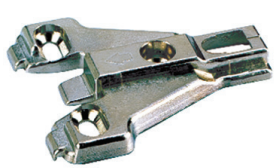

Face Frame Mounting Plates, Screw-On (Sensys Hinges Only)				
Item #	Height	Fixing Type	Oblong Hole Ht Adj	Box Qty
HET9084930	0mm	For Wood Screws	+/-2mm	200
HET9084931	4.5mm	For Wood Screws	+/-2mm	200

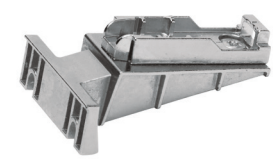

Inset Face Frame Mounting Plate, System 8099 OBLONG HOLE ADJUSTMENT (Sensys Hinges Only)				
Item #	Height	Fixing Type	Oblong Hole Ht Adj	Box Qty
HET1135793	3mm	For Wood Screws	+/-1.6mm	100

HETTICH SENSYS & INTERMAT MOUNTING PLATES



Cross Mounting Plates w/5mm Expanding Dowels & Special Screws				
Item #	Height	Fixing Type	Direct Height Adj	Box Qty
HET9071655	0mm	Premounted Screws	+/-2mm	200
HET9071656	1.5mm	Premounted Screws	+/-2mm	200
HET9071657	3mm	Premounted Screws	+/-2mm	200
HET9071658	5mm	Premounted Screws	+/-2mm	200



Cross Mounting Plate w/Premounted Chipboard Screws - For Holes w/Max. ø 2.5 mm				
Item #	Height	Fixing Type	Direct Height Adj	Box Qty
HET9071670	0mm	Premounted Screws	+/-2mm	200
HET9071671	1.5mm	Premounted Screws	+/-2mm	200
HET9071672	3mm	Premounted Screws	+/-2mm	200
HET9071673	5mm	Premounted Screws	+/-2mm	200



Cross Mounting Plate w/Premounted Euro Screws - For ø 5 x 12 mm Holes				
Item #	Height	Fixing Type	Direct Height Adj	Box Qty
HET9071665	0mm	Premounted Euro Screws	+/-2mm	200
HET9071666	1.5mm	Premounted Euro Screws	+/-2mm	200
HET9071667	3mm	Premounted Euro Screws	+/-2mm	200
HET9071668	5mm	Premounted Euro Screws	+/-2mm	200



Cross mounting plate with premounted Euro screws - For ø 5 x 8 mm Holes				
Item #	Height	Fixing Type	Direct Height Adj	Box Qty
HET9071645	0mm	Premounted Euro Screws	+/-2mm	200
HET9071646	1.5mm	Premounted Euro Screws	+/-2mm	200
HET9071647	3mm	Premounted Euro Screws	+/-2mm	200
HET9071648	5mm	Premounted Euro Screws	+/-2mm	200



Patented "Hettich Direkt" Cross Mounting Plate w/Pin & Special Screws				
Item #	Height	Fixing Type	Direct Height Adj	Box Qty
HET9071650	0mm	Premounted Screws	+/-2mm	200
HET9071651	1.5mm	Premounted Screws	+/-2mm	200
HET9071652	3mm	Premounted Screws	+/-2mm	200
HET9071653	5mm	Premounted Screws	+/-2mm	200



Face frame Mounting Plate, Screw-On				
Item #	Height	Fixing Type	Direct Height Adj	Box Qty
HET9090882	0mm	For Wood Screws	+/-2mm	50
HET9090884	4.5mm	For Wood Screws	+/-2mm	50



Inset Face Frame Mounting Plate, System 8099 CAM HEIGHT ADJUSTMENT				
Item #	Height	Fixing Type	Direct Height Adj	Box Qty
HET9179885	3mm	For Wood Screws	+/-1.6mm	100

A
B
C
D
E
F
G
H
I
J
K
L
M
N
O
P
Q
R
S
T
U
V
W
X
Y

A HETTICH SENSYS ACCESSORIES

B
C
D
E
F
G
H
I
J
K
L
M
N
O
P
Q
R
S
T
U
V
W
X
Y



Cover Cap for Sensys Hinge Arm

- Can be used with all SENSYS hinges apart from Sensys wide angle hinge



Item #	Description	Box Qty
HET9088249	Cover Cap For Sensys Hinge Arm	50



Cover Cap for Sensys Hinge Cup

- For all SENSYS hinges except ones with Fix and premounted wood screws



Item #	Description	Box Qty
HET9088252	Cover Cap For Sensys Hinge Cup	50



Soft Opening for Sensys Wide Angle Hinge

- Can be used with Sensys wide angle hinges with integrated soft-close
- Cannot be combined with opening angle limiter



Item #	Description	Box Qty
HET9100037	Soft Opening For Sensys Wide Angle Hinge, Full Overlay	50
HET9100116	Soft Opening For Sensys Wide Angle Hinge, Half Overlay	50



Opening Angle Limiter for Sensys 110° Hinge

- Limitation from 110° to 85°



Item #	Description	Box Qty
HET9072540	Angle Limiter to 85°, For Sensys 110° Hinges	50



Opening Angle Limiter for Sensys Wide Angle Hinges



Item #	Description	Box Qty
HET9090756	Angle Limiter For Wide Angle Hinges from 165° to 105° or 120°	50
HET9090864	Angle Limiter For Wide Angle Hinges from 165° to 90° or 135°	50

HETTICH OPTIMAT FACE FRAME HINGES W/SOFT-CLOSE

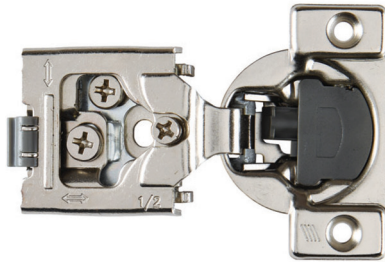

**Optimat 105° Hinges w/Soft-Close
Clip-On Series (2-Piece)**



- 6-way-adjustable face-frame hinge
- For door thickness up to 3/4" (19 mm)
- Cup diameter 1-3/8" (35 mm)
- Cup depth (minimum drilling depth) 7/16" (11 mm), Cup distance 1/8" (3 mm)
- Side adj: (under 1" overlay) +/- 1.3 mm cam & (over 1" overlay) +/- 1.5 mm cam
- Depth adjustment + 2.6 mm cam
- Height adjustment +/- 1.4 mm cam
- Dampening activation: 35°
- Meets and exceeds the minimum requirements of ANSI/BHMA A156.9 standard

Item #	Opening	Overlay	Fixing	Close Type	Box Qty
HET9285007	105°	1/2"	Dowel	Soft-close	200
HET9285006	105°	3/4"	Dowel	Soft-close	200
HET9285008	105°	1-1/4"	Dowel	Soft-close	200



Optimat Angle Reduction Clip To 85°



Item #	Description	Box Qty
HET9299081	85° Angle Reduction Clip for Optimat Clip-On Hinges Only	200

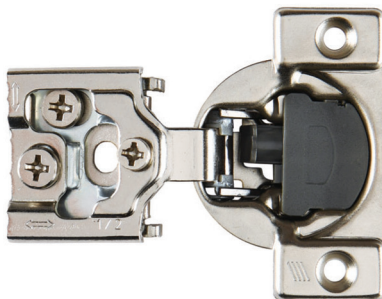

**Optimat 105° Hinges w/Soft-Close
3D Series (1-Piece)**



- 6-way-adjustable face-frame hinge
- For door thickness up to 3/4" (19 mm)
- Cup diameter 1-3/8" (35 mm)
- Cup depth (minimum drilling depth) 7/16" (11 mm), Cup distance 1/8" (3 mm)
- Side adj: (under 1" overlay) +/- 1.3 mm cam & (over 1" overlay) +/- 1.5 mm cam
- Depth adjustment + 2.6 mm cam
- Height adjustment +/- 1.4 mm cam
- Meets and exceeds the minimum requirements of ANSI/BHMA A156.9 standard

Item #	Opening	Overlay	Fixing	Close Type	Box Qty
HET9285000	105°	1/2"	Dowel	Soft-close	200
HET9284998	105°	3/4"	Dowel	Soft-close	200
HET9285010	105°	1"	Dowel	Soft-close	200
HET9285004	105°	1-1/4"	Dowel	Soft-close	200
HET9285002	105°	1-5/16"	Dowel	Soft-close	200

A
B
C
D
E
F
G
H
I
J
K
L
M
N
O
P
Q
R
S
T
U
V
W
X
Y

A HETTICH OPTIMAT SELF-CLOSE FACE FRAME HINGES

B
C
D
E
F
G
H
I
J
K
L
M
N
O
P
Q
R
S
T
U
V
W
X
Y

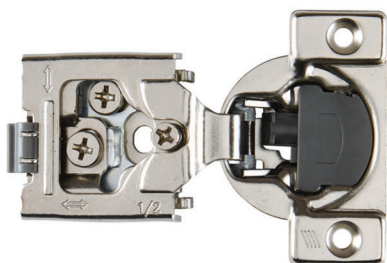

**Optimat 105° Self-Close Hinges
Clip-On Series (2-Piece)**

- 6-way-adjustable face-frame hinge
- For door thickness up to 3/4" (19 mm)
- Cup diameter 1-3/8" (35 mm)
- Cup depth (minimum drilling depth) 7/16" (11 mm)
- Cup distance 1/8" (3 mm)
- Side adj: (under 1" overlay) +/- 1.3 mm cam & (over 1" overlay) +/- 1.5 mm cam
- Depth adjustment + 2.6 mm cam
- Height adjustment +/- 1.4 mm cam
- Meets and exceeds the minimum requirements of ANSI/BHMA A156.9 standard



Item #	Opening	Overlay	Fixing	Close Type	Box Qty
HET9295583	105°	1/2"	Dowel	Self-close	200
HET9295582	105°	3/4"	Dowel	Self-close	200
HET9295584	105°	1-1/4"	Dowel	Self-close	200



OPTIMAT Angle Reduction Clip To 85°

Item #	Description	Box Qty
HET9299081	85° Angle Reduction Clip for OPTIMAT Clip-On Hinges Only	200

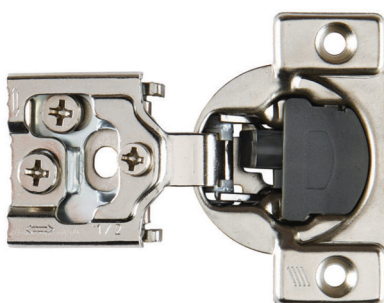

**Optimat 105° Self-Close Hinges
3D Series (1-Piece)**

- 6-way-adjustable face-frame hinge
- For door thickness up to 3/4" (19 mm)
- Cup diameter 1-3/8" (35 mm)
- Cup depth (minimum drilling depth) 7/16" (11 mm)
- Cup distance 1/8" (3 mm)
- Side adj: (under 1" overlay) +/- 1.3 mm cam & (over 1" overlay) +/- 1.5 mm cam
- Depth adjustment + 2.6 mm cam
- Height adjustment +/- 1.4 mm cam
- Meets and exceeds the minimum requirements of ANSI/BHMA A156.9 standard



Item #	Opening	Overlay	Fixing	Close Type	Box Qty
HET9295568	105°	1/2"	Dowel	Self-close	200
HET9295567	105°	3/4"	Dowel	Self-close	200
HET9295585	105°	1"	Dowel	Self-close	200
HET9295570	105°	1-1/4"	Dowel	Self-close	200
HET9295569	105°	1-5/16"	Dowel	Self-close	200

SALICE SILENTIA SOFT-CLOSE 100 SERIES HINGES



**105° Silentia Soft-Close Hinges
100 Series**

SALICE

- 12mm deep cup
- Minimum 15mm/maximum 20mm door thickness
- Side-to-side adjustment from -1.5mm to +4.5mm
- Height adjustment +/-2mm
- Depth adjustment with DOMI snap-on mounting plates from -0.5mm to +2.8mm
- Depth adjustment with 200 Series mounting plates +2.8mm

Item #	Opening	Overlay	Fixing	Close Type	Box Qty
SALC1P6AE9	105°	Full	Screw-On	Soft-close	300
SALC1R6AE9	105°	Full	Dowel	Soft-close	300
SALC176AE9	105°	Full	Rapido	Soft-close	300
SALC1J6AE9	105°	Full	Logica	Soft-close	300
SALC1P6DE9	105°	1/2"	Screw-On	Soft-close	300
SALC1R6DE9	105°	1/2"	Dowel	Soft-close	300
SALC176DE9	105°	1/2"	Rapido	Soft-close	300
SALC1J6DE9	105°	1/2"	Logica	Soft-close	300
SALC1P6GE9	105°	Half	Screw-On	Soft-close	300
SALC1R6GE9	105°	Half	Dowel	Soft-close	300
SALC176GE9	105°	Half	Rapido	Soft-close	300
SALC1J6GE9	105°	Half	Logica	Soft-close	300
SALC1P6PE9	105°	Inset	Screw-On	Soft-close	300
SALC1R6PE9	105°	Inset	Dowel	Soft-close	300
SALC176PE9	105°	Inset	Rapido	Soft-close	300
SALC1J6PE9	105°	Inset	Logica	Soft-close	300



**105° Silentia Soft-Close Inset Blind
Corner Hinges
100 Series**

SALICE

- Inset blind corner hinges for cabinet sides with 37mm x 32mm standard drilling
- 12mm deep cup
- Side-to-side adjustment from -1.5mm to +4.5mm
- Height adjustment +/-2mm
- Depth adjustment with DOMI snap-on mounting plates from -0.5mm to +2.8mm
- Depth adjustment with 200 Series mounting plates +2.8mm

Item #	Opening	Hinge Type	Fixing	Close Type	Box Qty
SALC1P6NE9AC	105°	Inset	Screw-On	Soft-close	150
SALC1R6NE9AC	105°	Inset	Dowel	Soft-close	150
SALC176NE9AC	105°	Inset	Rapido	Soft-close	150

A
B
C
D
E
F
G
H
I
J
K
L
M
N
O
P
Q
R
S
T
U
V
W
X
Y

A SALICE SILENTIA SOFT-CLOSE 100 SERIES HINGES

B
C
D
E
F
G
H
I
J
K
L
M
N
O
P
Q
R
S
T
U
V
W
X
Y



105° Silentia Soft-Close Short Arm Inset Blind Corner Hinges
100 Series

SALICE

- Inset blind corner hinges for smaller spaces with 15mm x 32mm drilling
- 12mm deep cup
- Use only with B2S baseplates

Item #	Opening	Hinge Type	Fixing	Close Type	Box Qty
SALC1R6NE9	105°	Inset	Dowel	Soft-close	150



105° Silentia Soft-Close Angled Hinges
100 Series

SALICE

- For doors with positive angled assembly
- 12mm deep cup
- Side-to-side adjustment from -1.5mm to +4.5mm
- Height adjustment +/-2mm
- Depth adjustment with DOMI snap-on mounting plates from -0.5mm to +2.8mm
- Depth adjustment with 200 Series mounting plates +2.8mm



1

	Item #	Opening	Degree	Fixing	Close Type	Box Qty
1	SALC1R6EE9	105°	+30°	Dowel	Soft-close	150
2	SALC1P6ME9	105°	+45°	Screw-On	Soft-close	150
	SALC1R6ME9	105°	+45°	Dowel	Soft-close	150
3	SALC176ME9	105°	+45°	Rapido	Soft-close	150
	SALC1P6ME9AC	105°	+45° Twin Application	Screw-On	Soft-close	150
	SALC1R6ME9AC	105°	+45° Twin Application	Dowel	Soft-close	150
	SALC176ME9AC	105°	+45° Twin Application	Rapido	Soft-close	150
	SALC1J6ME9AC	105°	+45° Twin Application	Logica	Soft-close	150



2



3

SALICE SILENTIA SOFT-CLOSE 200 SERIES HINGES



**94° Silentia Soft-Close Thick Door Hinges
200 Series**

SALICE

- 15.5mm deep cup
- Minimum 18mm/maximum 35mm door thickness
- Side-to-side adjustment from -1.5mm to +4.5mm
- Height adjustment +/-2mm
- Depth adjustment with DOMI snap-on mounting plates from -0.5mm to +2.8mm
- Depth adjustment with 200 Series mounting plates +2.8mm

Item #	Opening	Overlay	Fixing	Close Type	Box Qty
SALC2PBAE9	94°	Full	Screw-On	Soft-close	300
SALC2RBAE9	94°	Full	Dowel	Soft-close	300
SALC27BAE9	94°	Full	Rapido	Soft-close	300
SALC2JBAE9	94°	Full	Logica	Soft-close	300
SALC2PBDE9	94°	1/2"	Screw-On	Soft-close	300
SALC2RBDE9	94°	1/2"	Dowel	Soft-close	300
SALC27BDE9	94°	1/2"	Rapido	Soft-close	300
SALC2JBDE9	94°	1/2"	Logica	Soft-close	300
SALC2PBGE9	94°	Half	Screw-on	Soft-close	300
SALC2RBGE9	94°	Half	Dowel	Soft-close	300
SALC27BGE9	94°	Half	Rapido	Soft-close	300
SALC2JBGE9	94°	Half	Logica	Soft-close	300
SALC2PBPE9	94°	Inset	Screw-On	Soft-close	300
SALC2RBPE9	94°	Inset	Dowel	Soft-close	300
SALC27BPE9	94°	Inset	Rapido	Soft-close	300



94° Silentia Soft-Close +45° Angled Hinge

SALICE

- For doors with positive angled assembly
- 15.5mm deep cup
- Minimum 18mm thick doors
- Side-to-side adjustment from -1.5mm to +4.5mm
- Height adjustment +/-2mm
- Depth adjustment with DOMI snap-on mounting plates from -0.5mm to +2.8mm
- Depth adjustment with 200 Series mounting plates +2.8mm

Item #	Opening	Degree	Fixing	Close Type	Box Qty
SALC2RBME9	94°	+45°	Dowel	Soft-close	150

A
B
C
D
E
F
G
H
I
J
K
L
M
N
O
P
Q
R
S
T
U
V
W
X
Y

A SALICE SILENTIA SOFT-CLOSE 200 SERIES HINGES

B
C
D
E
F
G
H
I
J
K
L
M
N
O
P
Q
R
S
T
U
V
W
X
Y



**155° Silentia Zero Protrusion Soft-Close Hinges
200 Series**

SALICE

- 13.5mm deep cup
- Minimum 16mm/maximum 28mm door thickness
- Zero protrusion
- Side-to-side adjustment from -1.5mm to +4.5mm
- Height adjustment +/-2mm
- Depth adjustment with DOMI snap-on mounting plates from -0.5mm to +2.8mm
- Depth adjustment with 200 Series mounting plates +2.8mm

Item #	Opening	Overlay	Fixing	Close Type	Box Qty
SALC2PKAE9	155°	Full	Screw-On	Soft-close	100
SALC2RKA9	155°	Full	Dowel	Soft-close	100
SALC27KAE9	155°	Full	Rapido	Soft-close	100
SALC2JKAE9	155°	Full	Logica	Soft-close	100
SALC2PKDE9	155°	1/2"	Screw-On	Soft-close	100
SALC2RKDE9	155°	1/2"	Dowel	Soft-close	100
SALC2PKGE9	155°	Half	Screw-On	Soft-close	100
SALC2RKGE9	155°	Half	Dowel	Soft-close	100
SALC2JKGE9	155°	Half	Logica	Soft-close	100
SALC2PKPE9	155°	Inset	Screw-On	Soft-close	100
SALC2RKPE9	155°	Inset	Dowel	Soft-close	100
SALC2JKPE9	155°	Inset	Logica	Soft-close	100



94° Silentia Soft-Close Inset Blind Corner Hinges

SALICE

- Inset blind corner hinges for cabinet sides with 37mm x 32mm standard drilling
- 15.5mm deep cup
- Minimum 18mm thick doors
- Side-to-side adjustment from -1.5mm to +4.5mm
- Height adjustment +/-2mm
- Depth adjustment with DOMI snap-on mounting plates from -0.5mm to +2.8mm
- Depth adjustment with 200 Series mounting plates +2.8mm

Item #	Opening	Hinge Type	Fixing	Close Type	Box Qty
SALC2PBNE9AC	94°	Inset	Screw-On	Soft-close	150
SALC2RBNE9AC	94°	Inset	Dowel	Soft-close	150

SALICE SILENTIA SOFT-CLOSE 700 SERIES HINGES



110° Silentia Soft-Close Hinges 700 Series

SALICE

- 13.5mm deep cup
- Minimum 16mm/maximum 26mm door thickness
- Side-to-side adjustment from -1.5mm to +4.5mm
- Height adjustment +/-2mm
- Depth adjustment with DOMI snap-on mounting plates from -0.5mm to +2.8mm
- Depth adjustment with 200 Series mounting plates +2.8mm

Item #	Opening	Overlay	Fixing	Close Type	Box Qty
SALC7P6AE9	110°	Full	Screw-On	Soft-close	300
SALC7R6AE9	110°	Full	Dowel	Soft-close	300
SALC776AE9	110°	Full	Rapido	Soft-close	300
SALC7J6AE9	110°	Full	Logica	Soft-close	300
SALC7P6DE9	110°	1/2"	Screw-On	Soft-close	300
SALC7R6DE9	110°	1/2"	Dowel	Soft-close	300
SALC776DE9	110°	1/2"	Rapido	Soft-close	300
SALC7J6DE9	110°	1/2"	Logica	Soft-close	300
SALC7P6GE9	110°	Half	Screw-On	Soft-close	300
SALC7R6GE9	110°	Half	Dowel	Soft-close	300
SALC776GE9	110°	Half	Rapido	Soft-close	300
SALC7J6GE9	110°	Half	Logica	Soft-close	300
SALC7P6PE9	110°	Inset	Screw-On	Soft-close	300
SALC7R6PE9	110°	Inset	Dowel	Soft-close	300
SALC776PE9	110°	Inset	Rapido	Soft-close	300
SALC7J6PE9	110°	Inset	Logica	Soft-close	300

A
B
C
D
E
F
G
H
I
J
K
L
M
N
O
P
Q
R
S
T
U
V
W
X
Y

A SALICE SILENTIA SOFT-CLOSE 700 SERIES HINGES

B
C
D
E
F
G
H
I
J
K
L
M
N
O
P
Q
R
S
T
U
V
W
X
Y

SALICE

110° Silentia Soft-Close Angled Hinges

- 13.5mm deep cup
- Minimum 16mm thick doors
- Side-to-side adjustment from -1.5mm to +4.5mm
- Height adjustment +/-2mm
- Depth adjustment with DOMI snap-on mounting plates from -0.5mm to +2.8mm
- Depth adjustment with 200 Series mounting plates +2.8mm



	Item #	Opening	Degree	Fixing	Close Type	Box Qty
1	SALC7R6UE9	110°	+24°	Dowel	Soft-close	150
2	SALC7R6EE9	110°	+30°	Dowel	Soft-close	150
3	SALC7R6ME9	110°	+45° Corner Merge	Dowel	Soft-close	150
4	SALC7R6VE9	110°	+45° Maximum Overlay	Dowel	Soft-close	150
5	SALC7R6ME9AC	110°	+45° Twin Application	Dowel	Soft-close	150
6	SALC7P6WE9	110°	-30°	Screw-on	Soft-close	150
	SALC7R6WE9	110°	-30°	Dowel	Soft-close	150

110° Silentia Soft-Close Blind Corner Hinges

SALICE

- 13.5mm deep cup
- Minimum 16mm thick doors
- Side-to-side adjustment from -1.5mm to +4.5mm
- Height adjustment +/-2mm
- Depth adjustment with DOMI snap-on mounting plates from -0.5mm to +2.8mm
- Depth adjustment with 200 Series mounting plates +2.8mm



	Item #	Opening	Hinge Type	Fixing	Close Type	Box Qty
1	SALC7P6NE9AC	110°	Inset	Screw-on	Soft-close	150
	SALC7R6NE9AC	110°	Inset	Dowel	Soft-close	150
	SALC7J6NE9AC	110°	Inset	Logica	Soft-close	150
2	SALC7P6NE9AM	110°	Overlay	Screw-on	Soft-close	150
	SALC7R6NE9AM	110°	Overlay	Dowel	Soft-close	150

SALICE 200 SERIES HINGES



**110° Euro Hinges
200 Series**

SALICE

- 11mm deep cup
- Side-to-side adjustment from -1.5mm to +4.5mm
- Height adjustment +/-2mm
- Depth adjustment with DOMI snap-on mounting plates from -0.5mm to +2.8mm
- Depth adjustment with 200 Series mounting plates +2.8mm

Item #	Opening	Overlay	Fixing	Close Type	Box Qty
SALC2P4A99	110°	Full	Screw-On	Free Swing	300
SALC2R4A99	110°	Full	Dowel	Free Swing	300
SALC2P6A99	110°	Full	Screw-On	Self-close	300
SALC2R6A99	110°	Full	Dowel	Self-close	300
SALC276A99	110°	Full	Rapido	Self-close	300
SALC2J6A99	110°	Full	Logica	Self-close	300
SALC2P4D99	110°	1/2"	Screw-On	Free Swing	300
SALC2R4D99	110°	1/2"	Dowel	Free Swing	300
SALC2P6D99	110°	1/2"	Screw-On	Self-close	300
SALC2R6D99	110°	1/2"	Dowel	Self-close	300
SALC276D99	110°	1/2"	Rapido	Self-close	300
SALC2J6D99	110°	1/2"	Logica	Self-close	300
SALC2P4G99	110°	Half	Screw-On	Free Swing	300
SALC2R4G99	110°	Half	Dowel	Free Swing	300
SALC2P6G99	110°	Half	Screw-On	Self-close	300
SALC2R6G99	110°	Half	Dowel	Self-close	300
SALC276G99	110°	Half	Rapido	Self-close	300
SALC2J6G99	110°	Half	Logica	Self-close	300
SALC2P4P99	110°	Inset	Screw-On	Free Swing	300
SALC2R4P99	110°	Inset	Dowel	Free Swing	300
SALC2P6P99	110°	Inset	Screw-On	Self-close	300
SALC2R6P99	110°	Inset	Dowel	Self-close	300
SALC276P99	110°	Inset	Rapido	Self-close	300
SALC2J6P99	110°	Inset	Logica	Self-close	300

A
B
C
D
E
F
G
H
I
J
K
L
M
N
O
P
Q
R
S
T
U
V
W
X
Y

A SALICE 200 SERIES HINGES

**120° Euro Hinges
200 Series**
SALICE

- 11 mm deep cup
- Side-to-side adjustment from -1.5mm to +4.5mm
- Height adjustment +/-2mm
- Depth adjustment with DOMI snap-on mounting plates from -0.5mm to +2.8mm
- Depth adjustment with 200 Series mounting plates +2.8mm

Item #	Opening	Overlay	Fixing	Close Type	Box Qty
SALC2P8A99	120°	Full	Screw-On	Free Swing	300
SALC2R8A99	120°	Full	Dowel	Free Swing	300
SALC2P9A99	120°	Full	Screw-On	Self-close	300
SALC2R9A99	120°	Full	Dowel	Self-close	300
SALC279A99	120°	Full	Rapido	Self-close	300
SALC2J9A99	120°	Full	Logica	Self-close	300
SALC2P8D99	120°	1/2"	Screw-On	Free Swing	300
SALC2R8D99	120°	1/2"	Dowel	Free Swing	300
SALC2P9D99	120°	1/2"	Screw-On	Self-close	300
SALC2R9D99	120°	1/2"	Dowel	Self-close	300
SALC279D99	120°	1/2"	Rapido	Self-close	300
SALC2J9D99	120°	1/2"	Logica	Self-close	300
SALC2P8G99	120°	Half	Screw-On	Free Swing	300
SALC2R8G99	120°	Half	Dowel	Free Swing	300
SALC2P9G99	120°	Half	Screw-On	Self-close	300
SALC2R9G99	120°	Half	Dowel	Self-close	300
SALC279G99	120°	Half	Rapido	Self-close	300
SALC2J9G99	120°	Half	Logica	Self-close	300

SALICE 200 SERIES HINGES

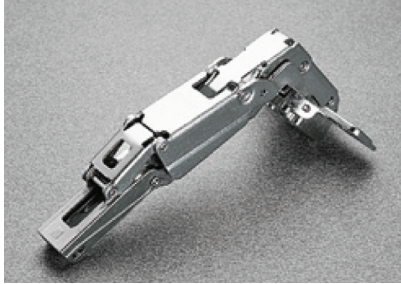

**165° Euro Hinges
200 Series**

SALICE

- 11mm deep cup
- Side-to-side adjustment from -1.5mm to +4.5mm
- Height adjustment +/-2mm
- Depth adjustment with DOMI snap-on mounting plates from -0.5mm to +2.8mm
- Depth adjustment with 200 Series mounting plates +2.8mm

Item #	Opening	Overlay	Fixing	Close Type	Box Qty
SALC2PEA99	165°	Full	Screw-On	Free Swing	100
SALC2REA99	165°	Full	Dowel	Free Swing	100
SALC2PFA99	165°	Full	Screw-On	Self-close	100
SALC2RFA99	165°	Full	Dowel	Self-close	100
SALC27FA99	165°	Full	Rapido	Self-close	100
SALC2JFA99	165°	Full	Logica	Self-close	100
SALC2PED99	165°	1/2"	Screw-On	Free Swing	100
SALC2RED99	165°	1/2"	Dowel	Free Swing	100
SALC2PFD99	165°	1/2"	Screw-On	Self-close	100
SALC2RFD99	165°	1/2"	Dowel	Self-close	100
SALC27FD99	165°	1/2"	Rapido	Self-close	100
SALC2JFD99	165°	1/2"	Logica	Self-close	100
SALC2PEG99	165°	Half	Screw-On	Free Swing	100
SALC2REG99	165°	Half	Dowel	Free Swing	100
SALC2PFG99	165°	Half	Screw-On	Self-close	100
SALC2RFG99	165°	Half	Dowel	Self-close	100
SALC27FG99	165°	Half	Rapido	Self-close	100
SALC2JFG99	165°	Half	Logica	Self-close	100
SALC2PEP99	165°	Inset	Screw-On	Free Swing	100
SALC2REP99	165°	Inset	Dowel	Free Swing	100
SALC2PEP99	165°	Inset	Screw-On	Self-close	100
SALC2RFP99	165°	Inset	Dowel	Self-close	100
SALC27FP99	165°	Inset	Rapido	Self-close	100
SALC2JFP99	165°	Inset	Logica	Self-close	100

A
B
C
D
E
F
G
H
I
J
K
L
M
N
O
P
Q
R
S
T
U
V
W
X
Y

A SALICE 200 SERIES THICK DOOR HINGES

**94° Thick Door Euro Hinges
200 Series**
SALICE

- 11mm deep cup
- For thick doors up to 32mm (1-1/4")
- Side-to-side adjustment from -1.5mm to +4.5mm
- Height adjustment +/-2mm
- Depth adjustment with DOMI snap-on mounting plates from -0.5mm to +2.8mm
- Depth adjustment with 200 Series mounting plates +2.8mm

Item #	Opening	Overlay	Fixing	Close Type	Box Qty
SALC2PAA99	94°	Full	Screw-On	Free Swing	300
SALC2RAA99	94°	Full	Dowel	Free Swing	300
SALC2PBA99	94°	Full	Screw-On	Self-close	300
SALC2RBA99	94°	Full	Dowel	Self-close	300
SALC27BA99	94°	Full	Rapido	Self-close	300
SALC2JBA99	94°	Full	Logica	Self-close	300
SALC2PBD99	94°	1/2"	Screw-On	Self-close	300
SALC2RBD99	94°	1/2"	Dowel	Self-close	300
SALC2PAG99	94°	Half	Screw-On	Free Swing	300
SALC2RAG99	94°	Half	Dowel	Free Swing	300
SALC2PBG99	94°	Half	Screw-On	Self-close	300
SALC2RBG99	94°	Half	Dowel	Self-close	300
SALC27BG99	94°	Half	Rapido	Self-close	300
SALC2JBG99	94°	Half	Logica	Self-close	300
SALC2PAP99	94°	Inset	Screw-On	Free Swing	300
SALC2RAP99	94°	Inset	Dowel	Free Swing	300
SALC2PBP99	94°	Inset	Screw-On	Self-close	300
SALC2RBP99	94°	Inset	Dowel	Self-close	300
SALC27BP99	94°	Inset	Rapido	Self-close	300
SALC2JBP99	94°	Inset	Logica	Self-close	300

SALICE 200 SERIES THICK DOOR HINGES

A
B
C
D
E
F
G
H
I
J
K
L
M
N
O
P
Q
R
S
T
U
V
W
X
Y



**94° Thick Door Euro Hinges
F Series**

SALICE

- 13mm deep cup
- For heavy thick doors - inset up to 40mm (1-1/2") or overlays up to 34mm (1-1/3")
- Hinge of choice for pocket door applications
- Side-to-side adjustment from -0.5mm to +5.5mm
- Height adjustment +/-2mm
- Depth adjustment with DOMI snap-on mounting plates from -0.5mm to +2.8mm
- Depth adjustment with 200 Series mounting plates +2.8mm

Item #	Opening	Overlay	Fixing	Close Type	Box Qty
SALCFA5A99	94°	Full	Screw-On	Free Swing	300
SALCFA7A99	94°	Full	Screw-On	Self-close	300
SALCFA5G99	94°	Half	Screw-On	Free Swing	300
SALCFA7G99	94°	Half	Screw-On	Self-close	300
SALCFA5P99	94°	Inset	Screw-On	Free Swing	300
SALCFA7P99	94°	Inset	Screw-On	Self-close	300



**155° Thick Door Euro Hinges
200 Series**

SALICE

- 11mm deep cup
- For thick doors up to 32mm (1-1/4")
- Side-to-side adjustment from -1.5mm to +4.5mm
- Height adjustment +/-2mm
- Depth adjustment with DOMI snap-on mounting plates from -0.5mm to +2.8mm
- Depth adjustment with 200 Series mounting plates +2.8mm

Item #	Opening	Overlay	Fixing	Close Type	Box Qty
SALC2PKA99	155°	Full - Zero Protrusion	Screw-On	Self-close	100
SALC2RKA99	155°	Full - Zero Protrusion	Dowel	Self-close	100
SALC2PHA99	155°	Full	Screw-On	Self-close	100
SALC2RKA99	155°	Full	Dowel	Self-close	100
SALC2PKD99	155°	1/2"	Screw-On	Self-close	100
SALC2RKD99	155°	1/2"	Dowel	Self-close	100
SALC2PKG99	155°	Half	Screw-On	Self-close	100
SALC2RKG99	155°	Half	Dowel	Self-close	100

A SALICE 200 SERIES SPECIALTY HINGES

B
C
D
E
F
G
H
I
J
K
L
M
N
O
P
Q
R
S
T
U
V
W
X
Y

**94° Specialty Hinges
200 Series**

SALICE

- 11mm deep cup
- Side-to-side adjustment from -1.5mm to +4.5mm
- Height adjustment +/-2mm
- Depth adjustment with DOMI snap-on mounting plates from -0.5mm to +2.8mm
- Depth adjustment with 200 Series mounting plates +2.8mm



Pie Corner Hinges					
Item #	Opening	Hinge Type	Fixing	Close Type	Box Qty
SALC2PYA99	94°	Pie Corner Hinge	Screw-On	Self-close	150
SALC2RYA99	94°	Pie Corner Hinge	Dowel	Self-close	150
SALC27YA99	94°	Pie Corner Hinge	Rapido	Self-close	150



Blind Corner Hinges - Inset					
Item #	Opening	Hinge Type	Fixing	Close Type	Box Qty
SALC2PBN99AC	94°	Blind Corner Hinge - Inset	Screw-On	Self-close	150
SALC2RBN99AC	94°	Blind Corner Hinge - Inset	Dowel	Self-close	150
SALC27BN99AC	94°	Blind Corner Hinge - Inset	Rapido	Self-close	150
SALC2JBN99AC	94°	Blind Corner Hinge - Inset	Logica	Self-close	150



Blind Corner Hinges - Overlay					
Item #	Opening	Hinge Type	Fixing	Close Type	Box Qty
SALC2P6N99AM	94°	Blind Corner Hinge - Overlay	Screw-On	Self-close	150
SALC2R6N99AM	94°	Blind Corner Hinge - Overlay	Dowel	Self-close	150
SALC276N99AM	94°	Blind Corner Hinge - Overlay	Rapido	Self-close	150
SALC2J6N99AM	94°	Blind Corner Hinge - Overlay	Logica	Self-close	150



Corner Hinges +15°					
Item #	Opening	Hinge Type	Fixing	Close Type	Box Qty
SALC2PBZ99	94°	Corner Hinge +15°	Screw-On	Self-close	150
SALC2RBZ99	94°	Corner Hinge +15°	Dowel	Self-close	150
SALC27BZ99	94°	Corner Hinge +15°	Rapido	Self-close	150
SALC2JBZ99	94°	Corner Hinge +15°	Logica	Self-close	150

SALICE 200 SERIES SPECIALTY HINGES

SALICE

A
B
C
D
E
F
G
H
I
J
K
L
M
N
O
P
Q
R
S
T
U
V
W
X
Y

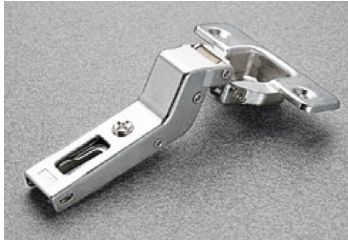

Corner Hinges +24°					
Item #	Opening	Hinge Type	Fixing	Close Type	Box Qty
SALC2PBU99	94°	Corner Hinge +24°	Screw-On	Self-close	150
SALC2RBU99	94°	Corner Hinge +24°	Dowel	Self-close	150
SALC27BU99	94°	Corner Hinge +24°	Rapido	Self-close	150
SALC2JBU99	94°	Corner Hinge +24°	Logica	Self-close	150



Corner Hinges +30°					
Item #	Opening	Hinge Type	Fixing	Close Type	Box Qty
SALC2PBE99	94°	Corner Hinge +30°	Screw-On	Self-close	150
SALC2RBE99	94°	Corner Hinge +30°	Dowel	Self-close	150
SALC27BE99	94°	Corner Hinge +30°	Rapido	Self-close	150
SALC2JBE99	94°	Corner Hinge +30°	Logica	Self-close	150



Corner Hinges +30° - Overlay					
Item #	Opening	Hinge Type	Fixing	Close Type	Box Qty
SALC2PBT99	94°	Corner Hinge +30° - Overlay	Screw-On	Self-close	150
SALC2RBT99	94°	Corner Hinge +30° - Overlay	Dowel	Self-close	150
SALC27BT99	94°	Corner Hinge +30° - Overlay	Rapido	Self-close	150
SALC2JBT99	94°	Corner Hinge +30° - Overlay	Logica	Self-close	150



Corner Hinges +37°					
Item #	Opening	Hinge Type	Fixing	Close Type	Box Qty
SALC2PBK99	94°	Corner Hinge +37°	Screw-On	Self-close	150
SALC2RBK99	94°	Corner Hinge +37°	Dowel	Self-close	150
SALC27BK99	94°	Corner Hinge +37°	Rapido	Self-close	150
SALC2JBK99	94°	Corner Hinge +37°	Logica	Self-close	150



Corner Hinges +45° - Twin Application					
Item #	Opening	Hinge Type	Fixing	Close Type	Box Qty
SALC2PBM99AC	94°	Corner Hinge +45° - Twin Application	Screw-On	Self-close	150
SALC2RBM99AC	94°	Corner Hinge +45° - Twin Application	Dowel	Self-close	150
SALC27BM99AC	94°	Corner Hinge +45° - Twin Application	Rapido	Self-close	150
SALC2JBM99AC	94°	Corner Hinge +45° - Twin Application	Logica	Self-close	150

A SALICE 200 SERIES SPECIALTY HINGES

B
C
D
E
F
G
H
I
J
K
L
M
N
O
P
Q
R
S
T
U
V
W
X
Y

SALICE



Corner Hinges +45°					
Item #	Opening	Hinge Type	Fixing	Close Type	Box Qty
SALC2PBM99	94°	Corner Hinge +45°	Screw-On	Self-close	150
SALC2RBM99	94°	Corner Hinge +45°	Dowel	Self-close	150
SALC27BM99	94°	Corner Hinge +45°	Rapido	Self-close	150
SALC2JBM99	94°	Corner Hinge +45°	Logica	Self-close	150



Corner Hinges +45° - Overlay					
Item #	Opening	Hinge Type	Fixing	Close Type	Box Qty
SALC2PBV99	94°	Corner Hinge +45° - Overlay	Screw-On	Self-close	150
SALC2RBV99	94°	Corner Hinge +45° - Overlay	Dowel	Self-close	150
SALC27BV99	94°	Corner Hinge +45° - Overlay	Rapido	Self-close	150
SALC2JBV99	94°	Corner Hinge +45° - Overlay	Logica	Self-close	150



Negative Angle Hinges -30°					
Item #	Opening	Hinge Type	Fixing	Close Type	Box Qty
SALC2PBW99	94°	Negative Angle Hinge -30°	Screw-On	Self-close	150
SALC2RBW99	94°	Negative Angle Hinge -30°	Dowel	Self-close	150
SALC27BW99	94°	Negative Angle Hinge -30°	Rapido	Self-close	150
SALC2JBW99	94°	Negative Angle Hinge -30°	Logica	Self-close	150



Negative Angle Hinges -45°					
Item #	Opening	Hinge Type	Fixing	Close Type	Box Qty
SALC2PBH99	94°	Negative Angle Hinge -45°	Screw-On	Self-close	150
SALC2RBH99	94°	Negative Angle Hinge -45°	Dowel	Self-close	150
SALC27BH99	94°	Negative Angle Hinge -45°	Rapido	Self-close	150
SALC2JBH99	94°	Negative Angle Hinge -45°	Logica	Self-close	150

SALICE UNIVERSAL HINGES

A
B
C
D
E
F
G
H
I
J
K
L
M
N
O
P
Q
R
S
T
U
V
W
X
Y



**110° Universal Hinges for Wood Doors
Universal Series**

SALICE

- Provides solutions for special applications including lipped doors and molded profiles
- 9mm deep metal cup
- Side-to-side adjustment from -1.5mm to +4.5mm
- Height adjustment +/-2mm
- Depth adjustment with DOMI snap-on mounting plates from -0.5mm to +2.8mm
- Depth adjustment with 200 Series mounting plates +2.8mm

Item #	Opening	Overlay	Fixing	Close Type	Box Qty
SALCBP2AE9	110°	Full	Screw-On	Soft-close	150
SALCBP2AC9	110°	Full	Screw-On	Self-close	150
SALCBPQAC9	110°	Full	Screw-On	Push Open	150
SALCBR2AE9	110°	Full	Dowel	Soft-close	150
SALCBR2AC9	110°	Full	Dowel	Self-close	150
SALCBRQAC9	110°	Full	Dowel	Push Open	150

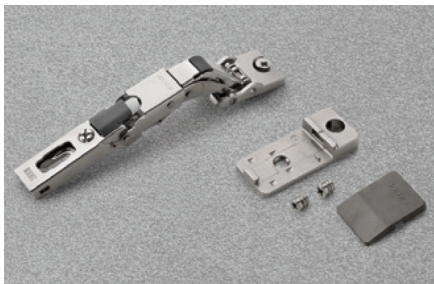

**110° Universal Hinges for Thin Doors
Universal Series**

SALICE

- Hinges for doors with a minimum thickness of 8mm made with special materials
- Side-to-side adjustment from -1.5mm to +4.5mm
- Height adjustment +/-2mm
- Depth adjustment with DOMI snap-on mounting plates from -0.5mm to +2.8mm
- Depth adjustment with 200 Series mounting plates +2.8mm

Item #	Opening	Overlay	Close Type	Box Qty
SALCBY2AE9	110°	Full	Soft-close	150
SALCBY2AC9	110°	Full	Self-close	150
SALCBYQAC9	110°	Full	Push Open	150

A SALICE UNIVERSAL HINGES

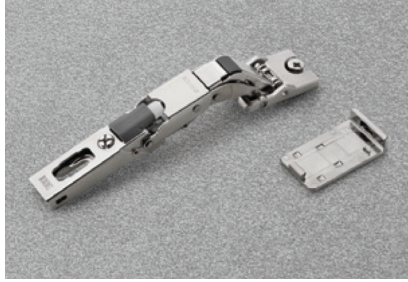

**110° Universal Hinges for Glass Doors
Universal Series**

SALICE

- Hinges for glass doors - no drilling of the glass is required
- Side-to-side adjustment from -1.5mm to +4.5mm
- Height adjustment +/-2mm
- Depth adjustment with DOMI snap-on mounting plates from -0.5mm to +2.8mm
- Depth adjustment with 200 Series mounting plates +2.8mm

Item #	Opening	Overlay	Close Type	Box Qty
SALCBG2AE9	110°	Full	Soft-close	150
SALCBG2AC9	110°	Full	Self-close	150
SALCBGQAC9	110°	Full	Push Open	150

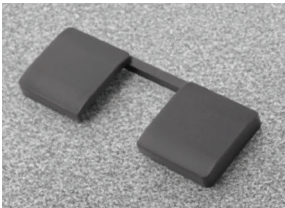

Universal Hinge Accessories			
	Item #	Description	Box Qty
1	SALSBXX85A9	Plastic Flange Cover Cap for 35mm Cup	1,000
2	SALDBDESN6	Universal Hinge Add-On Soft-close Device	300
3	SALSBAX78A6SN	Universal Hinge Decorative Cover	300
4	SALSBA237X6	Universal Hinge 90° Restriction Clip	2000



SALICE PUSH HINGE SYSTEM

A
B
C
D
E
F
G
H
I
J
K
L
M
N
O
P
Q
R
S
T
U
V
W
X
Y



**110° Push Hinges
200 Series**

SALICE

- 11 mm deep cup
- For use with Push Self-Opening Hinge system

Item #	Opening	Overlay	Fixing	Close Type	Box Qty
SALC2PPA99	110°	Full	Screw-On	Push Open	100
SALC2RPA99	110°	Full	Dowel	Push Open	100
SALC2PPG99	110°	Half	Screw-On	Push Open	100
SALC2RPG99	110°	Half	Dowel	Push Open	100
SALC2PPP99	110°	Inset	Screw-On	Push Open	100
SALC2RPP99	110°	Inset	Dowel	Push Open	100

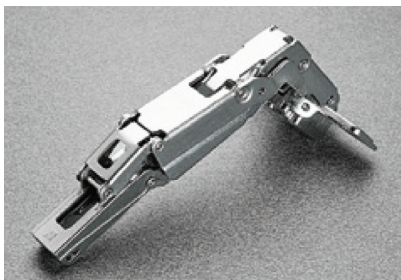

**165° Push Hinges
200 Series**

SALICE

- 11 mm deep cup
- For use with Push Self-Opening Hinge system

Item #	Opening	Overlay	Fixing	Close Type	Box Qty
SALC2PSA99	165°	Full	Screw-On	Push Open	100
SALC2RSA99	165°	Full	Dowel	Push Open	100
SALC2PSG99	165°	Half	Screw-On	Push Open	100
SALC2RSG99	165°	Half	Dowel	Push Open	100
SALC2PSP99	165°	Inset	Screw-On	Push Open	100
SALC2RSP99	165°	Inset	Dowel	Push Open	100



**94° Thick Door Push Hinges
200 Series**

SALICE

- 11 mm deep cup
- For use with Push Self-Opening Hinge system

Item #	Opening	Overlay	Fixing	Close Type	Box Qty
SALC2PVA99	94°	Full	Screw-On	Push Open	100
SALC2RVA99	94°	Full	Dowel	Push Open	100
SALC2PVG99	94°	Half	Screw-On	Push Open	100
SALC2RVG99	94°	Half	Dowel	Push Open	100
SALC2PVP99	94°	Inset	Screw-On	Push Open	100
SALC2RVP99	94°	Inset	Dowel	Push Open	100

A SALICE PUSH HINGE SYSTEM

B
C
D
E
F
G
H
I
J
K
L
M
N
O
P
Q
R
S
T
U
V
W
X
Y

Push System Latches & Accessories

SALICE



Latches with Assembly Stop Tabs - For Woodscrew Fixing			
Beige Item #	Gray Item #	Black Item #	Box Qty
SALDP3SNB	SALDP3SNG	SALDP3SN3	300

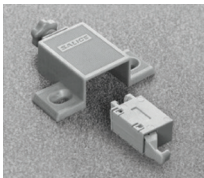
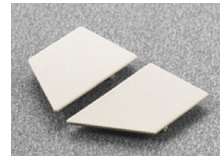
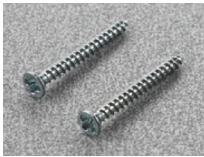

Adjustable Latches - Single Adapter with Lateral/Depth Adjustment			
Beige Item #	Gray Item #	Black Item #	Box Qty
SALDP4SNB	SALDP4SNG	SALDP4SN3	300



Adjustable Latches - Double Adapter with Lateral/Depth Adjustment			
Beige Item #	Gray Item #	Black Item #	Box Qty
SALDP5SNB	SALDP5SNG	SALDP5SN3	300



Retaining Catches for Wood Doors - Overlay Applications			
Beige Item #	Gray Item #	Black Item #	Box Qty
SALDP29SNB	SALDP29SNG	SALDP29SN3	300

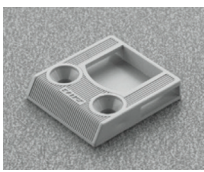

Retaining Catches for Wood Doors - Inset Applications			
Beige Item #	Gray Item #	Black Item #	Box Qty
SALDP29SNBR	SALDP29SNGR	SALDP29SN3R	300



Insertion Tool for Aligning Retaining Catch DP29SN Series			
Item #			
SALDP50SNO			

SALICE PUSH HINGE SYSTEM

Release Devices, Adapters, & Retaining Catches

SALICE

A
B
C
D
E
F
G
H
I
J
K
L
M
N
O
P
Q
R
S
T
U
V
W
X
Y



Release Devices & Adapters			
Item #	Description	Box Qty	
1	SALDPMSNB	10mm Release Device - 40mm Length	250
2	SALDPASNB	Additional Release Device for DPM Series	250
3	SALDP82XXBR	Beige Adjustable Plastic Adapter for Release Device - 8+16mm Drilling	500
	SALDP82XXGR	Gray Adjustable Plastic Adapter for Release Device - 8+16mm Drilling	500
	SALDP82XX3R	Black Adjustable Plastic Adapter for Release Device - 8+16mm Drilling	500
4	SALDP84SNBR	Beige Adjustable Plastic Adapter for Release Device - with Stop Tabs	500
	SALDP84XX3R	Black Adjustable Plastic Adapter for Release Device - with Stop Tabs	500

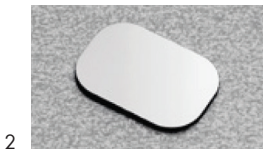
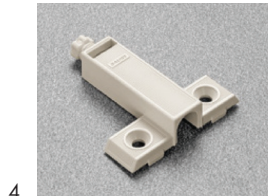

Retaining Catches			
Item #	Description	Box Qty	
1	SALDP28SN9	11.5mm Retaining Catch to be Inserted	250
2	SALDP38XX91	20x14mm Retaining Catch with Adhesive	250
3	SALDP39XXG	16.6mm Adjustable Magnetic Retaining Catch	250

A SALICE AIR HINGE SYSTEM



AIR Hinges Used with Wood Doors



Nickel Plating



Titanium Plating



AIR Hinges Used with Aluminum Framed Glass Doors

Salice Air Hinge System

SALICE

Features:

- Innovative award winning hinge system for contemporary cabinetry and furniture
- Although small in profile, the AIR hinge provides full functionality and superior strength
- Uses only 2 hinges in cabinet designs that would otherwise require 3 or even 4 hinges
- Available in both Soft-close or Push-to-open versions in Nickel or Titanium finishes
- 6-way cam adjustable for height, depth, and lateral adjustment

Specifications:

- 105° opening angle
- Minimum door thickness: 3/4" (18mm)
- Maximum door thickness: 1-1/2" (38mm)
- Maximum door weight (2 hinges): 44 lbs.
- Maximum door size: 84" (2100mm) x 24" (600mm)
- Wood door edge bore drilling: 3mm - 6mm
- Aluminum door edge bore drilling: 4mm

AIR Hinges

Item #	Type	Finish	Box Qty
SALCEL6XE9XXV	Soft-Close	Nickel	12
SALCEL6XE6XXV	Soft-Close	Titanium	12
SALCELPX99XXV	Push-to-open	Nickel	12
SALCELPX66XXV	Push-to-open	Titanium	12

* Polybag set includes 2 hinges (one left and one right) and assembly screws

AIR Hinge Templates

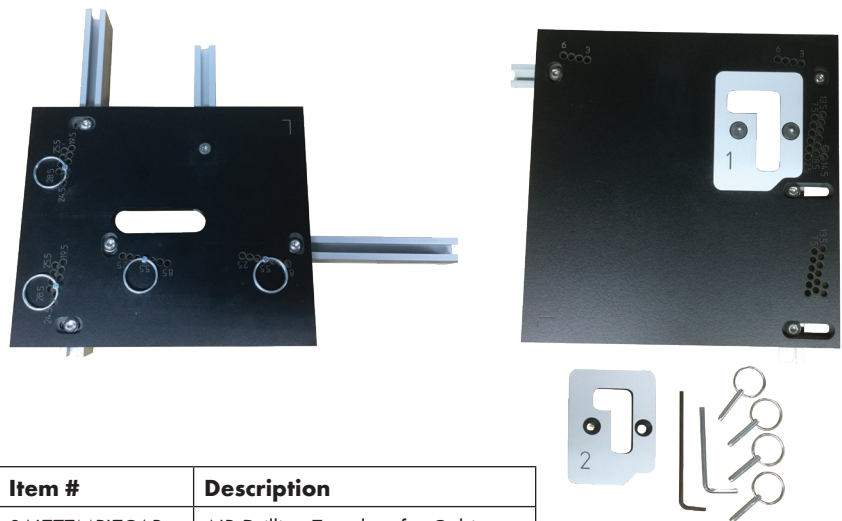

Item #	Description
SALTZTMPLTCAB	AIR Drilling Template for Cabinet
SALTZTMPLTDR	AIR Drilling Template for Door

SALICE EURO HINGE 1 CAM BASEPLATES

A
B
C
D
E
F
G
H
I
J
K
L
M
N
O
P
Q
R
S
T
U
V
W
X
Y

SALICE

1 Cam Screw-in Baseplates



0mm Item #	3mm Item #	6mm Item #	9mm Item #	12mm Item #	18mm Item #	Finish	Box Qty
SALBAV3L09F	SALBAV3L39F	SALBAV3L69F	-	-	-	Steel	300
SALBAV3E09F	SALBAV3E39F	SALBAV3E69F	SALBAV3E99F	SALBAV3EC9F	SALBAV3EV9F	Die Cast	300

1 Cam Baseplates with Pre-Mounted Euro Screws



0mm Item #	3mm Item #	6mm Item #	9mm Item #	12mm Item #	18mm Item #	Finish	Box Qty
SALBAVGL09F/16	SALBAVGL39F/16	SALBAVGL69F/16	-	-	-	Steel	300
SALBAVGE09F/16	SALBAVGE39F/16	SALBAVGE69F/16	SALBAVGE99F/16	SALBAVGEC9F/16	SALBAVGEV9F/16	Die Cast	300

1 Cam Baseplates with 5mm Expansion Dowels



Item #	Height	Cams	Type	Finish	Box Qty
SALBAV4L09F/16	0mm	1	5mm Expansion Dowels	Steel	300
SALBAV4L39F/16	3mm	1	5mm Expansion Dowels	Steel	300

1 Cam Screw-in Baseplates - New Steel



Item #	Height	Cams	Type	Finish	Box Qty
SALBAV3M09F	0mm	1	Screw-in	Steel	300
SALBAV3M39F	3mm	1	Screw-in	Steel	300

1 Cam Baseplates with Pre-Mounted Euro Screws - New Steel



Item #	Height	Cams	Type	Finish	Box Qty
SALBAVGM09F/16	0mm	1	Pre-mounted Euro Screws	Steel	300
SALBAVGM29F/16	2mm	1	Pre-mounted Euro Screws	Steel	300
SALBAVGM39F/16	3mm	1	Pre-mounted Euro Screws	Steel	300

1 Cam Baseplates with 5mm Expansion Dowels - New Steel



Item #	Height	Cams	Type	Finish	Box Qty
SALBAV4M09F/16	0mm	1	5mm Expansion Dowels	Steel	300
SALBAV4M39F/16	3mm	1	5mm Expansion Dowels	Steel	300

A SALICE EURO HINGE 2 CAM BASEPLATES

B

2 Cam Screw-in Baseplates - Steel
SALICE

Item #	Height	Cams	Type	Finish	Box Qty
SALBAR3L09F	0mm	2	Screw-in	Steel	300
SALBAR3L39F	3mm	2	Screw-in	Steel	300
SALBAR3L69F	6mm	2	Screw-in	Steel	300

C

D

E

F

G

2 Cam Baseplates with Pre-Mounted Euro Screws - Steel

Item #	Height	Cams	Type	Finish	Box Qty
SALBARGL09F/16	0mm	2	Pre-mounted Euro Screws	Steel	300
SALBARGL39F/16	3mm	2	Pre-mounted Euro Screws	Steel	300
SALBARGL69F/16	6mm	2	Pre-mounted Euro Screws	Steel	300

H

I

J

K

2 Cam Inline Screw-in Baseplates - Die Cast

Item #	Height	Cams	Type	Finish	Box Qty
SALBAP3R09	0mm	2	Screw-in	Die Cast	300
SALBAP3R29	2mm	2	Screw-in	Die Cast	300
SALBAP3R39	3mm	2	Screw-in	Die Cast	300
SALBAP3R69	6mm	2	Screw-in	Die Cast	300
SALBAP3R99	9mm	2	Screw-in	Die Cast	300
SALBAP3RC9	12mm	2	Screw-in	Die Cast	300

L

M

N

O

P

Q

2 Cam Inline Baseplates with Pre-Mounted Euro Screws - Die Cast

Item #	Height	Cams	Type	Finish	Box Qty
SALBAPGR09/16	0mm	2	Pre-mounted Euro Screws	Die Cast	300
SALBAPGR29/16	2mm	2	Pre-mounted Euro Screws	Die Cast	300
SALBAPGR39/16	3mm	2	Pre-mounted Euro Screws	Die Cast	300
SALBAPGR69/16	6mm	2	Pre-mounted Euro Screws	Die Cast	300

R

S

T

U

V

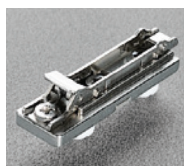
2 Cam Inline Baseplates with 10mm Dowels - Die Cast

Item #	Height	Cams	Type	Finish	Box Qty
SALBAP7R09	0mm	2	10mm Dowels	Die Cast	300
SALBAP7R29	2mm	2	10mm Dowels	Die Cast	300
SALBAP7R39	3mm	2	10mm Dowels	Die Cast	300
SALBAP7R69	6mm	2	10mm Dowels	Die Cast	300

W

X

Y

SALICE EURO HINGE 2 CAM BASEPLATES

A
B
C
D
E
F
G
H
I
J
K
L
M
N
O
P
Q
R
S
T
U
V
W
X
Y

2 Cam Screw-in Baseplates - Die Cast

SALICE



Item #	Height	Cams	Type	Finish	Box Qty
SALBAR3R09	0mm	2	Screw-in	Die Cast	300
SALBAR3R29	2mm	2	Screw-in	Die Cast	300
SALBAR3R39	3mm	2	Screw-in	Die Cast	300
SALBAR3R69	6mm	2	Screw-in	Die Cast	300
SALBAR3R99	9mm	2	Screw-in	Die Cast	300
SALBAR3RC9	12mm	2	Screw-in	Die Cast	300
SALBAR3RV9	18mm	2	Screw-in	Die Cast	300

2 Cam Baseplates with Pre-Mounted Euro Screws - Die Cast



Item #	Height	Cams	Type	Finish	Box Qty
SALBARGR09/16	0mm	2	Pre-mounted Euro Screws	Die Cast	300
SALBARGR29/16	2mm	2	Pre-mounted Euro Screws	Die Cast	300
SALBARGR39/16	3mm	2	Pre-mounted Euro Screws	Die Cast	300
SALBARGR69/16	6mm	2	Pre-mounted Euro Screws	Die Cast	300
SALBARGR99/16	9mm	2	Pre-mounted Euro Screws	Die Cast	300
SALBARGRC9/16	12mm	2	Pre-mounted Euro Screws	Die Cast	300
SALBARGRV9/16	18mm	2	Pre-mounted Euro Screws	Die Cast	300

2 Cam Baseplates with Short Pre-Mounted Euro Screws - For Twin Application - Die Cast



Item #	Height	Cams	Type	Finish	Box Qty
SALBARGR09/20	0mm	2	Pre-mounted Short Euro Screws	Die Cast	300
SALBARGR29/20	2mm	2	Pre-mounted Short Euro Screws	Die Cast	300
SALBARGR39/20	3mm	2	Pre-mounted Short Euro Screws	Die Cast	300
SALBARGR69/20	6mm	2	Pre-mounted Short Euro Screws	Die Cast	300
SALBARGR99/20	9mm	2	Pre-mounted Short Euro Screws	Die Cast	300

A SALICE EURO HINGE 2 CAM BASEPLATES

B

C

D

E

F

G

H

I

J

K

L

M

N

O

P

Q

R

S

T

U

V

W

X

Y

2 Cam Baseplates with 5mm Expansion Dowels - Die Cast
SALICE

Item #	Height	Cams	Type	Finish	Box Qty
SALBAR4R09/16	0mm	2	5mm Expansion Dowels	Die Cast	300
SALBAR4R29/16	2mm	2	5mm Expansion Dowels	Die Cast	300
SALBAR4R39/16	3mm	2	5mm Expansion Dowels	Die Cast	300
SALBAR4R69/16	6mm	2	5mm Expansion Dowels	Die Cast	300

2 Cam Thick Screw-in Baseplates - Die Cast

Item #	Height	Cams	Type	Finish	Box Qty
SALBAR3RZ9	21mm	2	Screw-in	Die Cast	150
SALBAR3RY9	24mm	2	Screw-in	Die Cast	150
SALBAR3RU9	27mm	2	Screw-in	Die Cast	150
SALBAR3RM9	30mm	2	Screw-in	Die Cast	150

2 Cam Thick Baseplates with Pre-Mounted Euro Screws - Die Cast

Item #	Height	Cams	Type	Finish	Box Qty
SALBARGRZ/16	21mm	2	Pre-mounted Euro Screws	Die Cast	150
SALBARGRY9/16	24mm	2	Pre-mounted Euro Screws	Die Cast	150
SALBARGRU9/16	27mm	2	Pre-mounted Euro Screws	Die Cast	150
SALBARGRM/16	30mm	2	Pre-mounted Euro Screws	Die Cast	150

SALICE EURO HINGE FACE FRAME BASEPLATES

A
B
C
D
E
F
G
H
I
J
K
L
M
N
O
P
Q
R
S
T
U
V
W
X
Y

SALICE

1 Cam Screw-in Face Frame Baseplates - Die Cast



Item #	Height	Cams	Type	Finish	Box Qty
SALBAU3E19	1mm	1	Screw-in	Die Cast	300
SALBAU3E49	4mm	1	Screw-in	Die Cast	300

1 Cam Screw-in Face Frame Baseplates - Steel



Item #	Height	Cams	Type	Finish	Box Qty
SALBAU3L19	1mm	1	Screw-in	Steel	300
SALBAU3L49	4mm	1	Screw-in	Steel	300

2 Cam Screw-in Face Frame Baseplates - Die Cast



Item #	Height	Cams	Type	Finish	Box Qty
SALBAU3R19	1mm	2	Screw-in	Die Cast	300
SALBAU3R49	4mm	2	Screw-in	Die Cast	300
SALBAU3R69	6mm	2	Screw-in	Die Cast	300

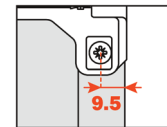

2 Cam Screw-in Face Frame Baseplates for Refacers - Die Cast

Item #	Height	Cams	Type	Finish	Box Qty
SALBAU3R19XR	1mm	2	Screw-in for Refacers	Die Cast	300
SALBAU3R49XR	4mm	2	Screw-in for Refacers	Die Cast	300
SALBAU3R69XR	6mm	2	Screw-in for Refacers	Die Cast	300

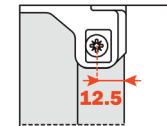

2 Cam Screw-in Inset Face Frame Baseplate - Die Cast



Item #	Height	Cams	Type	Finish	Box Qty
SALBAL3R59	5mm	2	Screw-in	Die Cast	300

2 Cam Screw-in Rear Flange Face Frame Baseplate - Die Cast



Item #	Height	Cams	Type	Finish	Box Qty
SALBAOR59	5mm	2	Screw-in	Die Cast	150

2 Cam Screw-in Large Overlay Face Frame Baseplate - Die Cast

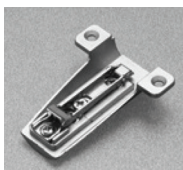

Item #	Height	Cams	Type	Finish	Box Qty
SALBAM3R09	0mm	2	Screw-in	Die Cast	300

A SALICE HINGE SOFT-CLOSE ADAPTERS

B
C
D
E
F
G
H
I
J
K
L
M
N
O
P
Q
R
S
T
U
V
W
X
Y



**Universal Face Frame Cabinet Soft-Close
Salice Type "U" Smove Adjustable Soft-Close**

SALICE

- One piece single face frame design for all door styles
- Soft top to prevent door marring and easily mounted using a single #6 wood screw
- Adjustable (screw turn) tension for varying door sizes/weights
- Consistent spacing using indexing tab
- Does not interfere with space needed for rollout shelves or access to hinge adjustment screws
- Convenient, single part ordering (Smove and housing as one integrated part)

Right Side Mount Item #	Left Side Mount Item #	Box Qty
SALDOUROG	SALDOULOG	150

Accessory Items	
Item #	Description
AN608520	Vix Bit, 1/4" Hex Shank, #6 Screw
AN630520	Replacement Bit for above

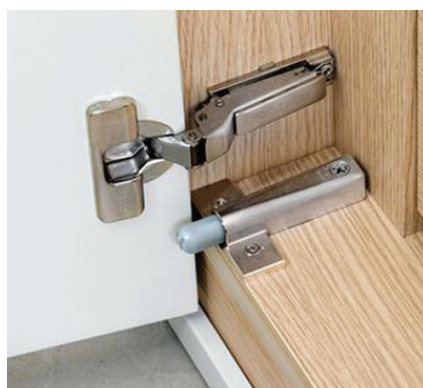

**Universal Cabinet Soft-Close
Salice Type "L" Smove Adjustable Soft-Close**

SALICE

- One piece soft-close device is suitable for frame or frameless cabinets
- Can be used with either Salice "S" Series or 200 Series face frame applications
- Three models offer varying resistance levels to adapt to door styles, weights & overlay applications
- Additional tension adjustment is provided by tightening/loosening screw on the Type L Smove
- Attached using two common #6 x 5/8" wood screws
- Precise positioning established using the integrated front locator tab
- Precise, consistent positioning from cabinet side by means of assembly tabs
- Non handed. One Smove for either left or right side mounting
- Only 1 Smove Type L required per door

Medium Tension Item #	High Tension Item #	Extra High Tension Item #	Box Qty
SALDOLHSNG For doors with 2 or 3 hinges (Black piston)	SALDOL8SNG For doors with 4 hinges (Orange piston)	SALDOL9SNG For extremely heavy doors only (Beige piston)	150

Accessory Items	
Item #	Description
AN608520	Vix Bit, 1/4" Hex Shank, #6 Screw
AN630520	Replacement Bit for above

SALICE EURO HINGE ACCESSORIES

Angle Restriction Clips

SALICE

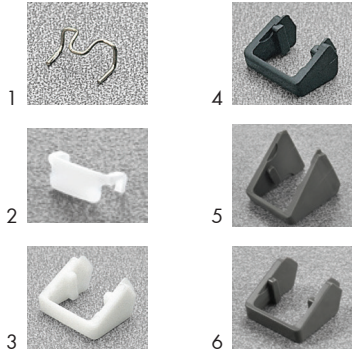

Item #	Description	Box Qty
1	SALS2A637XF 86° Restriction Clip for All 200 & 700 Series Hinges	500
2	SALS1E637XY 86° Restriction Clip for All 100 & 700 Series Hinges	500
3	SALS2BF37XY 110° Restriction Clip for 155°/165° Hinges	2,000
4	SALS2AF37X3 125° Restriction Clip for 155°/165° Hinges	2,000
5	SALS2BM37XG 92° Restriction Clip for 155° Zero Protrusion Hinges	2,000
6	SALS2AM37XG 120° Restriction Clip for 155° Zero Protrusion Hinges	2,000

Hinge Arm Cover Caps



Item #	Description	Finish	Box Qty
1	SALS2BX83H9 Cover Cap for 100, 200, and 700 Series Hinges	Steel	5,000
2	SALS2XX83A1 Cover Cap for 100, 200, and 700 Series Hinges	White	5,000
	SALS2XX83A3 Cover Cap for 100, 200, and 700 Series Hinges	Black	5,000

Flange Cover Caps



Item #	Description	Finish	Box Qty
1	SALS2XX85H9 Steel Flange Cover Cap	Nickel	3,000

Spacers

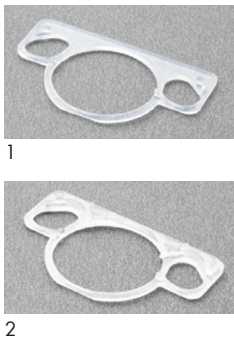

Item #	Description	Box Qty
1	SALS2XF86KT 1.8mm Spacer for 155° Hinges	1,200
2	SALS2XX86BT 0.6mm Spacer for 94°, 105°, and 110° Hinges	1,200
	SALS2XX86AT 1.2mm Spacer for 94°, 105°, and 110° Hinges	1,200
	SALS2XX86KT 1.8mm Spacer for 94°, 105°, and 110° Hinges	1,200

Variable Angle Adapters

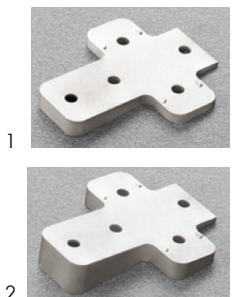

Item #	Description	Box Qty
1	SALSAV354X9R +5° Die Cast Adapter for Mounting Plates	1,200
2	SALSAV354X9S +10° Die Cast Adapter for Mounting Plates	1,200

A
B
C
D
E
F
G
H
I
J
K
L
M
N
O
P
Q
R
S
T
U
V
W
X
Y

A SALICE SILENTIA SOFT-CLOSE FACE FRAME HINGES

B
C
D
E
F
G
H
I
J
K
L
M
N
O
P
Q
R
S
T
U
V
W
X
Y

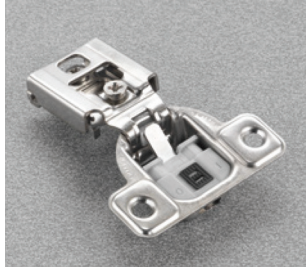

106° Silentia Excentra 2-Cam Face Frame Hinges

SALICE

- 11mm (7/16") cup depth
- Variable drilling distance of 2.5mm - 6mm
- Minimum door thickness 14mm (9/16")
- Maximum door thickness 22mm (7/8")
- Wraparound (front and rear tabs)

Overlay	Screw-On Item #	Dowel Item #	Box Qty
3/8"	SALCUP39D9	SALCUR39D9	300
1/2"	SALCUP37D9	SALCUR37D9	300
9/16"	SALCUP36D9	SALCUR36D9	300
5/8"	SALCUP35D9	SALCUR35D9	300
3/4"	SALCUP34D9	SALCUR34D9	300
1"	SALCUP32D9	SALCUR32D9	300
1-1/4"	SALCUP3AD9	SALCUR3AD9	300
1-5/16"	SALCUP3BD9R	SALCUR3BD9R	300
1-3/8"	SALCUP3CD9R	SALCUR3CD9R	300
1-7/16"	SALCUP3DD9	SALCUR3DD9	300
1-9/16"	SALCUP3ED9	SALCUR3ED9	300



106° Silentia Excenthree 3-Cam Face Frame Hinges

SALICE

- 11mm (7/16") cup depth
- Variable drilling distance of 2.5mm - 6mm
- Minimum door thickness 14mm (9/16")
- Maximum door thickness 22mm (7/8")
- Edgemount (front tabs only)

Overlay	Screw-On Item #	Dowel Item #	Box Qty
1/2"	SALCUP37D9R	SALCUR37D9R	300
9/16"	SALCUP36D9R	SALCUR36D9R	300
5/8"	SALCUP35D9R	SALCUR35D9R	300
3/4"	SALCUP34D9R	SALCUR34D9R	300
1"	SALCUP32D9R	SALCUR32D9R	300
1-1/4"	SALCUP3AD9R	SALCUR3AD9R	300
1-5/16"	SALCUP3BD9R	SALCUR3BD9R	300
1-3/8"	SALCUP3CD9R	SALCUR3CD9R	300
1-7/16"	SALCUP3DD9R	SALCUR3DD9R	300
1-9/16"	SALCUP3ED9R	SALCUR3ED9R	300

SALICE SILENTIA SOFT-CLOSE FACE FRAME HINGES

Silentia Soft-Close Face Frame Accessories

SALICE

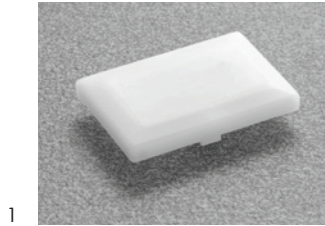

1

Cover Caps for 1/2" to 3/4" Overlays				
	Item #	Description	Color	Box Qty
1	SALSUXX83C1	Nylon Cover Cap	White	5,000
2	SALSUXX83CG	Nylon Cover Cap	Grey	5,000
3	SALSUXX83C6	Nylon Cover Cap	Titanium	5,000

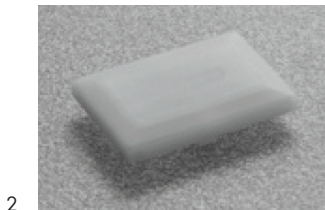

2

Cover Caps for 1" to 1-3/8" Overlays				
	Item #	Description	Color	Box Qty
4	SALSUXX83L1	Nylon Cover Cap	White	5,000
5	SALSUXX83LG	Nylon Cover Cap	Grey	5,000
6	SALSUXX83L6	Nylon Cover Cap	Titanium	5,000



3

Angle Restriction Clip				
	Item #	Description	Color	Box Qty
7	SALSUP337XG	86° Restriction Clip	Grey	500

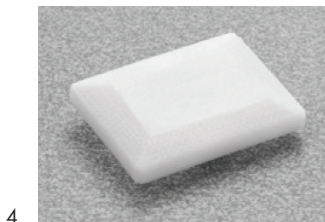

4

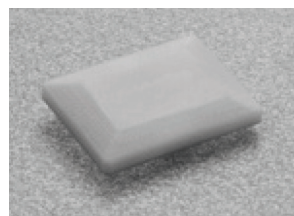

5

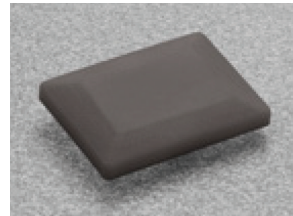

6



7

A
B
C
D
E
F
G
H
I
J
K
L
M
N
O
P
Q
R
S
T
U
V
W
X
Y

A SALICE SELF-CLOSE FACE FRAME HINGES

B
C
D
E
F
G
H
I
J
K
L
M
N
O
P
Q
R
S
T
U
V
W
X
Y

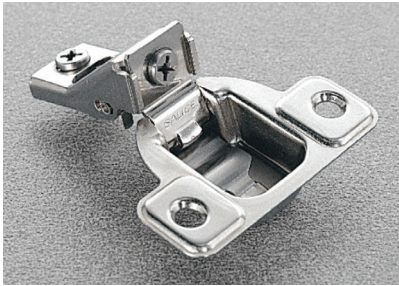

**106° Excentra 2-Cam Face Frame Hinges
S Series**

SALICE

- 11mm (7/16") cup depth
- Stamped steel
- Drilling distance fixed at 2.5mm (3/32")

Overlay	Screw-On Item #	Dowel Item #	Box Qty
1/4"	SALCSP3Y99	SALCSR3Y99	300
5/16"	SALCSP3Z99	SALCSR3Z99	300
3/8"	SALCSP3999	SALCSR3999	300
7/16"	SALCSP3899	SALCSR3899	300
1/2"	SALCSP3799	SALCSR3799	300
9/16"	SALCSP3699	SALCSR3699	300
5/8"	SALCSP3599	SALCSR3599	300
3/4"	SALCSP3499	SALCSR3499	300
1"	SALCSP3299N	SALCSR3299N	300
1-1/8"	SALCSP3199N	SALCSR3199N	300
1-1/4"	SALCSP3A99N	SALCSR3A99N	300
1-5/16"	SALCSP3B99N	SALCSR3B99N	300
1-3/8"	SALCSP3C99N	SALCSR3C99N	300
1-7/16"	SALCSP3D99N	SALCSR3D99N	300
1-9/16"	SALCSP3E99N	SALCSR3E99N	300



1



2

Face Frame Hinge Accessories

SALICE

Restriction Clips			
Item #	Description	Box Qty	
1	SALSSP3377G 86° Restriction Clip for 1/4"- 3/4" Overlay "S" Series Hinges	2,000	
2	SALSSP3377AG 86° Restriction Clip for 1-1/8"- 1-9/16" Overlay "S" Series Hinges	2,000	

SALICE SELF-CLOSE FACE FRAME HINGES

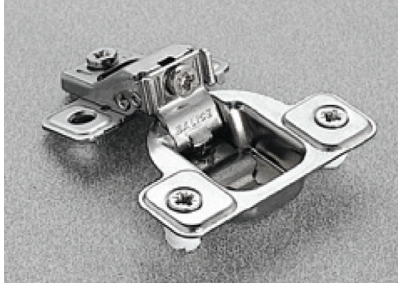

**106° Excentthree 3-Cam Face Frame Hinges
S Series**

SALICE

- 11 mm (7/16") cup depth
- Stamped steel
- Drilling distance fixed at 2.5mm (3/32")

Overlay	Screw-On Item #	Dowel Item #	Box Qty
1/2"	SALCSP3799XR	SALCSR3799XR	300
9/16"	SALCSP3699XR	SALCSR3699XR	300
5/8"	SALCSP3599XR	SALCSR3599XR	300
3/4"	SALCSP3499XR	SALCSR3499XR	300
1"	SALCSP3299NR	SALCSR3299NR	300
1-1/4"	SALCSP3A99NR	SALCSR3A99NR	300
1-5/16"	SALCSP3B99NR	SALCSR3B99NR	300
1-3/8"	SALCSP3C99NR	SALCSR3C99NR	300
1-7/16"	SALCSP3D99NR	SALCSR3D99NR	300
1-9/16"	SALCSP3E99NR	SALCSR3E99NR	300

A
B
C
D
E
F
G
H
I
J
K
L
M
N
O
P
Q
R
S
T
U
V
W
X
Y



1



2

Face Frame Hinge Accessories

SALICE

Restriction Clips			
Item #	Item #	Description	Box Qty
1	SALSSP3377G	86° Restriction Clip for 1/4"- 3/4" Overlay "S" Series Hinges	2,000
2	SALSSP3377AG	86° Restriction Clip for 1-1/8"- 1-9/16" Overlay "S" Series Hinges	2,000

A SUGATSUNE 304B STAINLESS STEEL HINGES

B
C
D
E
F
G
H
I
J
K
L
M
N
O
P
Q
R
S
T
U
V
W
X
Y

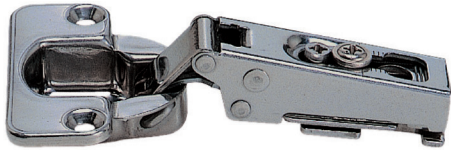

304B 100° Hinges

- Cup diameter 35mm / Cup depth 11mm
- Made of 304 stainless steel for superior corrosion resistance
- Finish: Polished



Item #	Type	Boring Pattern	Fixing	Close Type	Box Qty
SG304B-46/19	3/4" (19mm) Full Overlay	43mm	Screw-On	Free Swinging	200
SG304B-C46/19	3/4" (19mm) Full Overlay	43mm	Screw-On	Self-Closing	200
SG304B-C46/14	9/16" (14mm) Overlay	43mm	Screw-On	Self-Closing	200
SG304B-C46/9	3/8" (9mm) Half Overlay	43mm	Screw-On	Self-Closing	200

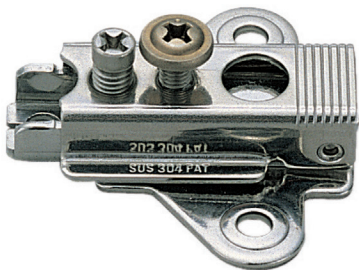

304B Mounting Plate

- Designed for Sugatsune's 304B hinges
- 32mm c/c
- Made of 304 stainless steel for superior corrosion resistance
- Finish: Polished



Item #	Fixing	Box Qty
SG304B-P4A/32	Screw-On	400

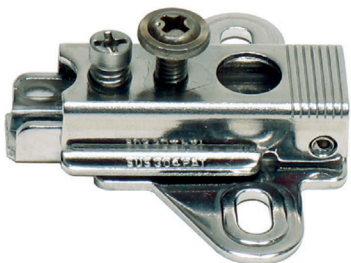

304B Mounting Plate w/Adjustment

- Designed for Sugatsune's 304B hinges
- 32mm c/c
- Oblong holes allow for 4mm adjustment
- Made of 304 stainless steel for superior corrosion resistance
- Finish: Polished



Item #	Fixing	Box Qty
SG304B-P4A/32-3W	Screw-On	400