

SECTION J - TABLE OF CONTENTS

Section J Contents:

PRO LED Tape Lights	2-9
PRO LED Stick Lights.....	10-11
PRO LED Puck Lights.....	12-13
PRO Power Supplies, PRO Switches & Accessories	14-15
Tresco LED RGB-CCT Tape Lights	16-24
Tresco Cabinet Sized LED Kits.....	25-30
Tresco Infinex.....	31-34
Tresco LED Tape Lights	35-39
Tresco LED Linear Lights	40-42
Tresco LED Puck Lights.....	43-46
Tresco Power Supplies.....	47-51
Tresco Accessories	52-64
Tresco Snap LED Panels.....	65
Tresco LED 120 Volt Puck Lights.....	66
Tresco Countertop Displays.....	67
Puck Light Jig.....	68



A
B
C
D
E
F
G
H
I
J
K
L
M
N
O
P
Q
R
S
T
U
V
W
X
Y



A PRO 0.8W LED TAPE

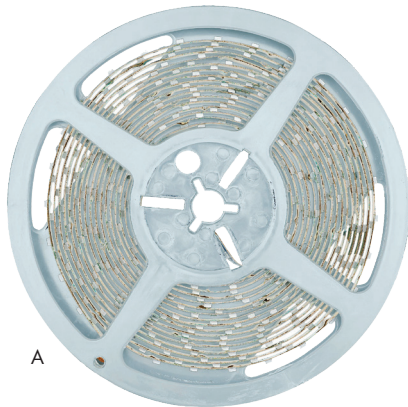

PRO 0.8W LED Tape

- 0.8 Watt per 12", 12 V, Bulb Life: 25,000 hrs.
- 100° Beam Spread, 1 Year Warranty
- Size: 16.4' L x 3/8" W x 5/64" H (can be cut every 4")
- **Required Component:** 79" Lead Cord - sold separately below (B)
- **Required Component:** Dimmable Driver - If you are dimming from a wall dimmer sold separately below (C) **-OR-**
- **Required Component:** Power Supply - If you are **NOT** dimming from a wall dimmer sold separately on next page (F)



	Item #	Description
A	PROPT08W-3R	Pro 0.8W LED Tape, 16.4' Roll, 12 Volts, Warm White (3000K)
	PROPT08W-5R	Pro 0.8W LED Tape, 16.4' Roll, 12 Volts, Cool White (5000K)
⚡ Required Component - Must purchase to get power to PRO 0.8W LED Tape		
B	PROPTPCL-79IN	79" Lead Cord, Connects Tape to Power Supply



Required Component - If you are dimming from a wall dimmer.

Note: Must purchase Hardwire Power Supply with Wall Dimmer Switches.

Used to dim LED Tape with a Wall Dimmer.
Hardwire directly to a wall dimmer switch.

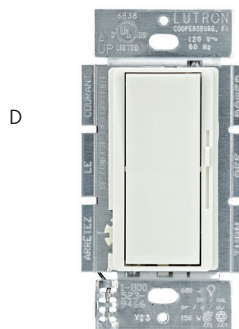

	Item #	Description	Tape Capacity
⚡ Required Component - If you are dimming from a wall dimmer			
C	RVDCE30D-CON	30W, 12V Dim Driver w/6 AMP Ports	37.5'
	RVDCE60D-CON	60W, 12V Dim Driver w/6 AMP Ports	75'
LED Wall Dimmer Switches			
D	PROPRODIAWH	150W, Lutron Diva® C•L™ Dimmer w/out plate	
E	PROPROSKYWH	150W, Lutron Skylark Contour C•L™ Dim w/out plate	

PRO 0.8W LED TAPE



Required Component

If you are **not** dimming from a wall dimmer

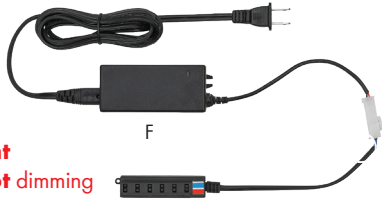

Dimmer Switches

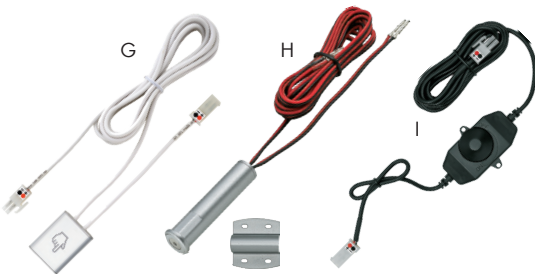

On/Off Switches

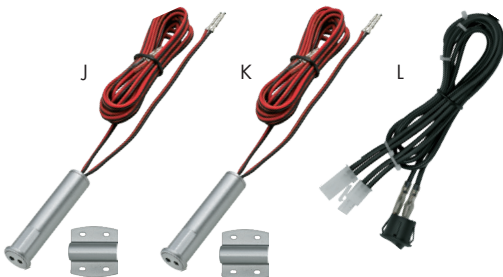

Accessories

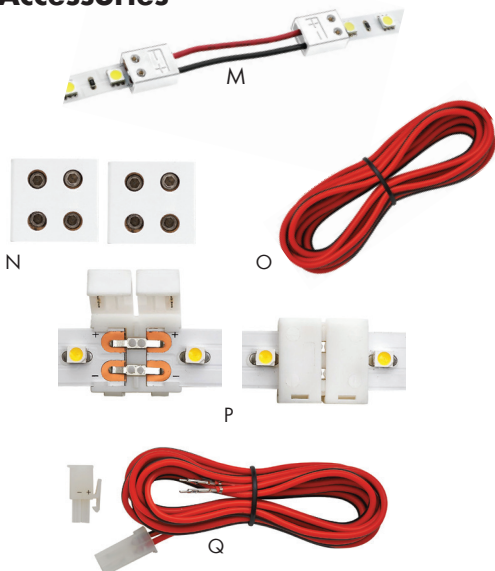

Power Supplies



Item #	Description	Tape Cap.
Required Component - If you are NOT dimming from a wall dimmer		
F	RVDC-EQ30 30W, 12V Power Supply w/6 AMP Ports	37.5'
	RVDC-EQ60 60W, 12V Power Supply w/6 AMP Ports	75'
12V Dimmer Switches (Used with Power Supply)		
G	PROSQRD-NI 60W, Sq. Touch Dimmer w/96" Input - 6" Output Wires	
H	PRORNDTD-NI 60W, Round Touch Dimmer w/79" Input - 6" Output Wires	
I	PROROTDIM-BL 48W, Rotary Dimmer w/79" Input - 8" Output Wires	
12V On/Off Switches (Used with Power Supply)		
J	PRORNDSD-NI 60W, Round Door Sensor w/79" Input - 6" Output Wires	
K	PRORNDPS-NI 60W, Rnd Proximity Switch w/79" Input - 6" Output Wires	
L	PRORNDON-BL 60W, Rnd On/Off Switch w/79" Input - 6" Output Wires	

Accessories

Linking Wires		
M	PROPTCON-2IN	2" Linking Wire, Links Two Tapes Together
	PROPTCON-6IN	6" Linking Wire, Links Two Tapes Together
	PROPTCON-10IN	10" Linking Wire, Links Two Tapes Together
	PROPTCON-24IN	24" Linking Wire, Links Two Tapes Together
	PROPTCON-48IN	48" Linking Wire, Links Two Tapes Together
	PROPTCON-72IN	72" Linking Wire, Links Two Tapes Together
Connectors for Creating Custom Lengths of Linking Wire		
N	PROPTCIC-WH	Custom Interlink Connectors (CIC), Used to Create Custom Lengths of Linking Wire, Packed in Pairs
O	PROPWIRE25-RB	25' Roll, 18 Gauge Wire, Red/Black Color
End-To-End Connector		
P	PROPTBTB-WH	End-To-End Connector
Extension Cords		
Q	PROEXTCON-3IN	3" Extension Cord
	PROEXTCON-6IN	6" Extension Cord
	PROEXTCON-10IN	10" Extension Cord
	PROEXTCON-24IN	24" Extension Cord
	PROEXTCON-48IN	48" Extension Cord
	PROEXTCON-72IN	72" Extension Cord
	PROEXTCON-96IN	96" Extension Cord

A
B
C
D
E
F
G
H
I
J
K
L
M
N
O
P
Q
R
S
T
U
V
W
X
Y

A PRO 1.5W LED TAPE

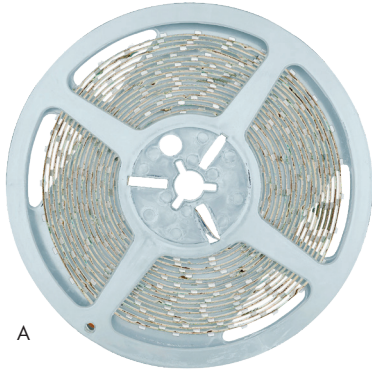

PRO 1.5W LED Tape

- 1.5 Watts per 12", 12 V, Bulb Life: 25,000 hours
- 100° Beam Spread, 1 Year Warranty
- Size: 16.4'L x 3/8"W x 5/64"H (can be cut every 2")
- **Required Component:** 79" Lead Cord - sold separately below (B)
- **Required Component:** Dimmable Driver - If you are dimming from a wall dimmer - sold separately below (C) **-OR-**
- **Required Component:** Power Supply - If you are **NOT** dimming from a wall dimmer - sold separately on next page (F)

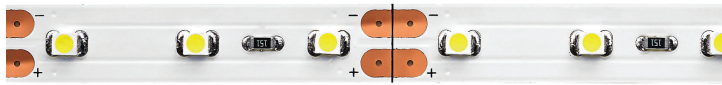

Item #	Description
A	PROPT15W-3R Pro 1.5W LED Tape, 16.4' Roll, 79" Lead Cord Sold Separately, 12 Volts, Warm White (3000K)
A	PROPT15W-5R Pro 1.5W LED Tape, 16.4' Roll, 79" Lead Cord Sold Separately, 12 Volts, Cool White (5000K)
⚡ Required Component - Must purchase to get power to PRO 1.5W LED Tape	
B	PROPTPCL-79IN 79" Lead Cord, Connects Tape to Power Supply

⚡ Required Component - If you are dimming from a wall dimmer.

Note: Must purchase Hardwire Power Supply with Wall Dimmer Switches.

Used to dim LED Tape with a Wall Dimmer.
Hardwire directly to a wall dimmer switch.

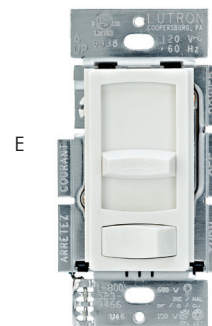
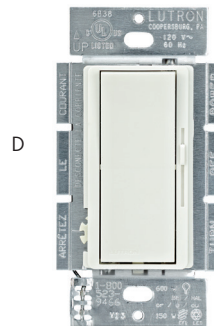

Item #	Description	Tape Capacity
⚡ Required Component - If you are dimming from a wall dimmer		
C	RVDCE30D-CON 30W, 12V Dim Driver w/6 AMP Ports	20'
C	RVDCE60D-CON 60W, 12V Dim Driver w/6 AMP Ports	40'
LED Wall Dimmer Switches		
D	PROPRODIVAWH 150W, Lutron Diva® C • L™ Dimmer w/out plate	
E	PROPROSKYWH 150W, Lutron Skylark Contour C • L™ Dim w/out plate	

PRO 1.5W LED TAPE



Required Component

If you are **not** dimming from a wall dimmer

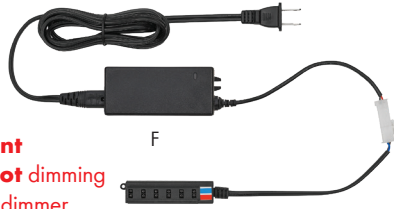

Dimmer Switches

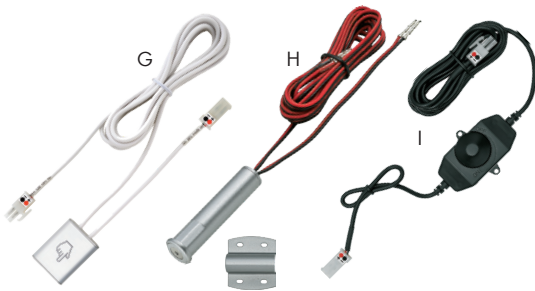

On/Off Switches

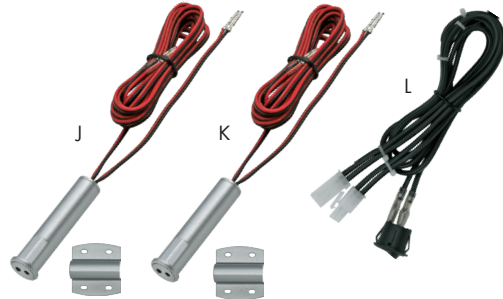

Accessories

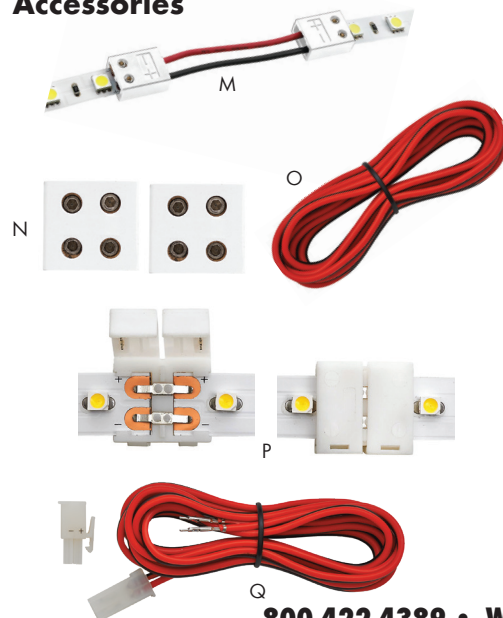

Power Supplies



Item #	Description	Tape Cap.
Required Component - If you are NOT dimming from a wall dimmer		
F	RVDC-EQ30	30W, 12V Power Supply w/6 AMP Ports
	RVDC-EQ60	60W, 12V Power Supply w/6 AMP Ports

12V Dimmer Switches (Used with Power Supply)

G	PROSQRD-NI	60W, Sq. Touch Dimmer w/96" Input - 6" Output Wires
H	PRORNDTD-NI	60W, Round Touch Dimmer w/79" Input - 6" Output Wires
I	PROROTDIM-BL	48W, Rotary Dimmer w/79" Input - 8" Output Wires

12V On/Off Switches (Used with Power Supply)

J	PRORNDSD-NI	60W, Round Door Sensor w/79" Input - 6" Output Wires
K	PRORNDPS-NI	60W, Round Proximity Switch w/79" Input - 6" Output Wires
L	PRORNDON-BL	60W, Round On/Off Switch w/79" Input - 6" Output Wires

Accessories

Linking Wires

M	PROPTCON-2IN	2" Linking Wire, Links Two Tapes Together
	PROPTCON-6IN	6" Linking Wire, Links Two Tapes Together
	PROPTCON-10IN	10" Linking Wire, Links Two Tapes Together
	PROPTCON-24IN	24" Linking Wire, Links Two Tapes Together
	PROPTCON-48IN	48" Linking Wire, Links Two Tapes Together
	PROPTCON-72IN	72" Linking Wire, Links Two Tapes Together

Connectors for Creating Custom Lengths of Linking Wire

N	PROPTCIC-WH	Custom Interlink Connectors (CIC), Used to Create Custom Lengths of Linking Wire, Packed in Pairs
O	PROPWIRE25-RB	25' Roll, 18 Gauge Wire, Red/Black Color

End-To-End Connector

P	PROPTBTB-WH	End-To-End Connector
---	-------------	----------------------

Extension Cords

Q	PROEXTCON-3IN	3" Extension Cord
	PROEXTCON-6IN	6" Extension Cord
	PROEXTCON-10IN	10" Extension Cord
	PROEXTCON-24IN	24" Extension Cord
	PROEXTCON-48IN	48" Extension Cord
	PROEXTCON-72IN	72" Extension Cord
	PROEXTCON-96IN	96" Extension Cord



A PRO 3W LED TAPE

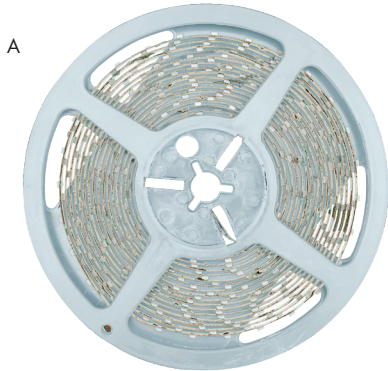

PRO 3W LED Tape

- 3 Watts per 12", 12 Volts, Bulb Life: 25,000 hours
- 100° Beam Spread, 1 Year Warranty
- Size: 16.4'L x 3/8"W x 5/64"H (can be cut every 1")
- **Required Component:** 79" Lead Cord - sold separately below (B)
- **Required Component:** Dimmable Driver - If you are dimming from a wall dimmer - sold separately below (C) **-OR-**
- **Required Component:** Power Supply - If you are **NOT** dimming from a wall dimmer - sold separately on next page (F)



Item #	Description
A	PROPT3W-3R PRO 3W LED Tape, 16.4' Roll, 79" Lead Cord Sold Separately, 12 Volts, Warm White (3000K)
A	PROPT3W-5R PRO 3W LED Tape, 16.4' Roll, 79" Lead Cord Sold Separately, 12 Volts, Cool White (5000K)
⚡ Required Component - Must purchase to get power to PRO 3W LED Tape	
B	PROPTPCL-79IN 79" Lead Cord, Connects Tape to Power Supply

⚡ Required Component - If you are dimming from a wall dimmer.
 NOTE: Must purchase Hardwire Power Supply with Wall Dimmer Switches.

Used to dim LED Tape with a Wall Dimmer.
 Hardwire directly to a wall dimmer switch.

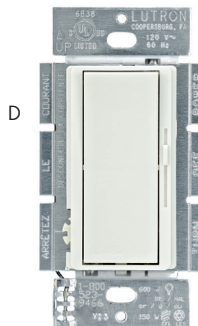

Item #	Description	Tape Capacity
⚡ Required Component - If you are dimming from a wall dimmer		
C	RVDCE30D-CON 30W, 12V Dim Driver w/6 AMP Ports	10'
C	RVDCE60D-CON 60W, 12V Dim Driver w/6 AMP Ports	20'
LED Wall Dimmer Switches		
D	PROPRODIVAWH 150W, Lutron Diva® C • L™ Dimmer w/out plate	
E	PROPROSKYWH 150W, Lutron Skylark Contour C • L™ Dim w/out plate	

PRO 3W LED TAPE



Required Component

If you are **not** dimming from a wall dimmer

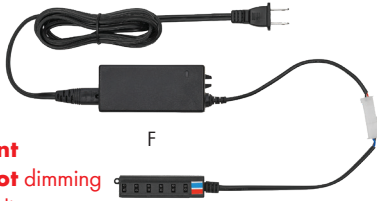

Dimmer Switches

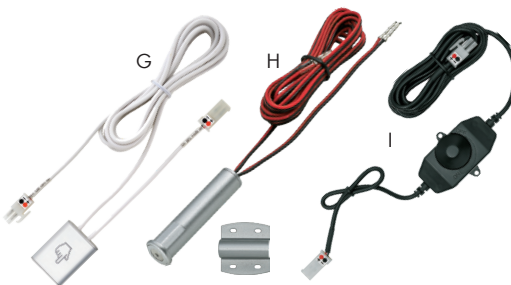

On/Off Switches

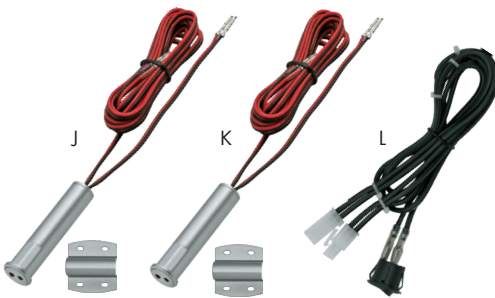

Accessories

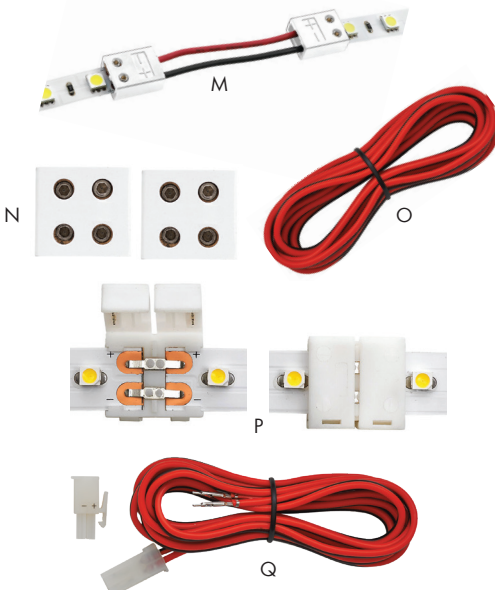

Power Supplies



Item #	Description	Tape Cap.	
Required Component - If you are NOT dimming from a wall dimmer			
F	RVDC-EQ30	30W, 12V Power Supply w/6 AMP Ports	10'
	RVDC-EQ60	60W, 12V Power Supply w/6 AMP Ports	20'
12V Dimmer Switches (Used with Power Supply)			
G	PROSQRTD-NI	60W, Sq. Touch Dimmer w/96" Input - 6" Output Wires	
H	PRORNDTD-NI	60W, Round Touch Dimmer w/79" Input - 6" Output Wires	
I	PROROTDIM-BL	48W, Rotary Dimmer w/79" Input - 8" Output Wires	
12V On/Off Switches (Used with Power Supply)			
J	PRORNDDS-NI	60W, Round Door Sensor w/79" Input - 6" Output Wires	
K	PRORNDPS-NI	60W, Rnd Proximity Switch w/79" Input - 6" Output Wires	
L	PRORNDON-BL	60W, Rnd On/Off Switch w/79" Input - 6" Output Wires	

Accessories

Linking Wires			
M	PROPTCON-2IN	2" Linking Wire, Links Two Tapes Together	
	PROPTCON-6IN	6" Linking Wire, Links Two Tapes Together	
	PROPTCON-10IN	10" Linking Wire, Links Two Tapes Together	
	PROPTCON-24IN	24" Linking Wire, Links Two Tapes Together	
	PROPTCON-48IN	48" Linking Wire, Links Two Tapes Together	
	PROPTCON-72IN	72" Linking Wire, Links Two Tapes Together	
Connectors for Creating Custom Lengths of Linking Wire			
N	PROPTCIC-WH	Custom Interlink Connectors (CIC), Used to Create Custom Lengths of Linking Wire, Packed in Pairs	
O	PROPWIRE25-RB	25' Roll, 18 Gauge Wire, Red/Black Color	
End-To-End Connector			
P	PROPTBTB-WH	End-To-End Connector	
Extension Cords			
Q	PROEXTCON-3IN	3" Extension Cord	
	PROEXTCON-6IN	6" Extension Cord	
	PROEXTCON-10IN	10" Extension Cord	
	PROEXTCON-24IN	24" Extension Cord	
	PROEXTCON-48IN	48" Extension Cord	
	PROEXTCON-72IN	72" Extension Cord	
	PROEXTCON-96IN	96" Extension Cord	

A
B
C
D
E
F
G
H
I
J
K
L
M
N
O
P
Q
R
S
T
U
V
W
X
Y

A PRO 1.5W LED SPLASH PROOF TAPE

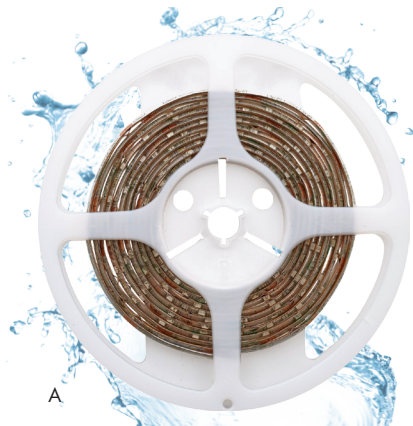

PRO 1.5W LED Splash Proof Tape

- 1.5 Watts per 12", 12 Volts, Bulb Life: 25,000 hours
- 100° Beam Spread, 1 Year Warranty
- Size: 16.4'L x 3/8"W x 5/64"H (can be cut every 2")
- **Required Component:** 79" Lead Cord - sold separately below (B)
- **Required Component:** Dimmable Driver - If you are dimming from a wall dimmer - sold separately below (C) **-OR-**
- **Required Component:** Power Supply - If you are **NOT** dimming from a wall dimmer - sold separately on next page (F)



PRO 1.5W LED Splash Proof Tape Accessories listed on following page

Item #	Description
A	PROPT15W-SP-3R Splash Proof Tape (Clear Plastic Covering over the Tape), 16.4' Roll, 12 Volts, Warm White (3000K)
A	PROPT15W-SP-5R Splash Proof Tape (Clear Plastic Covering over the Tape), 16.4' Roll, 12 Volts, Cool White (5000K)
⚠ Required Component - Must purchase to get power to PRO 1.5W LED Splash Proof Tape	
B	PROPTPCL-79IN 79" Lead Cord, Connects Tape to Power Supply

⚠ Required Component - If you are dimming from a wall dimmer.
 Note: Must purchase Hardwire Power Supply with Wall Dimmer Switches.

Used to dim LED Tape with a Wall Dimmer. Hardwire directly to a wall dimmer switch.

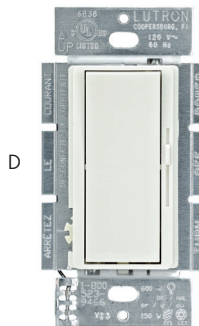

Item #	Description	Tape Capacity
⚠ Required Component - If you are dimming from a wall dimmer		
C	RVDCE30D-CON 30W, 12V Dim Driver w/6 AMP Ports	20'
C	RVDCE60D-CON 60W, 12V Dim Driver w/6 AMP Ports	40'
LED Wall Dimmer Switches		
D	PROPRODIAWH 150W, Lutron Diva® C•L™ Dimmer w/out plate	
E	PROPROSKYWH 150W, Lutron Skylark Contour C•L™ Dim w/out plate	

PRO 1.5W LED SPLASH PROOF TAPE



Required Component
If you are **not** dimming from a wall dimmer

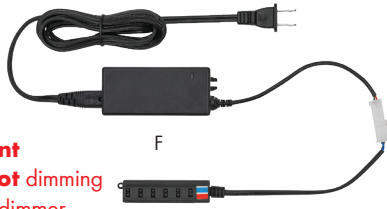

Power Supplies



Item #	Description	Tape Cap.
Required Component - If you are NOT dimming from a wall dimmer		
F	RVDC-EQ30	30W, 12V Power Supply w/6 AMP Ports
	RVDC-EQ60	60W, 12V Power Supply w/6 AMP Ports

Dimmer Switches

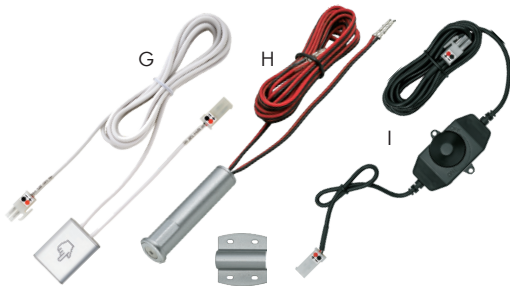

12V Dimmer Switches (Used with Power Supply)		
G	PROSQRTD-NI	60W, Sq. Touch Dimmer w/96" Input - 6" Output Wires
H	PRORNDTD-NI	60W, Round Touch Dimmer w/79" Input - 6" Output Wires
I	PROROTDIM-BL	48W, Rotary Dimmer w/79" Input - 8" Output Wires

On/Off Switches

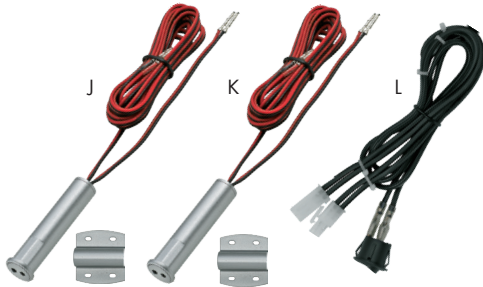

12V On/Off Switches (Used with Power Supply)		
J	PRORNDSDS-NI	60W, Round Door Sensor w/79" Input - 6" Output Wires
K	PRORNDPS-NI	60W, Rnd Proximity Switch w/79" Input - 6" Output Wires
L	PRORNDON-BL	60W, Rnd On/Off Switch w/79" Input - 6" Output Wires

Accessories

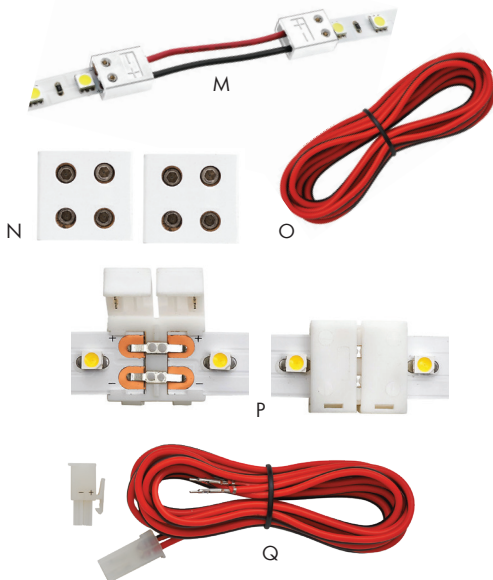

Accessories

Linking Wires		
M	PROPTCON-2IN	2" Linking Wire, Links Two Tapes Together
	PROPTCON-6IN	6" Linking Wire, Links Two Tapes Together
	PROPTCON-10IN	10" Linking Wire, Links Two Tapes Together
	PROPTCON-24IN	24" Linking Wire, Links Two Tapes Together
	PROPTCON-48IN	48" Linking Wire, Links Two Tapes Together
	PROPTCON-72IN	72" Linking Wire, Links Two Tapes Together

Connectors for Creating Custom Lengths of Linking Wire		
N	PROPTCIC-WH	Custom Interlink Connectors (CIC), Used to Create Custom Lengths of Linking Wire, Packed in Pairs
O	PROPWIRE25-RB	25' Roll, 18 Gauge Wire, Red/Black Color

End-To-End Connector		
P	PROPTBTB-WH	End-To-End Connector

Extension Cords		
Q	PROEXTCON-3IN	3" Extension Cord
	PROEXTCON-6IN	6" Extension Cord
	PROEXTCON-10IN	10" Extension Cord
	PROEXTCON-24IN	24" Extension Cord
	PROEXTCON-48IN	48" Extension Cord
	PROEXTCON-72IN	72" Extension Cord
	PROEXTCON-96IN	96" Extension Cord

A
B
C
D
E
F
G
H
I
J
K
L
M
N
O
P
Q
R
S
T
U
V
W
X
Y

PRO 1.5W LED STICK

PRO 1.5W LED Stick

- 1.5 Watts, 12 Volts, Bulb Life: 25,000 Hours
- Each 1.5W LED Stick includes a 79" Lead Cord and Install Brackets
- 90° Beam Spread, 1 Year Warranty

- **Required Component:** Dimmable Driver - If you are dimming from a wall dimmer - sold separately below (B) **-OR-**
- **Required Component:** Power Supply - If you are **NOT** dimming from a wall dimmer - sold separately below (E)



Item #	Description
A	PRO11SK15W-3PL PRO 1.5W LED Stick, 11"L, Includes 79" Lead Cord and Install Brackets, 12 Volts, Warm White (3000K)
	PRO11SK15W-5PL PRO 1.5W LED Stick, 11"L, Includes 79" Lead Cord and Install Brackets, 12 Volts, Cool White (5000K)



Item #	Description	Stick Capacity
Required Component - If you are dimming from a wall dimmer		
B	RVDCE30D-CON 30W, 12V Dim Driver w/6 AMP Ports	20'
	RVDCE60D-CON 60W, 12V Dim Driver w/6 AMP Ports	40'
LED Wall Dimmers used with Dimmable Drivers		
C	PROPRODIAWH 150W, Lutron Diva® C•L™ Dimmer without plate	
D	PROPROSKYWH 150W, Lutron Skylark Contour C•L™ Dim without plate	
Required Component - If you are NOT dimming from a wall dimmer		
E	RVDC-EQ30 30W, 12V Power Supply w/6 AMP Ports	20'
	RVDC-EQ60 60W, 12V Power Supply w/6 AMP Ports	40'
12V Dimmer Switches & On/Off Switches (Used with Power Supplies)		
F	PROSQRTD-NI 60W, Sq. Touch Dimmer w/96" Input - 6" Output Wires	
	PRORNDTD-NI 60W, Round Touch Dimmer w/79" Input - 6" Output Wires	
G	PRORNDPS-NI 60W, Rnd Proximity Switch w/79" Input - 6" Output Wires	
	PRORNDSD-NI 60W, Round Door Sensor w/79" Input - 6" Output Wires	
H	PROROTDIM-BL 48W, Rotary Dimmer w/79" Input - 8" Output Wires	
I	PRORNDON-BL 60W, Rnd On/Off Switch w/79" Input - 6" Output Wires	

Linking Wires (Links 2 Sticks Together)	
Item #	Size
J	PROSKLNK-2IN 2"
	PROSKLNK-6IN 6"
	PROSKLNK-10IN 10"
	PROSKLNK-24IN 24"
	PROSKLNK-48IN 48"
	PROSKLNK-72IN 72"
	PROSKLNK-96IN 96"

Extension Cords	
Item #	Size
K	PROEXTCON-3IN 3"
	PROEXTCON-6IN 6"
	PROEXTCON-10IN 10"
	PROEXTCON-24IN 24"
	PROEXTCON-48IN 48"
	PROEXTCON-72IN 72"
	PROEXTCON-96IN 96"

PRO 3W LED STICK

PRO 3W LED Stick



- 3 Watts, 12 Volts, Bulb Life: 25,000 Hours
- Each 3W LED Stick includes a 79" Lead Cord and Install Brackets
- 90° Beam Spread, 1 Year Warranty
- **Required Component:** Dimmable Driver - If you are dimming from a wall dimmer - sold separately below (B) **-OR-**
- **Required Component:** Power Supply - If you are **NOT** dimming from a wall dimmer - sold separately below (E)



Item #	Description
A	PRO 11SK3W-3PL PRO 3W LED Stick, 11" L, Includes 79" Lead Cord and Install Brackets, 12 Volts, Warm White (3000K)
	PRO 11SK3W-5PL PRO 3W LED Stick, 11" L, Includes 79" Lead Cord and Install Brackets, 12 Volts, Cool White (5000K)

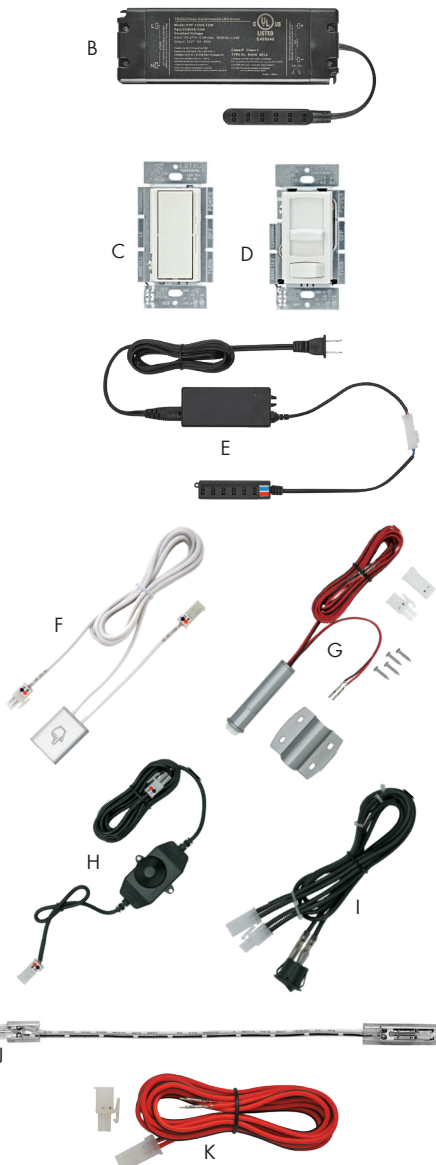

Item #	Description	Stick Capacity
Required Component - If you are dimming from a wall dimmer		
B	RVDCE30D-CON 30W, 12V Dim Driver w/6 AMP Ports	10'
	RVDCE60D-CON 60W, 12V Dim Driver w/6 AMP Ports	20'
LED Wall Dimmers used with Dimmable Drivers		
C	PROPRODIVAWH 150W, Lutron Diva® C•L™ Dimmer without plate	
D	PROPROSKYWH 150W, Lutron Skylark Contour C•L™ Dim without plate	
Required Component - If you are NOT dimming from a wall dimmer		
E	RVDC-EQ30 30W, 12V Power Supply w/6 AMP Ports	10'
	RVDC-EQ60 60W, 12V Power Supply w/6 AMP Ports	20'
12V Dimmer Switches & On/Off Switches (Used with Power Supplies)		
F	PROSQRTD-NI 60W, Sq. Touch Dimmer w/96" Input - 6" Output Wires	
G	PRORNDTD-NI 60W, Round Touch Dimmer w/79" Input - 6" Output Wires	
	PRORNDPS-NI 60W, Rnd Proximity Switch w/79" Input - 6" Output Wires	
	PRORNDSD-NI 60W, Round Door Sensor w/79" Input - 6" Output Wires	
H	PROROTDIM-BL 48W, Rotary Dimmer w/79" Input - 8" Output Wires	
I	PRORNDON-BL 60W, Rnd On/Off Switch w/79" Input - 6" Output Wires	

Linking Wires (Links 2 Sticks Together)	
Item #	Size
J	PROSKLNK-2IN 2"
	PROSKLNK-6IN 6"
	PROSKLNK-10IN 10"
	PROSKLNK-24IN 24"
	PROSKLNK-48IN 48"
	PROSKLNK-72IN 72"
	PROSKLNK-96IN 96"

Extension Cords	
Item #	Size
K	PROEXTCON-3IN 3"
	PROEXTCON-6IN 6"
	PROEXTCON-10IN 10"
	PROEXTCON-24IN 24"
	PROEXTCON-48IN 48"
	PROEXTCON-72IN 72"
	PROEXTCON-96IN 96"

A
B
C
D
E
F
G
H
I
J
K
L
M
N
O
P
Q
R
S
T
U
V
W
X
Y

A
B
C
D
E
F
G
H
I
J
K
L
M
N
O
P
Q
R
S
T
U
V
W
X
Y

PRO 2W LED PUCKS

PRO 2W LED Pucks

- 2 Watts, 12 Volts, Bulb Life: 25,000 hours
- Size: 2-1/4" Diameter Bore Hole x 1/2" Height
- 53° Beam Spread, 1 Year Warranty
- **Required Component:** Dimmable Driver - If dimming from a wall dimmer - sold separately below (B) **-OR-**
- **Required Component:** Power Supply - If you are **NOT** dimming from a wall dimmer - sold separately below (E). Includes attached 79" Connecting Cable



	Black Item #	Nickel Item #	Description
A	PROPK2W-3BL	PROPK2W-3NI	PRO 2W LED Puck w/ 79" cord, 12 Volts, Recess Mount, Warm White (3000K)
	PROPK2W-5BL	PROPK2W-5NI	PRO 2W LED Puck w/ 79" cord, 12 Volts, Recess Mount, Cool White (5000K)

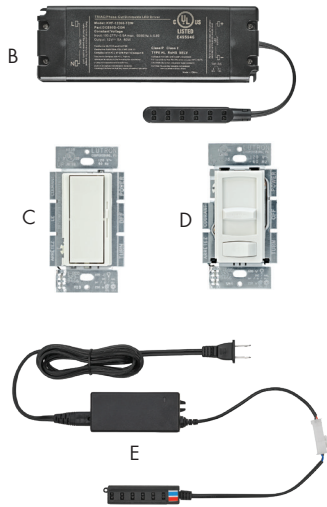

Item #	Description	Stick Capacity
Required Component - If you are dimming from a wall dimmer		
B	RVDCE30D-CON 30W, 12V Dim Driver w/6 AMP Ports	15'
	RVDCE60D-CON 60W, 12V Dim Driver w/6 AMP Ports	30'
LED Wall Dimmers used with Dimmable Drivers		
C	PROPRODIVAWH 150W, Lutron Diva® C•L™ Dimmer without plate	
D	PROPROSKYWH 150W, Lutron Skylark Contour C•L™ Dim without plate	
Required Component - If you are NOT dimming from a wall dimmer		
E	RVDC-EQ30 30W, 12V Power Supply w/6 AMP Ports	15'
	RVDC-EQ60 60W, 12V Power Supply w/6 AMP Ports	30'
12V Dimmer Switches & On/Off Switches (Used with Power Supplies)		
F	PROSQRTD-NI 60W, Sq. Touch Dimmer w/96" Input - 6" Output Wires	
G	PRORNDTD-NI 60W, Round Touch Dimmer w/79" Input - 6" Output Wires	
	PRORNDPS-NI 60W, Rnd Proximity Switch w/79" Input - 6" Output Wires	
	PRORNDDS-NI 60W, Round Door Sensor w/79" Input - 6" Output Wires	
H	PROROTDIM-BL 48W, Rotary Dimmer w/79" Input - 8" Output Wires	
I	PRORNDON-BL 60W, Rnd On/Off Switch w/79" Input - 6" Output Wires	

Surface Mount Ring

	Black Item #	Nickel Item #	Description
J	PROPKSMR-BL	PROPKSMR-NI	PRO LED Puck Surface Mount Ring

Extension Cords

	Item #	Size	Item #	Size
K	PROEXTCON-3IN	3" Extension Cord	PROEXTCON-48IN	48" Extension Cord
	PROEXTCON-6IN	6" Extension Cord	PROEXTCON-72IN	72" Extension Cord
	PROEXTCON-10IN	10" Extension Cord	PROEXTCON-96IN	96" Extension Cord
	PROEXTCON-24IN	24" Extension Cord		

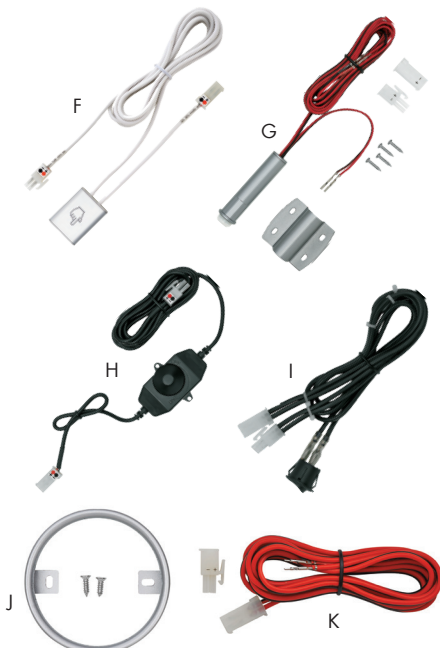

PRO 3W LED PUCKS

PRO 3W LED Pucks

- 3 Watts, 12 Volts, Bulb Life: 25,000 hours
- Size: 2-1/4" Diameter Bore Hole x 7/16" Height
- 100° Beam Spread, 1 Year Warranty
- **Required Component:** Dimmable Driver - If you are dimming from a wall dimmer - sold separately below (C) **-OR-**
- **Required Component:** Power Supply - If you are **NOT** dimming from a wall dimmer - sold separately below (F)

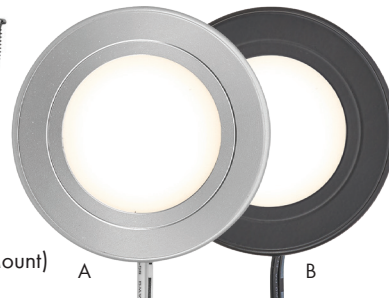

Packing & Sold In: Each (Includes attached 79" Connecting Cable, Frosted Lens, Recess Mount)

Item #	Description
A	PROPK3W-3NI Warm White (3000K), Nickel Finish
	PROPK3W-5NI Cool White (5000K), Nickel Finish

Item #	Description
B	PROPK3W-3BL Warm White (3000K), Black Finish
	PROPK3W-5BL Cool White (5000K), Black Finish

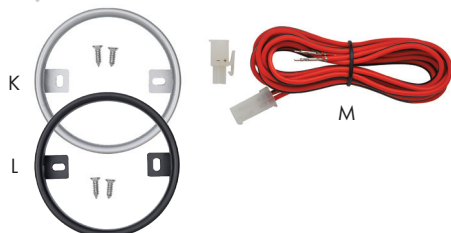
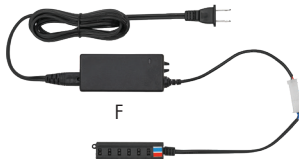
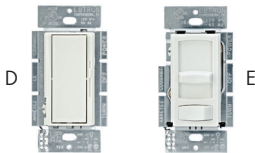

Item #	Description	Stick Capacity
Required Component - If you are dimming from a wall dimmer		
C	RVDC30D-CON 30W, 12V Dim Driver w/6 AMP Ports	10'
	RVDC60D-CON 60W, 12V Dim Driver w/6 AMP Ports	20'
LED Wall Dimmers used with Dimmable Drivers		
D	PROPRODIAVWH 150W, Lutron Diva® C•L™ Dimmer without plate	
E	PROPROSKYWH 150W, Lutron Skylark Contour C•L™ Dim without plate	
Required Component - If you are NOT dimming from a wall dimmer		
F	RVDC-EQ30 30W, 12V Power Supply w/6 AMP Ports	10'
	RVDC-EQ60 60W, 12V Power Supply w/6 AMP Ports	20'
12V Dimmer Switches & On/Off Switches (Used with Power Supplies)		
G	PROSQRTD-NI 60W, Sq. Touch Dimmer w/96" Input - 6" Output Wires	
H	PRORNDTD-NI 60W, Round Touch Dimmer w/79" Input - 6" Output Wires	
	PRORNDPS-NI 60W, Rnd Proximity Switch w/79" Input - 6" Output Wires	
	PRORNDSDS-NI 60W, Round Door Sensor w/79" Input - 6" Output Wires	
I	PROROTDIM-BL 48W, Rotary Dimmer w/79" Input - 8" Output Wires	
J	PRORNDON-BL 60W, Rnd On/Off Switch w/79" Input - 6" Output Wires	

Accessories

Surface Mount Rings	
Item #	Description
K	PROPKSMR-NI Pro LED Puck Surface Mount Ring, Nickel
L	PROPKSMR-BL Pro LED Puck Surface Mount Ring, Black

Extension Cords	
Item #	Description
M	PROEXTCON-3IN 3" Extension Cord
	PROEXTCON-6IN 6" Extension Cord
	PROEXTCON-10IN 10" Extension Cord
	PROEXTCON-24IN 24" Extension Cord
	PROEXTCON-48IN 48" Extension Cord
	PROEXTCON-96IN 96" Extension Cord

A PRO POWER SUPPLIES & SWITCHES

B
C
D
E
F
G
H
I
J
K
L
M
N
O
P
Q
R
S
T
U
V
W
X
Y

Wall Dimmable LED Power Supply

- Dimmable by standard LED wall dimmers
- Electronic units are lower profile and generate less heat than magnetic transformers
- Quiet operation (no humming)
- Works with all PRO 12VDC dimmable LED fixtures
- One 6-Snap Mounting Block included
- High Power Factor (PF >.95)
- RFI protection
- cULus Listed Class 2 with short circuit and automatic reset
- Install Instructions: Input cord is NOT included, remove cover on input side and insert 120V directly into the unit



Compatible PRO Wall Dimmers (see below)

Item #	Description	Size
RVDCE30D-CON	30W Wall Dimmable Hardwire Power Supply with 6 AMP Ports	2-1/8"W x 6-1/8"L x 13/16"H
RVDCE60D-CON	60W Wall Dimmable Hardwire Power Supply with 6 AMP Ports	2-3/8"W x 7"L x 15/16"H

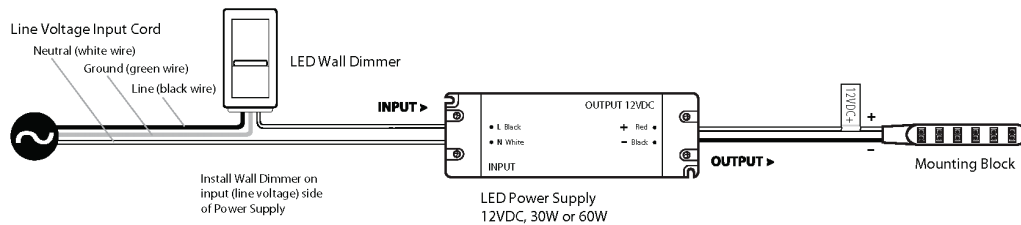

120V LED Wall Dimmers

Lutron Diva® C•L™ Dimmer

- Large paddle switch with a captive linear-slide dimmer for a standard designer wallplate opening
- Preset dimmer
- Offers more reliable dimming performance over standard dimmers
- HED™ technology with advanced dimming circuitry designed for compatibility with most high-efficiency light bulbs
- Low-end adjustment dial
- 150W Capacity

Lutron Skylark Contour C•L™ Dimmer

- On/off rocker switch with a captive linear-slide dimmer for a standard designer wallplate opening
- Switch returns light to preset light level
- Offers more reliable dimming performance over standard dimmers
- HED™ technology with advanced dimming circuitry designed for compatibility with most high-efficiency light bulbs
- Low-end adjustment dial
- 150W Capacity

Lutron Diva® C•L™ Dimmer

Lutron Skylark Contour C•L™ Dimmer



Item #	Description
PROPRODIVAWH	Lutron Diva® C•L™ Dimmer w/out plate
PROPROSKYWWH	Lutron Skylark Contour C•L™ Dimmer w/out plate

PRO POWER SUPPLIES FOR WALL DIMMING APPLICATIONS

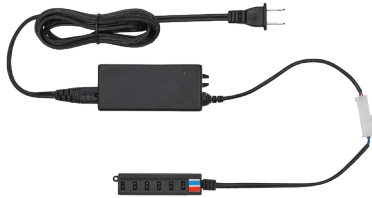

Power Supplies

- Installs by plugging the Power Supply into an outlet
- Dimmable on the trailing edge (12V side), Class 2
- Short circuit protection (automatic reset, no fuses)
- 12V DC output, constant voltage, overcurrent protection, overload protection, RFI protection



Item #	Description
RVDC-EQ30	30 Watts/12 Volts Power Supply, Includes Terminal Block with 6 AMP Ports (Terminal Block has 6" cord) and 72" Plug-In Power Cord, Size of Power Supply: 6-1/8" L X 2-1/8" W X 13/16" H
RVDC-EQ60	60 Watts/12 Volts Power Supply, Includes Terminal Block with 6 AMP Ports (Terminal Block has 6" cord) and 72" Plug-In Power Cord, Size of Power Supply: 7" L X 2-3/8" W X 15/16" H

Round Switches

Nickel Finish

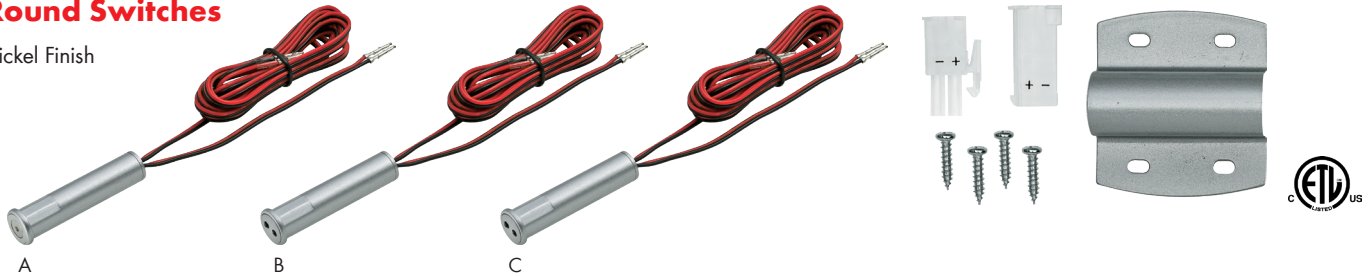

Item #	Description
A PRORNDTD-NI	60W, 12V Round Touch Dimmer w/79" Input - 6" Output Wires, Touch On/Off and 0-100% dimming control, Size: 17/32" Bore Hole Dia. x 2-3/8" L, Includes: Install Bracket and Screws
B PRORNDPS-NI	60W, 12V Round Proximity Switch w/79" Input - 6" Output Wires, Swipe Hand Across (2" Range) to turn On/Off, Size: 17/32" Bore Hole Dia. x 2-3/8" L, Includes: Install Bracket and Screws
C PRORNDSD-NI	60W, 12V Round Door Sensor w/79" Input - 6" Output Wires, Open Door Light is On, Close Door Light is Off (2" Range), Size: 17/32" Bore Hole Dia. x 2-3/8" L, Includes: Install Bracket and Screws

Square Dimmer Switch



Item #	Description
PROSQRTD-NI	60W, 12V Sq. Touch Dimmer with 96" Input / 6" Output Wires, Touch On/Off and 0-100% dimming control Size: 1-9/16" L x 1-1/4" W x 3/8" H, Nickel Finish

Rotary Dimmer Switch



Item #	Description
PROROTDIM-BL	48W, 12V Rotary Dimmer with 79" Input / 8" Output Wires, On/Off and 0-100% dimming control Size: 2-1/2" L x 1-1/4" W x 1-5/8" H, Black Finish

Round On/Off Switch



Black Finish

Item #	Description
PRORNDON-BL	60W, 12V Round On/Off Rocker Switch w/79" Input - 6" Output Wires, Size: 3/4" Dia. Bore Hole x 5/8" Depth

A TRESCO WHITE TUNABLE FLEXTAPE®



2700K



3500K



6500K

Changing your light source's color temperature is easy with Tresco® Lighting's White Tunable CCT FlexTape®. Select between a warmer temperature that highlights natural wood grains and earth tones or cool to highlight whites. Eliminate the guesswork and get the LED that pairs perfectly with your general lighting and overall design.



Features:

- 115-degree beam spread excellent for illuminating cabinets, displays, store fixtures and more
- High output at 345 lumens per ft.
- Cutable and linkable with simple FlexConnect connectors and DIY accessories allowing customization for your project
- Precision tuning from Warm (2700K) to Cool (6500K) with parent controller/receiver (sold separately)
- Dimmable with optional tunable wireless remote or wall dimmer (sold separately)
- Low-profile 300 LSE adhesive 3M™ backing allows versatility to install in a multitude of places
- 5-year commercial-grade warranty



3W/ft.
(9.8W/m)



Dimensions:

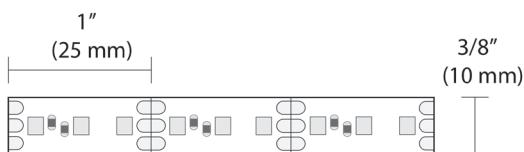
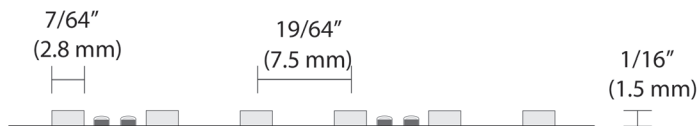

12VDC



12VDC

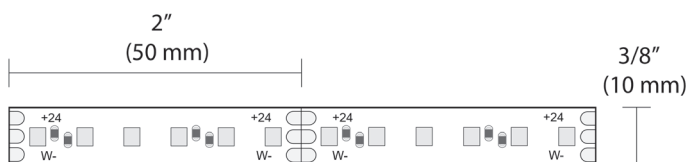

24VDC



24VDC

TRESCO WHITE TUNABLE FLEXTAPE® cont'd

Typical Setup:



RGB CCT Remotes

RGB CCT Remotes

NOTE: Power Supplies on pages J-47 to J-51 and accessories on pages J-22 to J-24

White Tunable (CCT) FlexTape® and Required Components

12/24VDC White Tunable FlexTape®



Item #	Quick Code	Description
RVFLXTPE12CCT	T667	12V, 16.4' Roll, 3W/FT
RVFLXTPE-24CCT	T669	24V, 16.4' Roll, 3W/FT

12/24VDC CCT Starter Cord

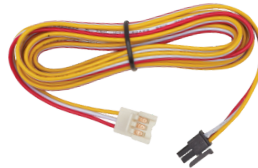

Item #	Quick Code	Desc.
RVTPEPKT2IN-CCT	T711	2" L
RVTPEPKT2M-CCT	T701	79" L

12/24VDC RGB-CCT Parent Receiver

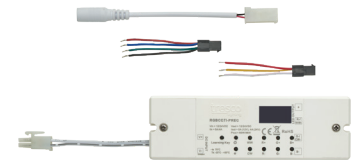

Item #	Quick Code	Desc.
RVRGCCT1-PREC	T673	Parent Receiver

White Tunable (CCT) FlexTape® Optional Components

12/24VDC Starter CCT Extension Leads



Item #	Quick Code	Desc.
RVCCTEXT-60	T659	24" L
RVCCTEXT20	T658	48" L

12/24VDC RGB-CCT Child Receiver



Item #	Quick Code	Desc.
RVRGCCT1-CREC	T672	Child Receiver

12/24VDC CCT Link Cords

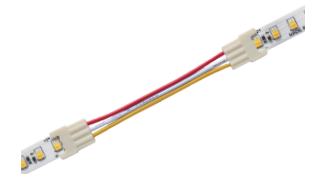

12/24VDC CCT Back-to-Back Connector



Item #	Quick Code
RVTPELNK-BTB	T479

12/24VDC RGB-CCT Remotes



Item #	Quick Code	Description
RVRGCCT-RMT	T674	Wireless Remote
RVWLDCCCT-WH	T703	Deco Wall Dimmer, White

12/24VDC CCT DIY Wire and Terminal Block

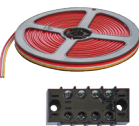

Item #	Quick Code	Desc.
RVCCTWIRE25	T660	25' 20AWG CCT Wire Roll
RVBS4PBL	T657	Barrier Splice 4 Position

Wire and terminal block can be used as a DIY option to create longer extensions.

12/24VDC 6 Output Adaptor



Item #	Quick Code
RV4P6O	T656

Connects to output of parent receiver to control multiple lines of tape.

Item #	Quick Code	Desc.
RVLED-TPELNK-5	T144	2" L
RVTPELNK15-CCT	T691	6" L
RVLED-TPELNK-25	T143	10" L
RVLED-TPELNK-60	T145	24" L
RVLED-TPELNK-120	T140	48" L
RVLED-TPELNK-180	T142	72" L

NOTE: All product dimensions and specifications are subject to change without prior notice.

A TRESCO COB FLEXTAPE®

Chip on Board or "COB" LED tape is the latest advancement in tape lighting. With diodes directly mounted on a printed circuit board and a continuous fortified coating, this flexible, high density LED lighting strip creates our Luniform look without dark spots - no covers or filters needed!



Features:

- New generation of tape lighting with encapsulated diodes to protect from splashes, dust and moisture
- 115° beam angle excellent for illuminating store fixtures, backlighting, edge lighting and more
- Cutable and linkable with our standard FlexTape® link cords, tee connector and 90-degree connector
- Available in 2700K, 3000K, 3500K, 4800K or 6500K
- Low-profile 300 LSE adhesive 3M™ backing allows versatility to install in a multitude of places
- Dimmable with optional controllers (sold separately)
- 5-year commercial-grade warranty



12VDC



4.4W/ft.
(14.5W/m)

245 Lumens per ft.
(809 per meter)



24VDC



5.5W/ft.
(18.1W/m)

420 Lumens per ft.
(1386 per meter)



Dimensions:

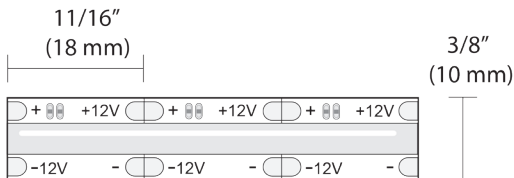

12VDC

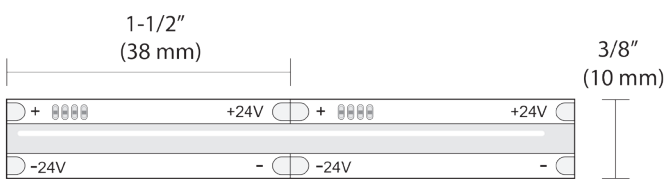

24VDC



Sold by the roll



Strong 300 LSE 3M™ adhesive backing

TRESCO COB FLEXTAPE® cont'd

Typical Setup:

12VDC

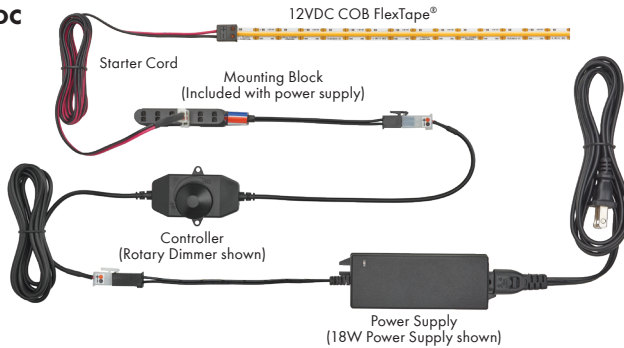

24VDC

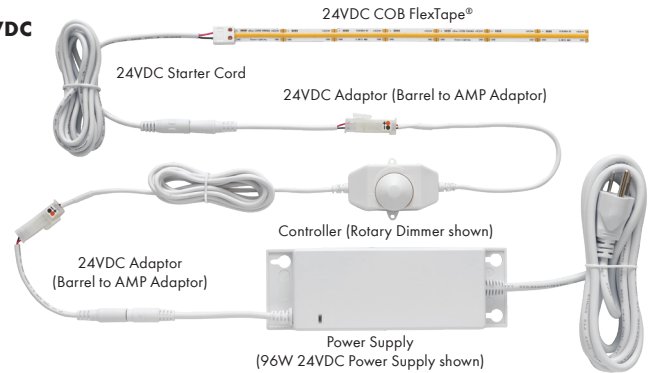

NOTE: Power Supplies on pages J-47 to J-51 and accessories on pages J-22 to J-24

12VDC COB FlexTape® and Required Starter Cord Options

12VDC COB FlexTape® 4.4W



Item #	Quick Code	Description
RVFLXCOB12-27RV	T661	12V, 13' Roll, 2700K, 4.4W/FT
RVFLXCOB12-30RV	T662	12V, 13' Roll, 3000K, 4.4W/FT
RVFLXCOB12-35RV	T716	12V, 13' Roll, 3500K, 4.4W/FT
RVFLXCOB12-48RV	T663	12V, 13' Roll, 4800K, 4.4W/FT
RVFLXCOB12-65RV	T717	12V, 13' Roll, 6500K, 4.4W/FT

12VDC Starter Cord for Single Color Tape



Item #	Quick Code	Description
RVLED-TPEPKT-2M	T147	79" L Starter Cord
RVTPEPKT2IN-CCT	T711	2" L Starter Cord

12VDC Tee Starter Cord for Single Color Tape



Item #	Quick Code	Desc.
RVLED-TPEPKT-2MTEE	T180	79" L Tee Starter Cord

12VDC Extension Lead (Optional)



Item #	Quick Code	Desc.
RVLED-LINKD-8	T351	3" L
RVLED-LINKD-15	T844	6" L
RVLED-LINKD-25	T194	10" L
RVLED-LINKD-60	T195	24" L
RVLED-LINKD-120	T203	48" L
RVLED-LINKD-180	T190	72" L
RVLEDLINKD-245	T447	96" L

COB FlexTape® and Required Starter Cord Options

24VDC COB FlexTape® 5.5W



Item #	Quick Code	Description
RVFLXCOB24-27RU	T664	24V, 16.4' Roll, 2700K, 5.5W/FT
RVFLXCOB24-30RU	T665	24V, 16.4' Roll, 3000K, 5.5W/FT
RVFLXCOB24-35RU	T714	24V, 16.4' Roll, 3500K, 5.5W/FT
RVFLXCOB24-48RU	T666	24V, 16.4' Roll, 4800K, 5.5W/FT
RVFLXCOB24-65RU	T715	24V, 16.4' Roll, 6500K, 5.5W/FT

24VDC Starter Cord for COB



Item #	Quick Code	Description
RV24B2SPKT-2M	T648	79" L Starter Cord

24VDC Tee Starter Cord for COB



Item #	Quick Code	Desc.
RV24B2SPKT2M-TEE1	T649	79" L Tee Starter Cord

24VDC Extension Lead (Optional)



Item #	Quick Code	Description
RV24BBEXTM	T650	39" Barrel Extension Cord
RV24BBEXT-2M	T651	79" Barrel Extension Cord
RV24BBEXT-3M	T652	119" Barrel Extension Cord

12VDC – 24VDC COB FlexTape® Optional Components

12/24VDC Link Cord for Single Color Tape



Item #	Quick Code	Desc.
RVLED-TPELNK-5	T144	2" L
RVLED-TPELNK-15	T141	6" L
RVLED-TPELNK-25	T143	10" L
RVLED-TPELNK-60	T145	24" L
RVLED-TPELNK-120	T140	48" L
RVLED-TPELNK-180	T142	72" L

12/24VDC Tee Connector for Single Color Tape



Item #	Quick Code
RVLED-TPELNK-TEE	T146

12/24VDC Right Angle Connector for Single Color Tape



Item #	Quick Code
RVLEDTPELNK-CON90	T152

12/24VDC Back-to-Back Connector for COB



Item #	Quick Code
RVTPELNK-BTB	T479

NOTE: All product dimensions and specifications are subject to change without prior notice.

A TRESKO RGB TUNABLE FLEXTAPE®

B STANDARD

Creating dramatic lighting with 16 million color combinations is now a reality with RGB Standard color-changing FlexTape®. Created and priced for everyday projects.



C BALANCE

RGB Balance FlexTape® goes the distance with the addition of On-Board Constant Current Regulators. By mitigating voltage drop, the On-Board Constant Current Regulators ensure a balanced color from start to finish. Created for high-end projects including residential, hospitality and commercial.

Features:

- 120-degree beam spread excellent for illuminating cabinets, displays, store fixtures and more
- Cutable and linkable with simple FlexConnect connectors and DIY accessories allowing customization for your project
- Precision tuning of R, G and B with parent controller/receiver (sold separately)
- Dimmable with optional tunable wireless remote or wall dimmer (sold separately)
- Low-profile 300 LSE adhesive 3M™ backing allows versatility to install in a multitude of places
- 5-year commercial-grade warranty



4.4W/ft.
(14.4W/m)

Dimensions:

12VDC Balance



12VDC Balance

24VDC Balance

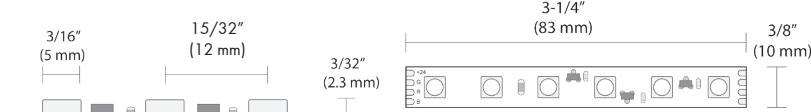

24VDC Balance

24VDC Standard



24VDC Standard

TRESCO RGB TUNABLE COB FLEXTAPE® cont'd

Typical Setup:

12VDC

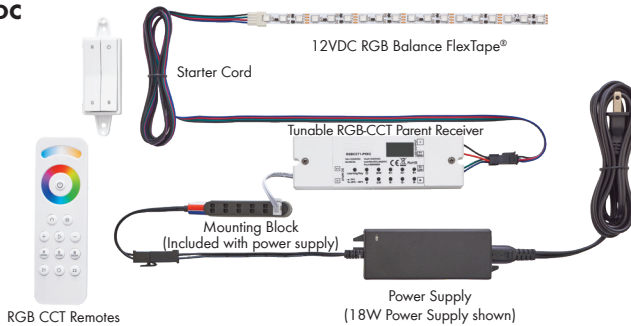

24VDC

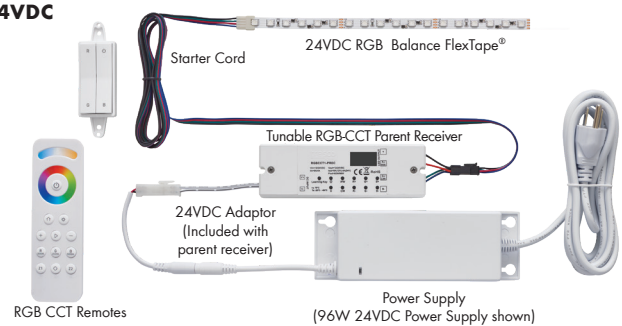

NOTE: Power Supplies on pages J-47 to J-51 and accessories on pages J-22 to J-24

RGB Tunable FlexTape® and Required Components

12/24VDC RGB Balance Tunable FlexTape®



Item #	Quick Code	Description
RVFLXTPE2RGB	T668	12V, 13' Roll, 4.4W/FT
RVFLXTPE-24RGB	T712	24V, 16.4' Roll, 4.4W/FT

24VDC RGB Standard FlexTape®



Item #	Quick Code	Description
RVTPELED-24RGB	T686	24V, 16.4' Roll, 4.4W/FT

12/24VDC RGB Starter Cord

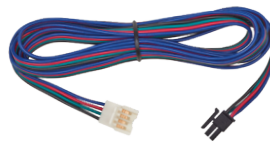

Item #	Quick Code	Desc.
RVTPEPKT2IN-RGB	T713	2" L Starter Cord
RVTPEPKT2M-RGB	T702	79" L Starter Cord

12/24VDC RGB-CCT Parent Receiver

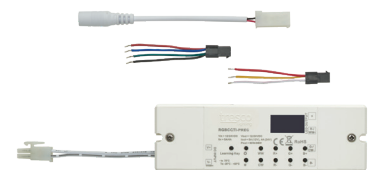

Item #	Quick Code	Description
RVRGBCCT1-PREC	T673	Parent Receiver

RGB Tunable FlexTape® Optional Components

12/24VDC Starter RGB Extension Leads



Item #	Quick Code	Desc.
RVRGBEXT-60	T676	24" L
RVRGBEXT20	T675	48" L

12/24VDC RGB-CCT Child Receiver



Item #	Quick Code	Desc.
RVRGBCCT1-CREC	T672	Child Receiver

12/24VDC RGB Back-to-Back Connector



Item #	Quick Code
RVTPELNK-BTB	T479

12/24VDC RGB DIY Wire and Terminal Block



Item #	Quick Code	Desc.
RVRGBWIRE25	T677	25' 20AWG RGB Wire Roll
RVBS4PBL	T657	Barrier Splice 4 Position

Wire and terminal block can be used as a DIY option to create longer extensions.

12/24VDC RGB-CCT Remotes



Item #	Quick Code	Desc.
RVRGBCCT-RMT	T674	Wireless Remote
RVWLDRGB-WH	T704	Deco Wall Dimmer, White

12/24VDC 6 Output Adaptor



Item #	Quick Code
RV4P6O	T656

Connects to output of parent receiver to control multiple lines of tape.

12/24VDC RGB Link Cords

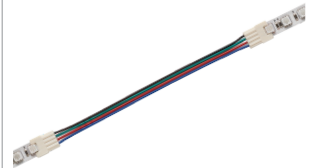

Item #	Quick Code	Desc.
RVTPELNK5-RGB	T698	2" L
RVTPELNK15-RGB	T692	6" L
RVTPELNK25-RGB	T696	10" L
RVTPELNK60-RGB	T700	24" L
RVTPELNK120-RGB	T690	48" L
RVTPELNK180-RGB	T694	72" L

NOTE: All product dimensions and specifications are subject to change without prior notice.

TRESCO 4W CCT POWER POKKIT & RGB-CCT ACCESSORIES



24 Volt 4W CCT Power Pockit

- Aluminum die cast construction w/79" cord and milk lens
- 2-1/4" Bore Hole Dia x 1/2"D
- 105-degree beam spread
- Recess or surface mount
- White Tunable from 2700K-6500K (2700K = 236 lumens / 6500K = 280 lumens)

NOTE: Power Supplies on pages J-47 to J-51 & accessories on pages J-22 to J-24



Black Item #	Quick Code	Color	Description
RVPOC-4CCT24-BL	T900	Black	24V 4W CCT Puck Light
RVPOC-4CCT24-NI	T901	Nickel	24V 4W CCT Puck Light
RVPOC-4CCT24-WH	T902	White	24V 4W CCT Puck Light



A (Parent)



B (Child)

**RGB-CCT Controller/Receivers
12 VOLT / 24 VOLT**



- 60W capacity (12VDC); 96W capacity (24VDC)
- Digital user interface
- Power failure memory
- Simple one-button programming of FREEDiM Series wireless controls
- Compatible Tresco® FREEDiM series RGB or CCT hand and wall controllers (sold separately)
- Works with any 12/24VDC Tresco® RGB or CCT low voltage lights
- Complete with pigtails for RGB or CCT connection
- Tuning of the RGB or Color temperature from 2700K-6500K

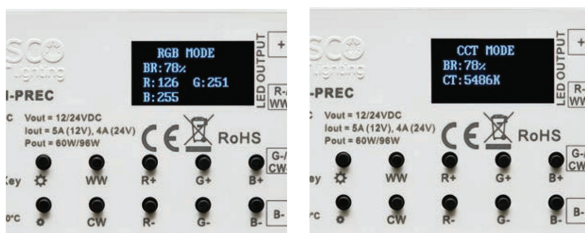

Display in RGB mode. RGB values can be tuned in increments of 1



Display in CCT mode. CCT values can be tuned in increments of 15-16K (Color temperature is range)

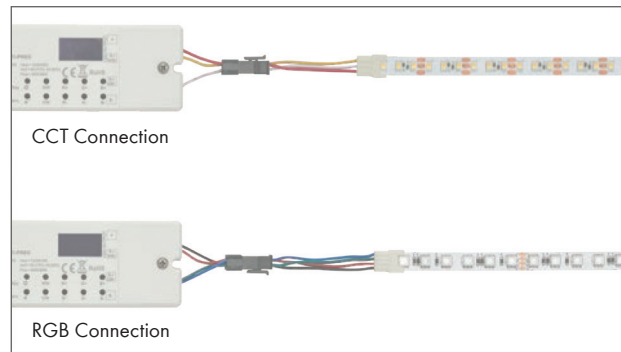

Item #	Quick Code	Description	Size
A	RVRGBCCT1-PREC	T673	12VDC/24VDC RGB-CCT Parent Controller/Receiver
B	RVRGBCCT1-CREC	T672	12VDC/24VDC RGB-CCT Child Controller/Receiver

TRESCO RGB-CCT ACCESSORIES

RGB-CCT Controllers/Receivers Set Up

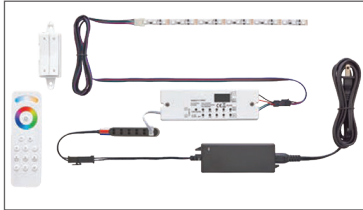

12 Volt Set Up

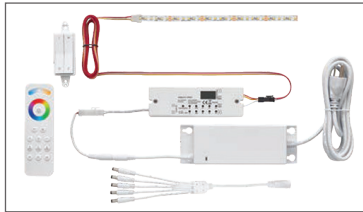

24 Volt Set Up

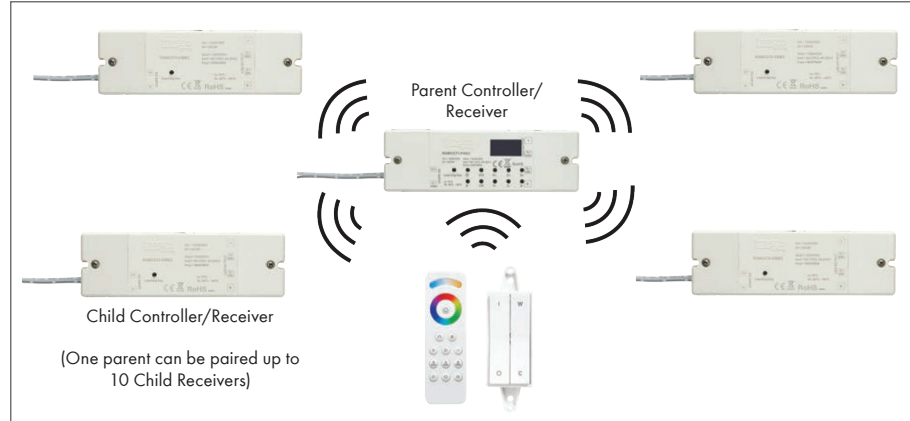

Wireless remote controls 1 parent per zone and 10 child receivers per parent

RGB-CCT Wall Controllers



- (2) configurations: RGB or CCT (White tunable)
- Can be programmed with up to (1) parent and (10) child receivers
- Fits Decora® style wall plates
- 65 ft. (19 m) range of control from dimmer to receiver
- Controls all Tresco RGB or CCT low voltage lights
- RGB/CCT receivers required (sold separately)
- Long-lasting CR1625/1620 battery (included)

CCT – White tunable

- Easy touch warm 2700K to daylight 6500K and on/off/dimming controls

RGB

- Easy touch Red, Green, Blue and on/off/dimming controls

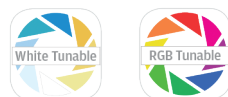

	Item #	Quick Code	Description
A	RVWLDCCCT-WH	T703	CCT FREEDiM Deco Wall Dimmer White
B	RVWLDRGB-WH	T704	RGB FREEDiM Deco Wall Dimmer White

A
B
C
D
E
F
G
H
I
J
K
L
M
N
O
P
Q
R
S
T
U
V
W
X
Y

A TRESCO RGB-CCT ACCESSORIES

B RGB-CCT Wireless Remote

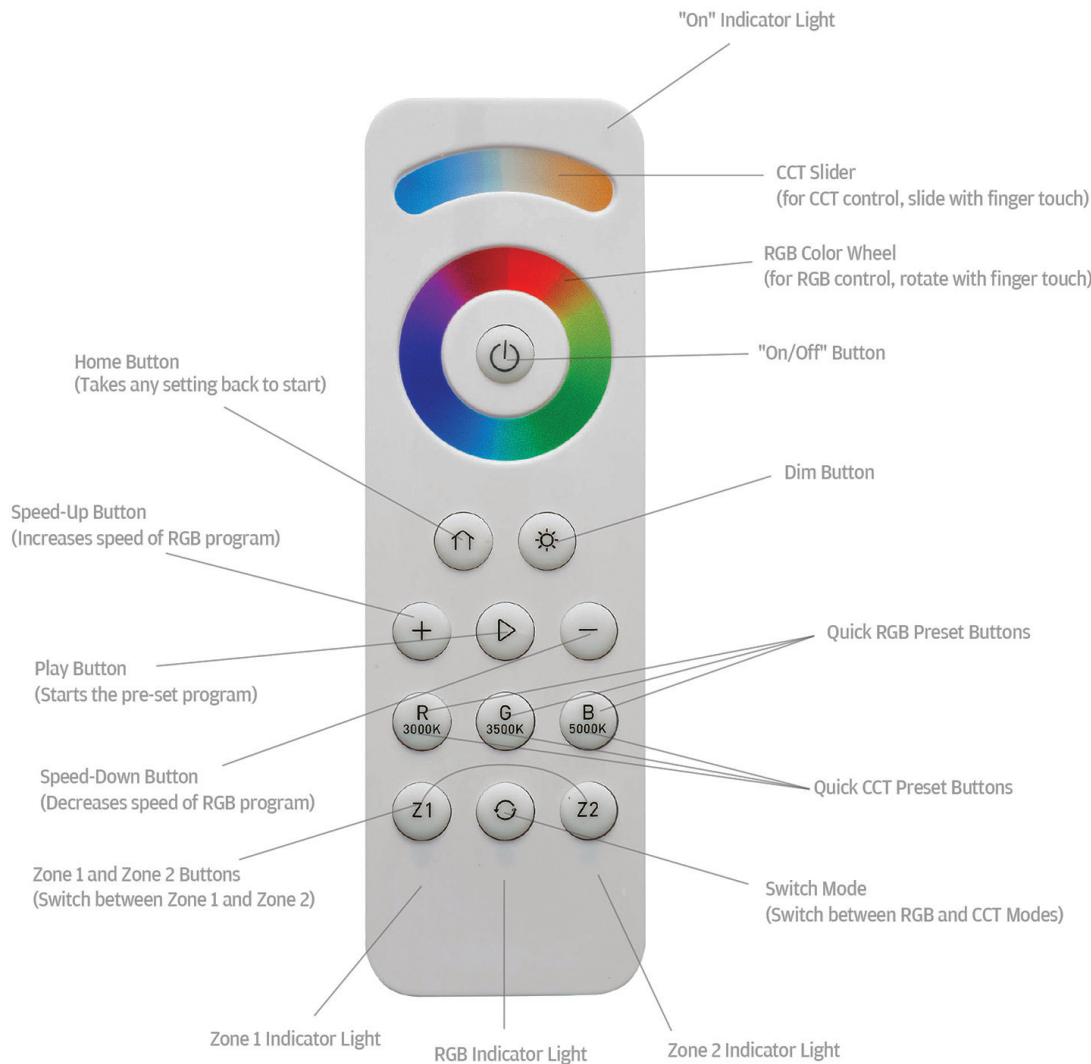

- Intuitive and ergonomic design
- Can control RGB and CCT
- Touch control for color mixing
- Quick set buttons for common CCT and static RGB values
- Program up to (2) separate zones and control independently
- (10) preset RGB sequences with speed control (i.e. fade in, fade out)
- A single remote can control 1 parent and 10 child receivers per zone



Item #	Quick Code	Description	Size
RVRGBCCT-RMT	T674	RGB-CCT Wireless Hand Remote	1-23/32"W x 5-17/32"L

TRESCO CABINET SIZED LED LIGHT KITS

TRESCO'S CABINET SIZED LED LINEAR LIGHT KITS ARE **EASY!**

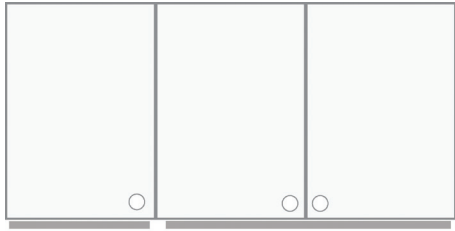

Easy Sizes

Tresco's Cabinet Sized LED Linear Lights are sized specifically to fit your cabinets. One light per cabinet, no more dark spots.



Easy Kits

Tresco Cabinet Sized Light Kits have all the components needed to install. Kits include: (1) Aluminum LED Linear Light w/3" Input & 3" Output Cords, (2) 72" Extension Cords, (2) Mounting Clips, (2) Magnets, and (1) Milk Diffuser.

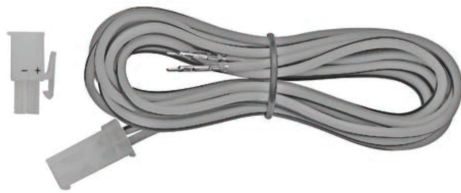

Extra 72" L Extension Wire

An extra wire extension is also included just in case you need it. Installers will never be short of what they need, when they need it.



Easy Packaging

A wall 18" cabinet will use a W18-XXXX light. Installers will immediately know what light goes with what cabinet.



3M VHB™

Easy Mounting

Light kits mount magnetically to metal mounting plates (included) and adhere to the cabinet with 3M VHB tape or you can mount with the included screw-in clips.

A
B
C
D
E
F
G
H
I
J
K
L
M
N
O
P
Q
R
S
T
U
V
W
X
Y

A
B
C
D
E
F
G
H
I
J
K
L
M
N
O
P
Q
R
S
T
U
V
W
X
Y

TRESCO CABINET SIZED LED LIGHT KITS

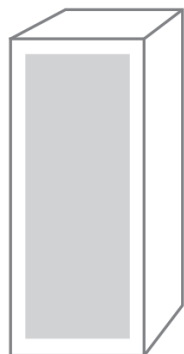

9"W - 18"W Face Frame Wall Cabinets



- Cabinet Sized LED Linear Lights for 9"W - 18"W Face Frame Wall Cabinets
 - Package is labeled with the cabinet size the fixture is designed to fit
 - Maximum Continuous Run: 16 Feet (192")
 - Dimmable by using low voltage dimmer switches and LED Wall Dimmer Switches
 - Bulb Life: 50,000 Hours
 - 12 Volt, Beam Spread: 120°
 - Lumens Per Foot: 150
 - Made of Aluminum (aluminum acts as a heat sink to extend the life of the LEDs)
 - Surface Mounted
- Kit Includes:**
- (1) Aluminum LED Linear Light w/3"Input & 3"Output Cords (Attached)
 - (2) 72" Extension Cords
 - (2) Mounting Clips
 - (2) Magnets
 - (1) Milk Diffuser
- Required Component:** Power Supply
- Optional Associated Items: linkable cords, dimmer switches, and ON/OFF switch available (sold separately)
 - Sold In: Per Kit

Item #	Quick Code	Fits Face Frame Wall Cabinet	Light Length	Watts	Light Fixture Size	Color Temp.	Light Color	Finish
RVW9-XSQRSCN1	T583	9"W	7"L	1.75	7"L x 11/16"W x 1/2"H	3500K	Neutral	Satin Nickel
RVW12-XSQRSCN1	T584	12"W	10"L	2.50	10"L x 11/16"W x 1/2"H	3500K	Neutral	Satin Nickel
RVW15-XSQRSCN1	T585	15"W	13"L	3.25	13"L x 11/16"W x 1/2"H	3500K	Neutral	Satin Nickel
RVW18-XSQRSCN1	T586	18"W	16"L	4.00	16"L x 11/16"W x 1/2"H	3500K	Neutral	Satin Nickel

NOTE: Power Supplies on pages J-47 to J-51 and accessories on pages J-52 to J-64

TRESCO CABINET SIZED LED LIGHT KITS

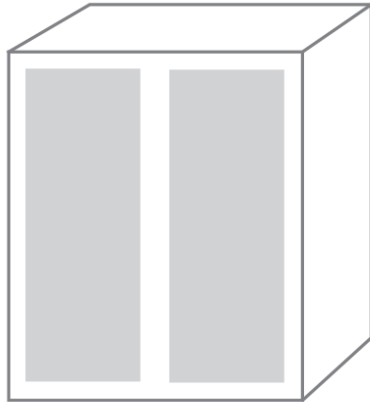

21"W - 48"W Face Frame Wall Cabinets



- Cabinet Sized LED Linear Lights for 21"W - 48"W Face Frame Wall Cabinets
- Package is labeled with the cabinet size the fixture is designed to fit
- Maximum Continuous Run: 16 Feet (192")
- Dimmable by using low voltage dimmer switches and LED Wall Dimmer Switches
- Bulb Life: 50,000 Hours
- 12 Volt, Beam Spread: 120°
- Lumens Per Foot: 150
- Made of Aluminum (aluminum acts as a heat sink to extend the life of the LEDs)
- Surface Mounted

Kit Includes:

- (1) Aluminum LED Linear Light w/3"Input & 3"Output Cords (Attached)
- (2) 72" Extension Cords
- (2) Mounting Clips
- (2) Magnets
- (1) Milk Diffuser

Required Component: Power Supply

- Optional Associated Items: linkable cords, dimmer switches, and ON/OFF switch available (sold separately)
- Sold In: Per Kit

Item #	Quick Code	Fits Face Frame Wall Cabinet	Light Length	Watts	Light Fixture Size	Color Temp.	Light Color	Finish
RVW21-XSQRSCN1	T587	21"W	19"L	4.75	19"L x 11/16"W x 1/2"H	3500K	Neutral	Satin Nickel
RVW24-XSQRSCN1	T588	24"W	22"L	5.50	22"L x 11/16"W x 1/2"H	3500K	Neutral	Satin Nickel
RVW27-XSQRSCN1	T589	27"W	25"L	6.25	25"L x 11/16"W x 1/2"H	3500K	Neutral	Satin Nickel
RVW30-XSQRSCN1	T590	30"W	28"L	7.00	28"L x 11/16"W x 1/2"H	3500K	Neutral	Satin Nickel
RVW33-XSQRSCN1	T591	33"W	31"L	7.75	31"L x 11/16"W x 1/2"H	3500K	Neutral	Satin Nickel
RVW36-XSQRSCN1	T592	36"W	34"L	8.50	34"L x 11/16"W x 1/2"H	3500K	Neutral	Satin Nickel
RVW39-XSQRSCN1	T593	39"W	37"L	9.25	37"L x 11/16"W x 1/2"H	3500K	Neutral	Satin Nickel
RVW42-XSQRSCN1	T594	42"W	40"L	10.00	40"L x 11/16"W x 1/2"H	3500K	Neutral	Satin Nickel
RVW45-XSQRSCN1	T595	45"W	43"L	10.75	43"L x 11/16"W x 1/2"H	3500K	Neutral	Satin Nickel
RVW48-XSQRSCN1	T596	48"W	46"L	11.50	46"L x 11/16"W x 1/2"H	3500K	Neutral	Satin Nickel

NOTE: Power Supplies on pages J-47 to J-51 and accessories on pages J-52 to J-64

A
B
C
D
E
F
G
H
I
J
K
L
M
N
O
P
Q
R
S
T
U
V
W
X
Y

A TRESKO CABINET SIZED LED LIGHT KITS

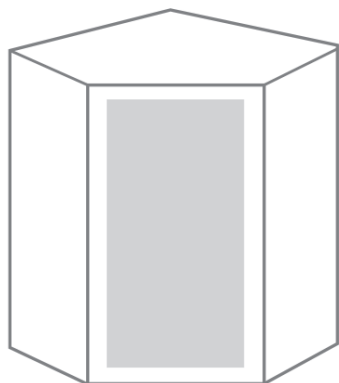

24"W & 27"W Face Frame Wall Angled Corner Cabinets



- Cabinet Sized LED Linear Lights for 24"W & 27"W Face Frame Wall Angled Corner Cabinets
- Package is labeled with the cabinet size the fixture is designed to fit
- Maximum Continuous Run: 16 Feet (192")
- Dimmable by using low voltage dimmer switches and LED Wall Dimmer Switches
- Bulb Life: 50,000 Hours
- 12 Volt, Beam Spread: 120°
- Lumens Per Foot: 150
- Made of Aluminum (aluminum acts as a heat sink to extend the life of the LEDs)
- Surface Mounted

Kit Includes:

- (1) Aluminum LED Linear Light w/3"Input & 3"Output Cords (Attached)
- (2) 72" Extension Cords
- (2) Mounting Clips
- (2) Magnets
- (1) Milk Diffuser

Required Component: Power Supply

- Optional Associated Items: linkable cords, dimmer switches, and ON/OFF switch available (sold separately)
- Sold In: Per Kit

Item #	Quick Code	Fits Face Frame Wall Cabinet	Light Length	Watts	Light Fixture Size	Color Temp.	Light Color	Finish
RVWAC24-XSQRSCN1	T597	24"W	22"L	5.50	22"L x 11/16"W x 1/2"H	3500K	Neutral	Satin Nickel
RVWAC27-XSQRSCN1	T598	27"W	25"L	6.25	25"L x 11/16"W x 1/2"H	3500K	Neutral	Satin Nickel

NOTE: Power Supplies on pages J-47 to J-51 and accessories on pages J-52 to J-64

A
B
C
D
E
F
G
H
I
J
K
L
M
N
O
P
Q
R
S
T
U
V
W
X
Y

TRESCO CABINET SIZED LED LIGHT KITS

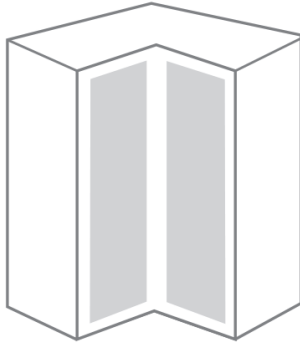

24" W Face Frame Wall Square Corner Cabinet

- Cabinet Sized LED Linear Lights for 24" W Face Frame Wall Square Corner Cabinet
- Package is labeled with the cabinet size the fixture is designed to fit
- Maximum Continuous Run: 16 Feet (192")
- Dimmable by using low voltage dimmer switches and LED Wall Dimmer Switches
- Bulb Life: 50,000 Hours
- 12 Volt, Beam Spread: 120°
- Lumens Per Foot: 150
- Made of Aluminum (aluminum acts as a heat sink to extend the life of the LEDs)
- Surface Mounted

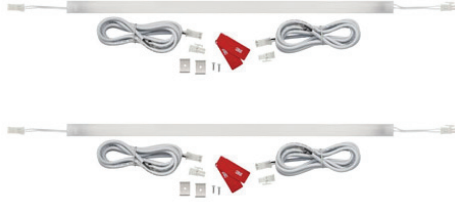

Kit Includes:

- (2) Aluminum LED Linear Light w/3" Input & 3" Output Cords (Attached)
- (4) 72" Extension Cords
- (4) Mounting Clips
- (4) Magnets
- (2) Milk Diffuser

Required Component: Power Supply

- Optional Associated Items: linkable cords, dimmer switches, and ON/OFF switch available (sold separately)
- Sold In: Per Kit

Item #	Quick Code	Fits Face Frame Wall Cabinet	Light Length	Watts	Light Fixture Size	Color Temp.	Light Color	Finish
RVWSC24-XSQRSCN1	T599	24"W	10"L	2.50	10"L x 11/16"W x 1/2"H	3500K	Neutral	Satin Nickel

NOTE: Power Supplies on pages J-47 to J-51 and accessories on pages J-52 to J-64

A
B
C
D
E
F
G
H
I
J
K
L
M
N
O
P
Q
R
S
T
U
V
W
X
Y

A
B
C
D
E
F
G
H
I
J
K
L
M
N
O
P
Q
R
S
T
U
V
W
X
Y

CABINET SIZED LED LIGHT KITS

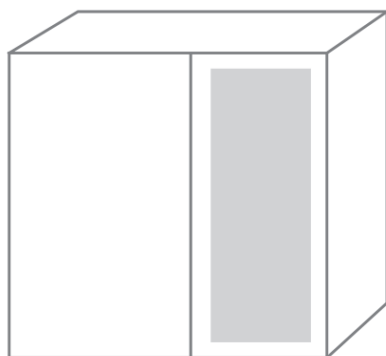

24" W Face Frame Wall Square Blind Corner Cabinet

- Cabinet Sized LED Linear Lights for 24" W - 30" W Face Frame Wall Blind Corner Cabinets
- Package is labeled with the cabinet size the fixture is designed to fit
- Maximum Continuous Run: 16 Feet (192")
- Dimmable by using low voltage dimmer switches and LED Wall Dimmer Switches
- Bulb Life: 50,000 Hours
- 12 Volt, Beam Spread: 120°
- Lumens Per Foot: 150
- Made of Aluminum (aluminum acts as a heat sink to extend the life of the LEDs)
- Surface Mounted



Kit Includes:

- (1) Aluminum LED Linear Light w/3" Input & 3" Output Cords (Attached)
- (2) 72" Extension Cords
- (2) Mounting Clips
- (2) Magnets
- (1) Milk Diffuser

Required Component: Power Supply

- Optional Associated Items: linkable cords, dimmer switches, and ON/OFF switch available (sold separately)
- Sold In: Per Kit

Item #	Quick Code	Fits Face Frame Wall Cabinet	Light Length	Watts	Light Fixture Size	Color Temp.	Light Color	Finish
RWWBC24-XSQRSCN1	T600	24"W	22"L	5.50	22"L x 1 1/16"W x 1/2"H	3500K	Neutral	Satin Nickel
RWWBC27-XSQRSCN1	T601	27"W	25"L	6.25	25"L x 1 1/16"W x 1/2"H	3500K	Neutral	Satin Nickel
RWWBC30-XSQRSCN1	T602	30"W	28"L	7.00	30"L x 1 1/16"W x 1/2"H	3500K	Neutral	Satin Nickel

NOTE: Power Supplies on pages J-47 to J-51 and accessories on pages J-52 to J-64

TRESCO® INFINEX

HOW TO ORDER INFINEX



- 1 CHOOSE YOUR ALUMINUM CHANNEL STYLE & FINISH**
- 2 CHOOSE YOUR DIFFUSERS**
- 3 CHOOSE YOUR LED TAPE**
- 4 CHOOSE YOUR END CAPS & STARTER CORD**
- 5 CUT TO SIZE & ASSEMBLE**
- 6 OPTIONS**

A
B
C
D
E
F
G
H
I
J
K
L
M
N
O
P
Q
R
S
T
U
V
W
X
Y

A
B
C
D
E
F
G
H
I
J
K
L
M
N
O
P
Q
R
S
T
U
V
W
X
Y

TRESCO® INFINEX

1 CHOOSE YOUR ALUMINUM CHANNEL STYLE & FINISH

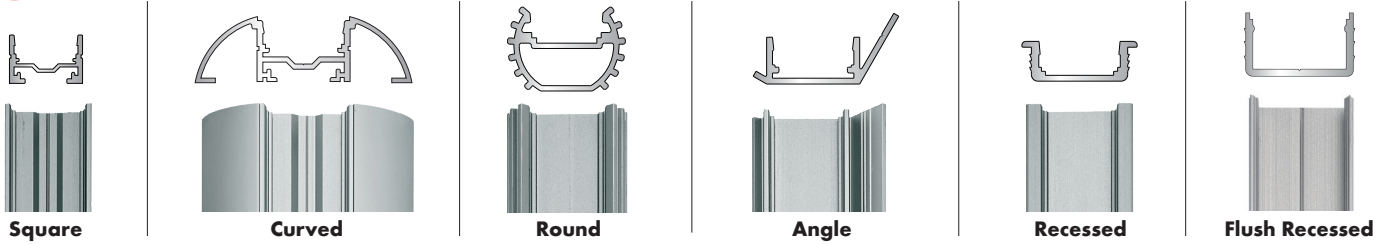

72" (1.8m) Extruded Aluminum Channels

Shape	Clear Aluminum Item #	Quick Code	White Item #	Quick Code	Black Item #	Quick Code
Square	RVXSQR72-SC	T394	RVXSQR72-WH	T552	RVXSQR72-BL	T551
Curved	RVXCRV72-SC	T405	RVXCRV72-WH	T827	RVXCRV72-BL	T828
Round	RVXRND72-SC	T397	-	-	RVXRND72-BL	T829
Angle	RVXANG72-SC	T407	RVXANG72-WH	T830	-	-
Recessed	RVXREC72-SC	T401	-	-	RVXREC72-BL	T582
Flush Recessed (Includes Milk Diffuser)	RVXFL72-SC-10	T546				

94" Extruded Aluminum Channel

Flushed Recessed (Includes Milk Diffuser)	RVXFL96-SC	T547
---	------------	------

2 CHOOSE YOUR DIFFUSERS

Clear Diffuser

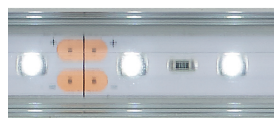

1.5W FlexTape



3W FlexTape



4.4W FlexTape

Frosted Diffuser

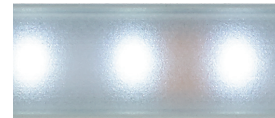

1.5W FlexTape



3W FlexTape



4.4W FlexTape

Milk Diffuser



1.5W FlexTape



3W FlexTape



4.4W FlexTape

Diffusers

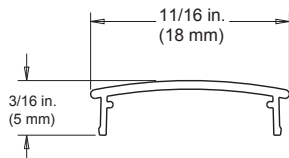

Required Items		
Item #	Quick Code	Description
RVX72-DIFF-CL	T409	72" (1.8 m) Diffuser Clear
RVX72-DIFF-FR	T408	72" (1.8 m) Diffuser Frosted
RVX72-DIFF-MLK	T544	72" (1.8m) Diffuser Milk

TRESCO® INFINEX



3 CHOOSE FLEXTAPE
(See Tape options on pages J-35 - J-39)

4 CHOOSE END CAPS, STARTER CORD & LINKING CORDS

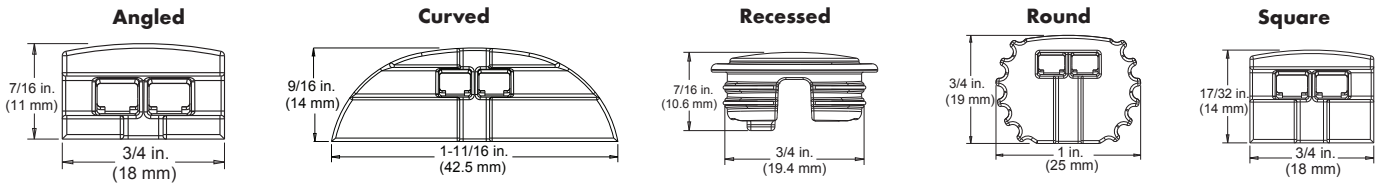

End Caps for Extruded Aluminum Channels						
Shape	Gray Finish Item #	Quick Code	White Finish Item #	Quick Code	Black Finish Item #	Quick Code
Angled	RVXANGECP-GY	T406	RVXANGECP-WH	T831	-	-
Curved	RVXCRVECP-GY	T404	RVXCRVECP-WH	T832	RVXCRVECP-BL	T833
Recessed	RV-XRECECP-GY	T400	-	-	RV-XRECECP-BL	T834
Round	RV-XRNDECP-GY	T396	-	-	RV-XRNDECP-BL	T835
Square	RV-XSQRECP-GY	T393	RVXSQRECP-WH	T554	RV-XSQRECP-BL	T553

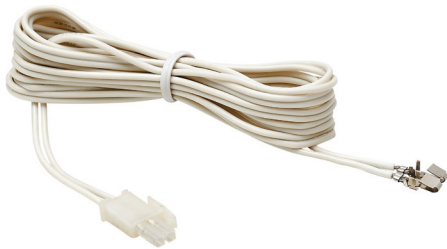

79" (2 m) Starter Cord

Black Finish Item #	Quick Code	White Finish Item #	Quick Code
RVXPKT-2M-BL	T403	RVXPKT-2M-WH	T402



Linking Cords

White Finish Item #	Quick Code	Black Finish Item #	Quick Code	Description
RVXLNK-WH	T484	RVXLNK-BL	T489	15 cm (6") Length
RVXLNK-25-WH	T485	RVXLNK-25-BL	T490	25 cm (10") Length
RVXLNK-60-WH	T486	RVXLNK-60-BL	T491	60 cm (24") Length
RVXLNK-120-WH	T487	RVXLNK-120-BL	T492	120 cm (48") Length
RVXLNK-180-WH	T488	RVXLNK-180-BL	T493	180 cm (72") Length

A
B
C
D
E
F
G
H
I
J
K
L
M
N
O
P
Q
R
S
T
U
V
W
X
Y

A TRESKO® INFINEX

5 CUT TO SIZE & ASSEMBLE

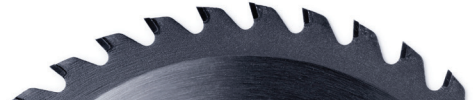

Aluminum extrusions can be cut on a variety of equipment. For the best performance and longest life, use a saw blade designed for non-ferrous, thin stock, on your miter saw. It is also highly recommended to cut extrusion with diffuser securely attached via clamps, tape, stretch wrap etc. to prevent unwanted cracking of diffuser.

6 OPTIONS

U-Clips/Magnets

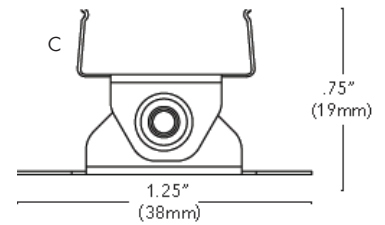
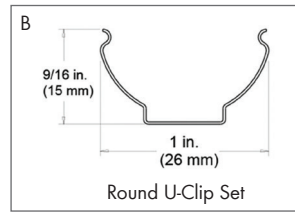
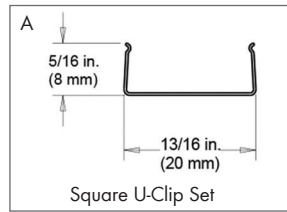

	Item #	Quick Code	Description
A	RVXSQRSWCLP	T555	Square/Curved U-Clips Set (2 Clips)
B	RV-XRND-UCLP	T398	Round U-Clips Set (2 Clips)
C	RV-XSQR-UCLP	T395	Swivel Clips Set (2 Clips)
D	RV-XRM42-155	T399	Set of 2 Magnets

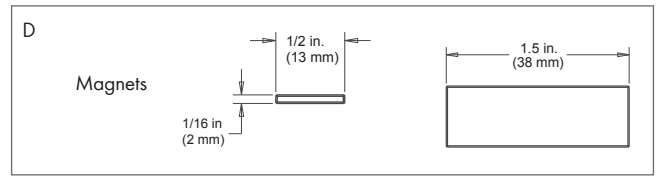

Back-to-Back Connectors

- Used with Square & Curved Channels Only
- 10 Per Pack

Item #	Quick Code	Description
RVEXTBTB10	T545	Back-to-Back Connectors (10 Per Pack)

TRESCO® FLEXTAPE 1.5W



Sold by roll

Specifications:

- Lumens: 150 per ft. (492 per m)
- Lamp Life: 50,000 Hours
- Mounting: Surface
- Warranty: 5 years
- Beam Angle: 115°
- Maximum continuous run in 20'
- Maximum per power supply is 40'
- Cuttable every 2"
- To be used on clean, smooth surfaces



Front
3/8"
(10 mm)

Back



Required Items		
Item #	Quick Code	Description
RVLEDFLXTPE-WROLL	T151	1.5W Per Foot, 20' FlexTape Roll, 2700K
RVLEDFLXTPE-NROLL	T445	1.5W Per Foot, 20' FlexTape Roll, 3500K
RVLEDFLXTPE-CROLL	T150	1.5W Per Foot, 20' FlexTape Roll, 4800K
RVLEDFLXTPE-DROLL	T823	1.5W Per Foot, 20' FlexTape Roll, 6500K

FlexTape 1.5W works with all TreSCO 12VDC power supplies.

Required Items		
Item #	Quick Code	Description
RVTPEPKT-2IN1	T824	2" 12VDC FlexTape Straight Starter Lead
RVLED-TPEPKT-2M	T147	79" (2 m) 12VDC FlexTape Straight Starter Lead
RVLED-TPEPKT-2MTEE	T180	79" (2 m) 12VDC FlexTape Tee Starter Lead

Optional Items		
Item #	Quick Code	Description
RVTPELNK-BTB	T479	Back-to-Back Connector
RVLED-TPELNK-TEE	T146	Tee Link Connector
RVLEDTPELNK-CON90	T152	90° Link Connector

Cuttable every 2" (50 mm)

Item #	Quick Code	Description
RVLED-TPELNK-5	T144	2" (5 cm) 12VDC FlexTape Link Cord
RVLED-TPELNK-15	T141	6" (15 cm) 12VDC FlexTape Link Cord
RVLED-TPELNK-25	T143	10" (25 cm) 12VDC FlexTape Link Cord
RVLED-TPELNK-60	T145	24" (60 cm) 12VDC FlexTape Link Cord
RVLED-TPELNK-120	T140	48" (120 cm) 12VDC FlexTape Link Cord
RVLED-TPELNK-180	T142	72" (180 cm) 12VDC FlexTape Link Cord

NOTE: Power Supplies on pages J-47 to J-51 and accessories on pages J-52 to J-64

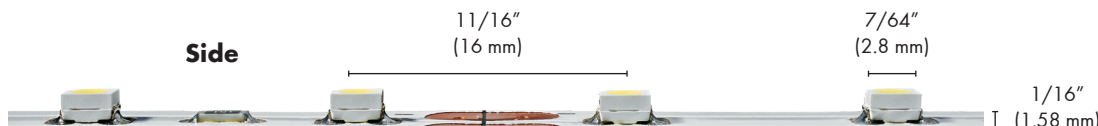

A
B
C
D
E
F
G
H
I
J
K
L
M
N
O
P
Q
R
S
T
U
V
W
X
Y

A TRESCO® FLEXTAPE 3W



Sold by roll

Specifications:

- Lumens: 365 per ft. (1197 per m)
- Lamp Life: 50,000 Hours
- Mounting: Surface
- Warranty: 5 years
- Beam Angle: 120°
- Maximum continuous run in 20'
- Maximum per power supply is 40'
- Cuttable every 2"
- To be used on clean, smooth surfaces



Front

3/8"
(10 mm)

Back



Cuttable every
2" (49 mm)

Required Items		
Item #	Quick Code	Description
RVLED-FLXTPE-WRHO	T318	3W Per Foot, 16.4' FlexTape Roll, 2700K
RVLED-FLXTPE-NRHO	T444	3W Per Foot, 16.4' FlexTape Roll, 3500K
RVLED-FLXTPE-CRHO	T319	3W Per Foot, 16.4' FlexTape Roll, 4800K
RVLED-FLXTPE-DRHO	T825	3W Per Foot, 16.4' FlexTape Roll, 6500K

FlexTape 3W works with all TreSCO 12VDC power supplies.

Required Items		
Item #	Quick Code	Description
RVTPEPKT-2IN1	T824	2" 12VDC FlexTape Straight Starter Lead
RVLED-TPEPKT-2M	T147	79" (2 m) 12VDC FlexTape Straight Starter Lead
RVLED-TPEPKT-2MTEE	T180	79" (2 m) 12VDC FlexTape Tee Starter Lead

Optional Items		
Item #	Quick Code	Description
RVTPELNK-BTB	T479	Back-to-Back Connector
RVLED-TPELNK-TEE	T146	Tee Link Connector
RVLED-TPELNK-CON90	T152	90° Link Connector

Item #	Quick Code	Description
RVLED-TPELNK-5	T144	2" (5 cm) 12VDC FlexTape Link Cord
RVLED-TPELNK-15	T141	6" (15 cm) 12VDC FlexTape Link Cord
RVLED-TPELNK-25	T143	10" (25 cm) 12VDC FlexTape Link Cord
RVLED-TPELNK-60	T145	24" (60 cm) 12VDC FlexTape Link Cord
RVLED-TPELNK-120	T140	48" (120 cm) 12VDC FlexTape Link Cord
RVLED-TPELNK-180	T142	72" (180 cm) 12VDC FlexTape Link Cord

NOTE: Power Supplies on pages J-47 to J-51 and accessories on pages J-52 to J-64

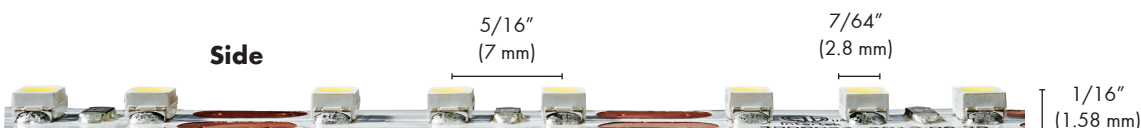

TRESCO® FLEXTAPE 4.4W



Sold by roll

Specifications:

- Lumens: 420 per ft. (2017 per m)
- Lamp Life: 50,000 Hours
- Mounting: Surface
- Warranty: 5 years
- Beam Angle: 115°
- Maximum continuous run in 13'
- Maximum per power supply is 13'
- Cuttable every 2"
- To be used on clean, smooth surfaces



Front
3/8"
(10 mm)

Back



Cuttable every 2" (50 mm)

Required Items		
Item #	Quick Code	Description
RVFLXTPE-WRV	T411	4.4W Per Foot, 13' FlexTape Roll, 2700K
RVFLXTPE-NRV	T438	4.4W Per Foot, 13' FlexTape Roll, 3500K
RVFLXTPE-CRV	T846	4.4W Per Foot, 13' FlexTape Roll, 4800K
RVFLXTPE-DRV	T826	4.4W Per Foot, 13' FlexTape Roll, 6500K

FlexTape 4.4W works with all TreSCO 12VDC power supplies.

Required Items		
Item #	Quick Code	Description
RVTPEPKT-2IN1	T824	2" 12VDC FlexTape Straight Starter Lead
RVLED-TPEPKT-2M	T147	79" (2 m) 12VDC FlexTape Straight Starter Lead
RVLED-TPEPKT-2MTEE	T180	79" (2 m) 12VDC FlexTape Tee Starter Lead

Optional Items		
Item #	Quick Code	Description
RVTPELNK-BTB	T479	Back-to-Back Connector
RVLED-TPELNK-TEE	T146	Tee Link Connector
RVLED-TPELNK-CON90	T152	90° Link Connector

Item #	Quick Code	Description
RVLED-TPELNK-5	T144	2" (5 cm) 12VDC FlexTape Link Cord
RVLED-TPELNK-15	T141	6" (15 cm) 12VDC FlexTape Link Cord
RVLED-TPELNK-25	T143	10" (25 cm) 12VDC FlexTape Link Cord
RVLED-TPELNK-60	T145	24" (60 cm) 12VDC FlexTape Link Cord
RVLED-TPELNK-120	T140	48" (120 cm) 12VDC FlexTape Link Cord
RVLED-TPELNK-180	T142	72" (180 cm) 12VDC FlexTape Link Cord

NOTE: Power Supplies on pages J-47 to J-51 and accessories on pages J-52 to J-64

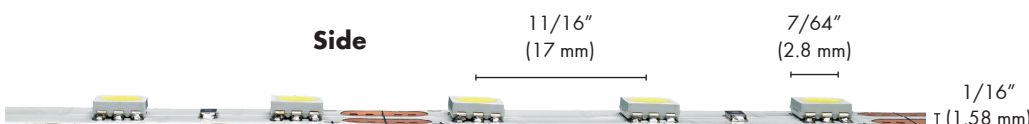

A
B
C
D
E
F
G
H
I
J
K
L
M
N
O
P
Q
R
S
T
U
V
W
X
Y

A TRESCO® EQUILINE TAPE LED 1.5W



Sold by roll

Specifications:

- Input Voltage: 12VDC
- Lamp Life: 25,000 Hours
- Mounting: Surface
- Warranty: 2 years
- Maximum continuous run in 20'
- Maximum per power supply is 40'
- Cutable every 2"
- To be used on clean, smooth surfaces



Required Items		
Item #	Quick Code	Description
RV-TPELED-27SER	T415	1.5W Per Foot, 20' Equiline FlexTape Roll, 2700K
RV-TPELED-35SER	T474	1.5W Per Foot, 20' Equiline FlexTape Roll, 3500K
RV-TPELED-48SER	T413	1.5W Per Foot, 20' Equiline FlexTape Roll, 4800K
RV-TPELED-65SER	T843	1.5W Per Foot, 20' Equiline FlexTape Roll, 6500K

EquiLine Tape 1.5W works with all TreSCO 12VDC power supplies.

Required Items		
Item #	Quick Code	Description
RVTPEPKT-2IN1	T824	2" 12VDC Straight Starter Lead
RVLED-TPEPKT-2M	T147	79" (2 m) 12VDC Straight Starter Lead
RVLED-TPEPKT-2MTEE	T180	79" (2 m) 12VDC Tee Starter Lead

Optional Items		
Item #	Quick Code	Description
RVTPELNK-BTB	T479	Back-to-Back Connector
RVLED-TPELNK-TEE	T146	Tee Link Connector
RVLED-TPELNK-CON90	T152	90° Link Connector

Item #	Quick Code	Description
RVLED-TPELNK-5	T144	2" (5 cm) 12VDC FlexTape Link Cord
RVLED-TPELNK-15	T141	6" (15 cm) 12VDC FlexTape Link Cord
RVLED-TPELNK-25	T143	10" (25 cm) 12VDC FlexTape Link Cord
RVLED-TPELNK-60	T145	24" (60 cm) 12VDC FlexTape Link Cord
RVLED-TPELNK-120	T140	48" (120 cm) 12VDC FlexTape Link Cord
RVLED-TPELNK-180	T142	72" (180 cm) 12VDC FlexTape Link Cord

NOTE: Power Supplies on pages J-47 to J-51 and accessories on pages J-52 to J-64

Front
3/8"
(10 mm)

Back



Cutable every 2" (50 mm)

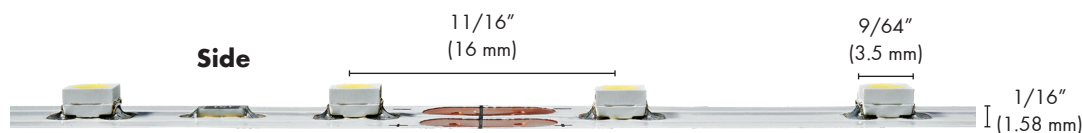

TRESCO® EQUILINE TAPE LED 3W

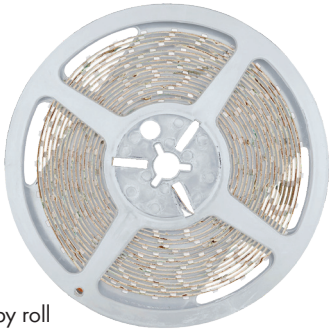

Sold by roll

Specifications:

- Input Voltage: 12VDC
- Lamp Life: 25,000 Hours
- Mounting: Surface
- Warranty: 2 years
- Maximum continuous run in 16.4'
- Maximum per power supply is 20'
- Cuttable every 1"
- To be used on clean, smooth surfaces



Front

3/8"
(10 mm)

Back



Cuttable every
1" (25 mm)

Required Items		
Item #	Quick Code	Description
RVTPELED-27HER	T416	3W Per Foot, 16.4' EquiLine FlexTape Roll, 2700K
RVTPELED-35HER	T473	3W Per Foot, 16.4' EquiLine FlexTape Roll, 3500K
RVTPELED-48HER	T414	3W Per Foot, 16.4'T EquiLine FlexTape Roll, 4800K
RVTPELED-65HER	T420	3W Per Foot, 16.4'T EquiLine FlexTape Roll, 6500K

EquiLine Tape 3W works with all TreSCO 12VDC power supplies.

Required Items		
Item #	Quick Code	Description
RVTPEPKT-2IN1	T824	2" 12VDC Straight Starter Lead
RVLED-TPEPKT-2M	T147	79" (2 m) 12VDC Straight Starter Lead
RVLED-TPEPKT-2MTEE	T180	79" (2 m) 12VDC Tee Starter Lead

Optional Items		
Item #	Quick Code	Description
RVTPELNK-BTB	T479	Back-to-Back Connector
RVLED-TPELNK-TEE	T146	Tee Link Connector
RVLEDTPELNK-CON90	T152	90° Link Connector

Item #	Quick Code	Description
RVLED-TPELNK-5	T144	2" (5 cm) 12VDC FlexTape Link Cord
RVLED-TPELNK-15	T141	6" (15 cm) 12VDC FlexTape Link Cord
RVLED-TPELNK-25	T143	10" (25 cm) 12VDC FlexTape Link Cord
RVLED-TPELNK-60	T145	24" (60 cm) 12VDC FlexTape Link Cord
RVLED-TPELNK-120	T140	48" (120 cm) 12VDC FlexTape Link Cord
RVLED-TPELNK-180	T142	72" (180 cm) 12VDC FlexTape Link Cord

NOTE: Power Supplies on pages J-47 to J-51 and accessories on pages J-52 to J-64

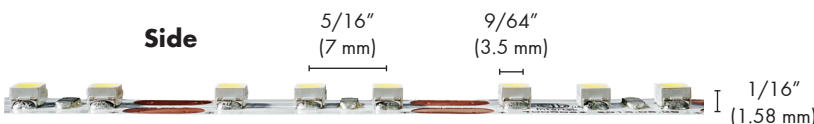

A
B
C
D
E
F
G
H
I
J
K
L
M
N
O
P
Q
R
S
T
U
V
W
X
Y

A TRESKO® EUROLINX

B Specifications:

Lumens: 216 per ft. (708 per m)

Warranty: 5 years

Each light includes: 79" Starter Cord

Lamp Life: 50,000 Hours

Beam Angle: 120°

with AMP Connector and U-Clips for

Mounting: Surface

Linkable up to 10'

mounting.

U-Clip mounted



Front

1-3/16"
(30 mm)

Side

5/16"
(8 mm)

Required Items		
Item #	Quick Code	Description
RVEUL3W-197CAL	T428	7.75" L, 3 Watts, 5000K
RVEUL3W-197WAL	T429	7.75" L, 3 Watts, 3000K
RVEUL4W-273CAL	T613	10.75" L, 4 Watts, 5000K
RVEUL4W-273WAL	T548	10.75" L, 4 Watts, 3000K
RVEUL7W-502CAL	T430	19.75" L, 7 Watts, 5000K
RVEUL7W-502WAL	T431	19.75" L, 7 Watts, 3000K
RVEUL11W-06CAL	T424	31.75" L, 11 Watts, 5000K
RVEUL11W-06WAL	T425	31.75" L, 11 Watts, 3000K
RVEUL15W1111CAL	T426	43.75" L, 15 Watts, 5000K
RVEUL15W1111WAL	T427	43.75" L, 15 Watts, 3000K

7-3/4"
(197 mm)

10-3/4"
(273 mm)

19-3/4"
(502 mm)

31-3/4"
(806 mm)

43-3/4"
(1111 mm)

Power Supplies		
Item #	Quick Code	Description
RVDC-ELT6WP-CON	T543	6W Wall Mount with 3 AMP Ports Mounting Block
RVDC-ELT15WP-CON	T362	15W Wall Mount with 6 AMP Ports Mounting Block
RVDC-ELT18-CON	T100	18W with 6 AMP Ports Mounting Block
RVDC-EQ30	T605	30W Power Supply with 6 AMP Ports Mounting Block
RVDC-EQ60	T606	60W with 6 AMP Ports Mounting Block
RVDCE30D-CON	T611	30W Wall Dimmable Hardwire Power Supply with 6 AMP Ports
RVDCE60D-CON	T537	60W Wall Dimmable Hardwire with 6 AMP Ports

Optional Items - Link Cord, Links Two Eurolinx Together					
Item #	Quick Code	Size	Item #	Quick Code	Size
RVEULNK-WH	T433	6"	RVEULNK-120-WH	T432	48"
RVEULNK-25-WH	T435	10"	RVEULNK-180-WH	T434	72"
RVEULNK-60-WH	T436	24"			

Item #	Quick Code	Description
RVEUL-GTD	T423	27 Watts Inline Gradual Touch Dimmer, Controls up to 6.75' of Eurolinx lights (maximum 27 watts)
RVEUL-UCLP1	T821	Extra U-Clips (2 Pack)
RVEULNK-BTBGY1	T822	Extra Back-to-Back Link

NOTE: Power Supplies on pages J-47 to J-51 and accessories on pages J-52 to J-64

TRESCO® SIMPLED 2.0

Specifications:

Lumens: 470 per ft. (1,541 per m) Warranty: 3 years
 Lamp Life: 50,000 Hours Beam Angle: 110°
 Mounting: Surface Linkable up to 10'

Each light includes: 3 different diffusers (Clear, Frosted and Milk) and 79" Starter Cord with AMP Connector and U-Clips for mounting.



Required Items		
Item #	Quick Code	Description
RVSMPHO8-CNI	T469	SimpLED 2.0, 8" Length, 3.35 Watts, 5000K
RVSMPHO8-WNI	T470	SimpLED 2.0, 8" Length, 3.35 Watts, 3000K
RVSMPHO12-CNI	T465	SimpLED 2.0, 12" Length, 5 Watts, 5000K
RVSMPHO12-WNI	T466	SimpLED 2.0, 12" Length, 5 Watts, 3000K
RVSMPHO22-CNI	T467	SimpLED 2.0, 22" Length, 9.2 Watts, 5000K
RVSMPHO22-WNI	T468	SimpLED 2.0, 22" Length, 9.2 Watts, 3000K

Power Supplies		
Item #	Quick Code	Description
RVDC-ELT6WP-CON	T543	6W Wall Mount Power w/3 AMP Ports Mount Block
RVDC-ELT15WP-CON	T362	15W Wall Mount Supply w/6 AMP Ports Mount Block
RVDC-ELT18-CON	T100	18W Power Supply with 6 AMP Ports Mounting Block
RVDC-EQ30	T605	30W Power Supply with 6 AMP Ports Mounting Block
RVDC-EQ60	T606	60W Power Supply with 6 AMP Ports Mounting Block
RVDCE30D-CON	T611	30W Wall Dimmable Hardwire Power Supply with 6 AMP Ports
RVDCE60D-CON	T537	60W Wall Dimmable Hardwire Power Supply w/6 AMP Ports

Optional Items		
Item #	Quick Code	Description
RVLED-SMPLNK-5	T123	2" Link Cord, Links Two SimplEDs Together
RVLED-SMPLNK-15	T529	6" Link Cord, Links Two SimplEDs Together
RVLED-SMPLNK-25	T122	10" Link Cord, Links Two SimplEDs Together
RVLED-SMPLNK-60	T124	24" Link Cord, Links Two SimplEDs Together
RVLED-SMPLNK-120	T119	48" Link Cord, Links Two SimplEDs Together
RVLED-SMPLNK-180	T121	72" Link Cord, Links Two SimplEDs Together

Item #	Quick Code	Description
RVLED-SMPMOT	T125	27 W, Inline Motion Sensor, 4-1/8"L x 3/4"W x 3/8"H, Max of 5.5' of SimplED 2.0 lights
RVLED-SMPHOTO	T245	27 W, Inline Photo Sensor, 2-3/4"L x 3/4"W x 3/8"H, Max of 5.5' of SimplED 2.0 lights
RVLED-SMPTD4	T126	27 W, Inline Touch Dimmer, 2-3/4"L x 3/4"W x 3/8"H, Max of 5.5' of SimplED 2.0 lights

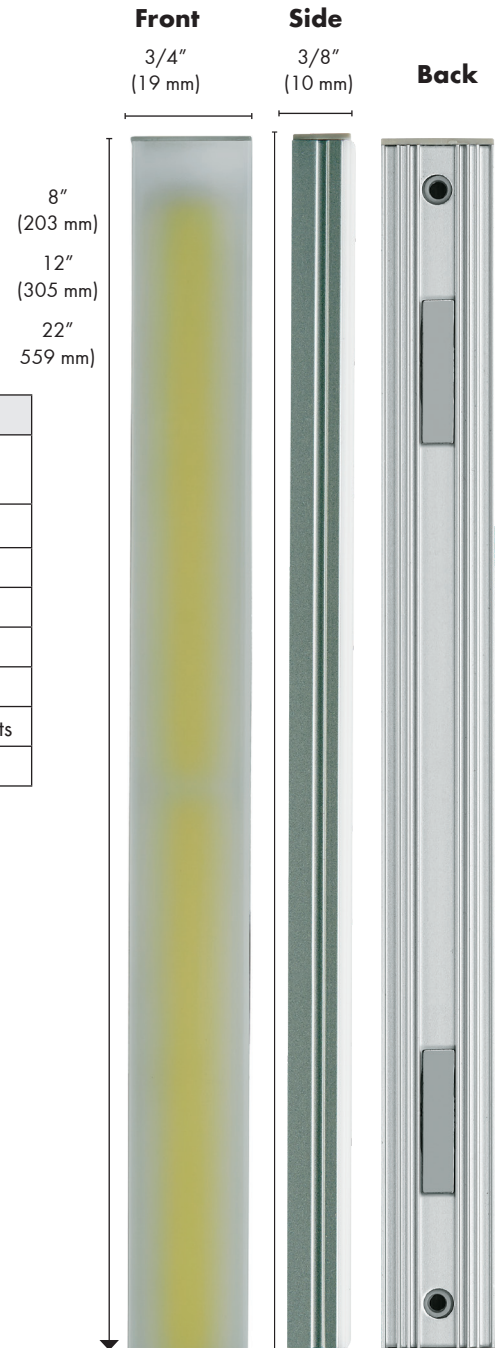

NOTE: Power Supplies on pages J-47 to J-51 and accessories on pages J-52 to J-64

A TRESKO® FINELINE 2.0

Specifications:

Lumens: 330 per ft. (1082 per m)
 Lamp Life: 50,000 Hours
 Mounting: Surface
 U-Clip mounted
 4.4W per ft.

Warranty: 5 years
 Beam Angle: 120°
 Linkable up to 12'

Each light includes: 79" Starter Cord with AMP Connector and U-Clips for mounting.

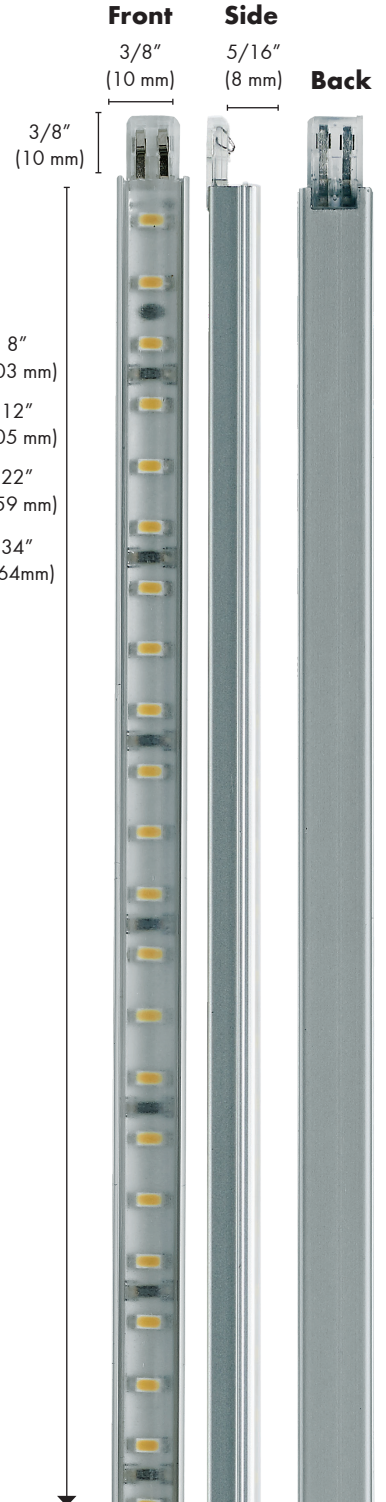

Required Items - Fineline Stick LED Light		
Item #	Quick Code	Description
RVSTKHO8-CNI	T637	8"L, 2.93W, 5000K, Nickel Finish
RVSTKHO8-WNI	T638	8"L, 2.93W, 3000K, Nickel Finish
RVSTKHO12-CNI	T631	12"L, 4.4W, 5000K, Nickel Finish
RVSTKHO12-WNI	T632	12"L, 4.4W, 3000K, Nickel Finish
RVSTKHO22-CNI	T633	22"L, 8.07W, 5000K, Nickel Finish
RVSTKHO22-WNI	T634	22"L, 8.07W, 3000K, Nickel Finish
RVSTKHO34-CNI	T635	34"L, 12.47W, 5000K, Nickel Finish
RVSTKHO34-WNI	T636	34"L, 12.47W, 3000K, Nickel Finish

Power Supplies		
Item #	Quick Code	Description
RVDC-ELT6WP-CON	T543	6W Wall Mount with 3 AMP Ports Mounting Block
RVDC-ELT15WP-CON	T362	15W Wall Mount with 6 AMP Ports Mounting Block
RVDC-ELT18-CON	T100	18W with 6 AMP Ports Mounting Block
RVDC-EQ30	T605	30W Power Supply with 6 AMP Ports Mounting Block
RVDC-EQ60	T606	60W with 6 AMP Ports Mounting Block
RVDCE30D-CON	T611	30W Wall Dimmable Hardwire Power Supply with 6 AMP Ports
RVDCE60D-CON	T537	60W Wall Dimmable Hardwire with 6 AMP Ports

Optional Items		
Item #	Quick Code	Description
RVLED-STKDIM-TD4	T133	Inline Touch Dimmer, 4 Step (low, medium, high, off)

Item #	Quick Code	Description
RVLED-STKLNK-5	T138	2" Fineline Stick Linking Cord
RVLED-STKLNK-15	T135	6" Fineline Stick Linking Cord
RVLED-STKLNK-25	T137	10" Fineline Stick Linking Cord
RVLED-STKLNK-60	T139	24" Fineline Stick Linking Cord
RVLED-STKLNK-120	T134	48" Fineline Stick Linking Cord
RVLED-STKLNK-180	T136	72" Fineline Stick Linking Cord

NOTE: Power Supplies on pages J-47 to J-51 and accessories on pages J-52 to J-64

TRESCO® POWER POCKET® 3W

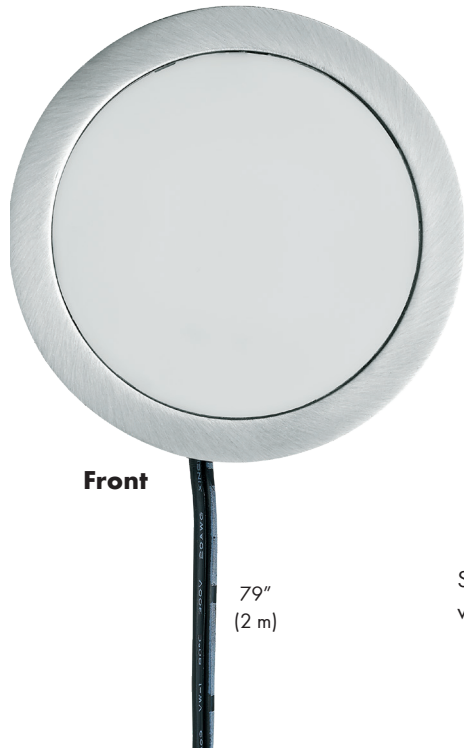

2-1/2"
(63 mm)

Specifications:

Lumens: 234

Lamp Life: 50,000 Hours

Mounting: Recess/Surface

Warranty: 5 years

Beam Angle: 120°

* Dimmable on trailing edge (12V side). Mounting block and power cord included.

† No minimum load when controlled by dimmer, mounting block sold separately.

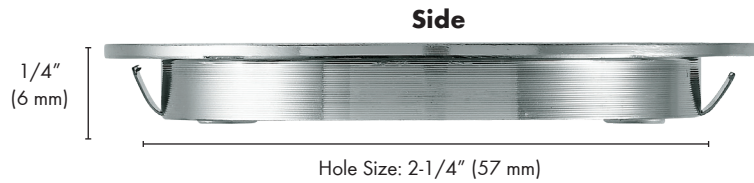

1/4"
(6 mm)

Hole Size: 2-1/4" (57 mm)

Surface Mount Ring is included with each light.



Item #	Quick Code	Description
3W LED Power Pocket, 5000K		
RVPOC-3LEDSFR-CBL	T191	Black Finish
RVPOC-3LEDSFR-CNI	T232	Nickel Finish
RVPOC-3LEDSFR-CWH	T294	White Finish
3W LED Power Pocket, 3000K		
RVPOC-3LEDSFR-WBL	T162	Black Finish
RVPOC-3LEDSFR-WCH	T293	Chrome
RVPOC-3LEDSFR-WNI	T163	Nickel Finish
RVPOC3LEDSFR-WORB	T166	Oil Rubbed Bronze Finish
RVPOC-3LEDSFR-WWH	T164	White Finish

Power Supplies		
Item #	Quick Code	Description
RVDC-ELT6WP-CON	T543	6W Wall Mount Power Supply with 3 AMP Ports Mounting Block
RVDC-ELT15WP-CON	T362	15W Wall Mount Power Supply with 6 AMP Ports Mounting Block
RVDC-ELT18-CON	T100	18W Power Supply with 6 AMP Ports Mounting Block
RVDC-EQ30	T605	30W Power Supply with 6 AMP Ports Mounting Block
RVDC-EQ60	T606	60W Power Supply with 6 AMP Ports Mounting Block
RVDC-30D-CON	T611	30W Wall Dimmable Hardwire Power Supply with 6 AMP Ports
RVDC-60D-CON	T537	60W Wall Dimmable Hardwire Power Supply with 6 AMP Ports

NOTE: Power Supplies on pages J-47 to J-51 and accessories on pages J-52 to J-64

A
B
C
D
E
F
G
H
I
J
K
L
M
N
O
P
Q
R
S
T
U
V
W
X
Y

A TRESKO® POWER POCKIT® 5W

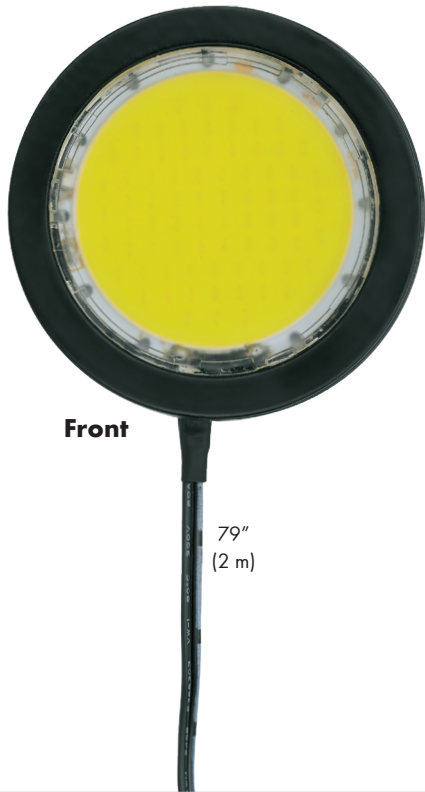

Front

79"
(2 m)

2-1/2"
(63 mm)

Specifications:

- Lumens: 290
- Lamp Life: 50,000 Hours
- Mounting: Recess/Surface
- Warranty: 5 years
- Beam Angle: 100°



* Dimmable on trailing edge (12V side). Mounting block and power cord included.
 † No minimum load when controlled by dimmer, mounting block sold separately.

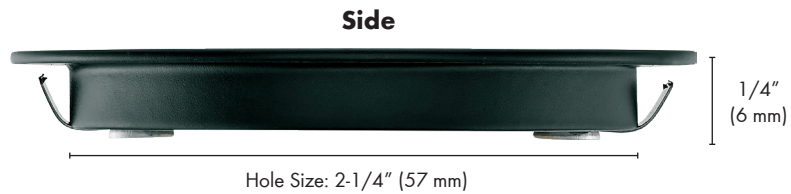

Side

1/4"
(6 mm)

Hole Size: 2-1/4" (57 mm)



Item #	Quick Code	Description
RVPOC-5LEDSCL-CBL	T458	5W LED Power Pockit with Luniform Technology, 5000K, Black Finish
RVPOC-5LEDSCL-CNI	T459	5W LED Power Pockit with Luniform Technology, 5000K, Nickel Finish
RVPOC-5LEDSCL-CWH	T460	5W LED Power Pockit with Luniform Technology, 5000K, White Finish
RVPOC-5LEDSCL-WBL	T461	5W LED Power Pockit with Luniform Technology, 3000K, Black Finish
RVPOC-5LEDSCL-WNI	T462	5W LED Power Pockit with Luniform Technology, 3000K, Nickel Finish
RVPOC-5LEDSCL-WORB	T463	5W LED Power Pockit with Luniform Technology, 3000K, Oil Rubbed Bronze Finish
RVPOC-5LEDSCL-WWH	T464	5W LED Power Pockit with Luniform Technology, 3000K, White Finish

Power Supplies		
Item #	Quick Code	Description
RVDC-ELT6WP-CON	T543	6W Wall Mount Power Supply with 3 AMP Ports Mounting Block
RVDC-ELT15WP-CON	T362	15W Wall Mount Power Supply with 6 AMP Ports Mounting Block
RVDC-ELT18-CON	T100	18W Power Supply with 6 AMP Ports Mounting Block
RVDC-EQ30	T605	30W Power Supply with 6 AMP Ports Mounting Block
RVDC-EQ60	T606	60W Power Supply with 6 AMP Ports Mounting Block
RVDCE30D-CON	T611	30W Wall Dimmable Hardwire Power Supply with 6 AMP Ports
RVDCE60D-CON	T537	60W Wall Dimmable Hardwire Power Supply with 6 AMP Ports

NOTE: Power Supplies on pages J-47 to J-51 and accessories on pages J-52 to J-64

TRESCO® EQUILINE PUCK

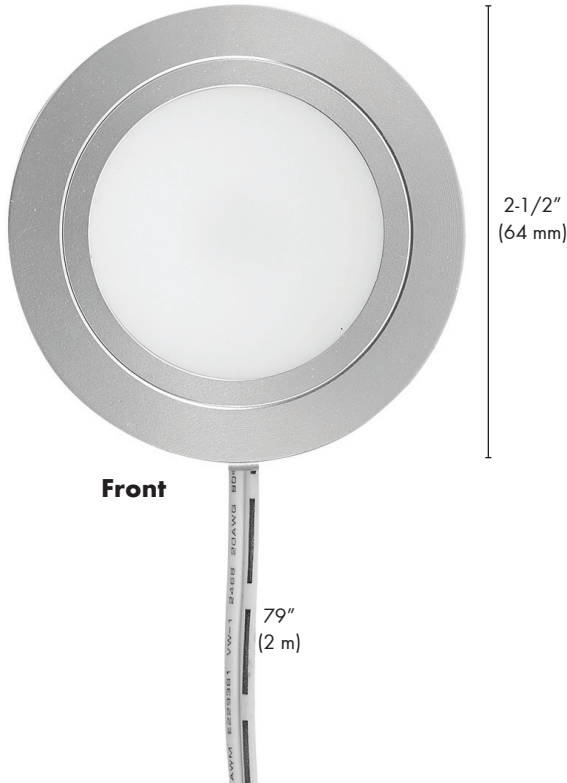

Specifications:

- Lumens: 218
- Lamp Life: 25,000 Hours
- Mounting: Recess/Surface
- Warranty: 2 years
- Beam Angle: 100°



* Dimmable on trailing edge (12V side). Mounting block and power cord included.
 † No minimum load when controlled by dimmer, mounting block sold separately.

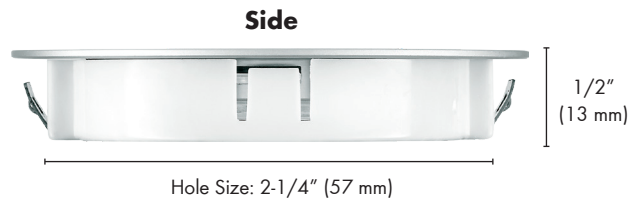

Item #	Quick Code	Description
RVPOC-3EQFR-WBL	T556	3W, 12V EquiLine Puck Light, 3000K, Black Finish
RVPOC-3EQFR-WNI	T539	3W, 12V EquiLine Puck Light, 3000K, Nickel Finish
RVPOC-3EQFR-CBL	T864	3W, 12V EquiLine Puck Light, 5000K, Black Finish
RVPOC-3EQFR-CNI	T538	3W, 12V EquiLine Puck Light, 5000K, Nickel Finish

Power Supplies		
Item #	Quick Code	Description
RVDC-ELT6WP-CON	T543	6W Wall Mount Power Supply with 3 AMP Ports Mounting Block
RVDC-ELT15WP-CON	T362	15W Wall Mount Power Supply with 6 AMP Ports Mounting Block
RVDC-ELT18-CON	T100	18W Power Supply with 6 AMP Ports Mounting Block
RVDC-EQ30	T605	30W Power Supply with 6 AMP Ports Mounting Block
RVDC-EQ60	T606	60W Power Supply with 6 AMP Ports Mounting Block
RVDCE30D-CON	T611	30W Wall Dimmable Hardwire Power Supply with 6 AMP Ports
RVDCE60D-CON	T537	60W Wall Dimmable Hardwire Power Supply with 6 AMP Ports

Optional Items		
Item #	Quick Code	Description
RVSMR-2LED-BLK	T645	EquiLine Puck Light Surface Mount Ring, Black Finish
RVSMR-2LED-NI	T360	EquiLine Puck Light Surface Mount Ring, Nickel Finish

NOTE: Power Supplies on pages J-47 to J-51 and accessories on pages J-52 to J-64

A
B
C
D
E
F
G
H
I
J
K
L
M
N
O
P
Q
R
S
T
U
V
W
X
Y

A TRESCO® POCKIT POINT & LAZY SUSAN LIGHT KIT

B
C
D
E
F
G
H
I
J
K
L
M
N
O
P
Q
R
S
T
U
V
W
X
Y



Tresco Pockit Point

Specifications:

Lumens: 69
 Beam Angle: 90°
 Lamp Life: 30,000 Hours
 Input Voltage: 12VDC
 Mounting: Recessed
 Bore Hole: 1" Dia.

Warranty: 1 Year
 Height: 1/2"
 Includes: 79" Cord
 Includes: Mini converter



Item #	Quick Code	Description
RVLED-1EB-CBL	T274	1W Pockit Point, 5000K, Black Finish
RVLED-1EB-CWH	T865	1W Pockit Point, 5000K, White Finish
RVLED-1EB-WBL	T111	1W Pockit Point, 3000K, Black Finish
RVLED-1EB-WNI	T112	1W Pockit Point, 3000K, Nickel Finish
RVLED-1EB-WWH	T113	1W Pockit Point, 3000K, White Finish

Power Supplies

Item #	Quick Code	Description
RVDC-ELT6WP-CON	T543	6W Wall Mount Power Supply with 3 AMP Ports Mounting Block
RVDC-ELT15WP-CON	T362	15W Wall Mount Power Supply with 6 AMP Ports Mounting Block
RVDC-ELT18-CON	T100	18W Power Supply with 6 AMP Ports Mounting Block
RVDC-EQ30	T605	30W Power Supply with 6 AMP Ports Mounting Block
RVDC-EQ60	T606	60W Power Supply with 6 AMP Ports Mounting Block
RVDCE30D-CON	T611	30W Wall Dimmable Hardwire Power Supply with 6 AMP Ports
RVDCE60D-CON	T537	60W Wall Dimmable Hardwire Power Supply with 6 AMP Ports

NOTE: Power Supplies on pages J-47 to J-51 and accessories on pages J-52 to J-64

Tresco Lazy Susan Light Kit

Kit Includes:
 23"L Angled Elli LED Linear Light
 Door Sensor
 6W Plug-In Power Supply w/Terminal Block
 Wire Management Clips

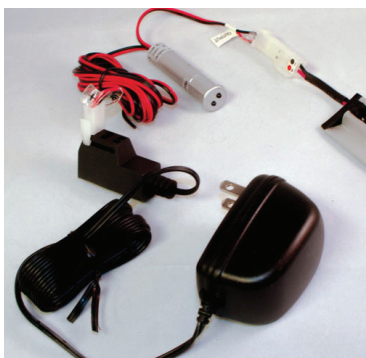

Item #	Quick Code	Description
RVLED-LSKA1	T383	6W, 23"L, Lazy Susan Light Kit



TRESCO POWER SUPPLIES

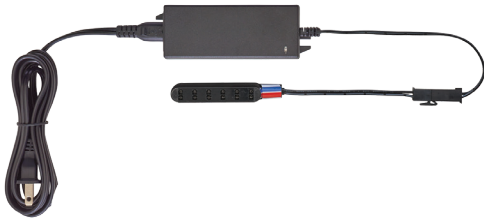

**12 Volt Commercial Plug-In Power Supply
18 Watts**



- 12VDC constant voltage output
- Short circuit protection*
- Overcurrent protection
- Overload protection*
- RFI protection
- Dimmable on trailing edge (12VDC side)
- **Includes: mounting block w/6 ports & 6' power cord**
- Compatible with all Tresco® low voltage dimmers
- **NOT compatible with hardwire wall dimmers**
- * Automatic reset (no fuses)



Item #	Quick Code	Description	Size
RVDC-ELT18-CON	T100	12VDC/18W Power Supply w/6 Snap Mounting Block	1-11/16"W x 1-1/4"H x 4-1/4"L



A

**12 Volt Commercial Plug-In Power Supplies
30 Watts & 60 Watts**



- Slim design, under 1" height
- 12VDC constant voltage output
- High power factor (PF > .95)
- Short circuit protection*
- Overcurrent protection
- Overload protection*
- RFI protection
- Dimmable on trailing edge (12VDC side)
- Class 2
- **Includes: mounting block w/6 ports & 8' power cord**
- Compatible with all Tresco® low voltage dimmers
- **NOT compatible with hardwire wall dimmers**
- * Automatic reset (no fuses)



B



Item #	Quick Code	Description	Size	
A	RVDC-SLELT30	T625	12VDC/30W Power Supply w/Mounting Block	2-1/8"W x 13/16"H x 6-1/8"L
B	RVDC-SLELT60	T626	12VDC/60W Power Supply w/Mounting Block	2-3/8"W x 15/16"H x 7"L

A TRESCO POWER SUPPLIES



10' Cord from Plug to Barrel Connector



24 Volt Commercial Plug-In Power Supply 15 Watts



- 24VDC constant voltage output
- Fully enclosed wall mount plastic case
- Single barrel connector output
- Short circuit protection*
- Overcurrent protection
- Overload protection*
- RFI protection
- Dimmable on trailing edge (24VDC side)
- Class 2, 2-Year warranty
- Compatible with all Tresco low voltage dimmers
- **NOT compatible with hardwire wall dimmers**
- *Automatic Reset (no fuses)

Item #	Quick Code	Description	Size
RV24DCELT15WP	T841	24VDC/15W Wall Mnt Power Supply w/Barrel Connector	1-5/8"W x 1-1/4"H x 3"L

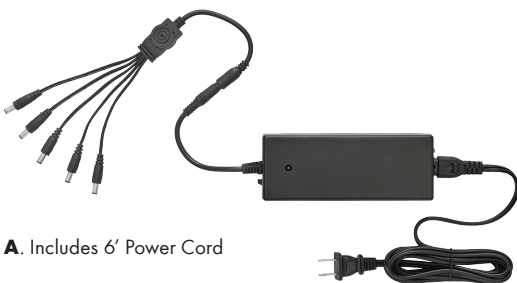

A. Includes 6' Power Cord

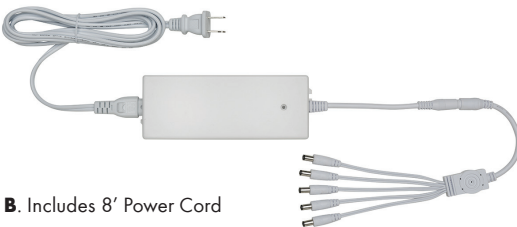

B. Includes 8' Power Cord



24 Volt Commercial Plug-In Power Supplies 48 Watts & 96 Watts



- Slim design, under 1.6" height
- 24VDC constant voltage output
- High power factor (Pf > .95) 96W only
- Short circuit protection*
- Overcurrent protection
- Overload protection*
- RFI protection
- Dimmable on trailing edge (24VDC side)
- Class 2
- **Includes: 5 barrel wires**
- Compatible with all Tresco® low voltage dimmers
- **NOT compatible with hardwire wall dimmers**
- * Automatic reset (no fuses)

	Item #	Quick Code	Description	Size
A	RV24DCELT48-BL	T653	24VDC/48W Power Supply w/5 Barrel Wires - Black	2-3/8"W x 1-1/2"H x 6"L
B	RV24DCELT96	T577	24VDC/96W Power Supply w/5 Barrel Wires - White	2-5/16"W x 1-5/16"H x 7-1/16"L

TRESCO POWER SUPPLIES



**12 Volt EquiLine
Plug-In Power Supplies
6 Watts / 15 Watts / 30 Watts / 60 Watts**



A. 10' Cord from Plug to Mounting Block

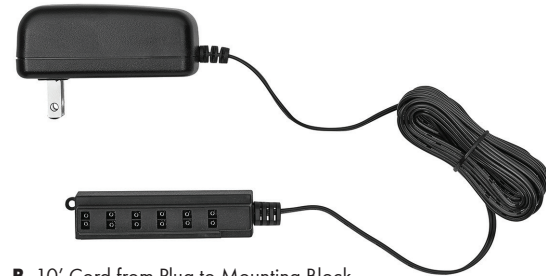

B. 10' Cord from Plug to Mounting Block

- 12VDC constant voltage output
- Short circuit protection*
- Overcurrent protection
- Overload protection*
- RFI protection
- Dimmable on trailing edge (12VDC side)
- Class 2
- 2-Year warranty
- **Includes: mounting block**
- Compatible with all Tresco® low voltage dimmers
- **NOT compatible with hardwire wall dimmers**
- * Automatic reset (no fuses)



C. Includes 8' Power Cord



D. Includes 8' Power Cord

Item #	Quick Code	Description	Size
A	T543	12VDC/6W Power Supply & Mnting Block w/3 Ports	1-1/2"W x 1-1/2"H x 2-3/4"L
B	T362	12VDC/15W Power Supply & Mnting Block w/6 Ports	1-5/8"W x 1-1/4"H x 3"L
C	T605	12VDC/30W Power Supply & Mnting Block w/6 Ports	2-1/8"W x 13/16"H x 6-1/8"L
D	T606	12VDC/60W Power Supply & Mnting Block w/6 Ports	2-3/8"W x 15/16"H x 7"L

A TRESCO POWER SUPPLIES

A
B
C
D
E
F
G
H
I
J
K
L
M
N
O
P
Q
R
S
T
U
V
W
X
Y



A



B

**12 Volt Commercial Wall Dimmable Hardwire Power Supplies
30 Watts & 60 Watts**



- Under 1" height
- 12VDC constant voltage output
- High power factor (Pf > .95)
- Dimmable by standard LED wall dimmers
- Continuous smooth dimming
- Wire directly into unit
- Quiet operation
- Electronic units are lower profile and generate less heat than magnetic transformers
- Includes: mounting block w/6 ports
- Dimmable by LED line voltage (120V) wall dimmers
- RFI Protection
- Class 2 with short circuit and automatic reset



	Item #	Quick Code	Description	Size
A	RVDCE30D-CON	T611	12VDC/30W Wall Dimmable Hardwire Power Supply	2-1/8"W x 13/16"H x 6-1/8"L
B	RVDCE60D-CON	T537	12VDC/60W Wall Dimmable Hardwire Power Supply	2-3/8"W x 15/16"H x 7"L



A



B

**12 Volt Industrial Wall Dimmable Hardwire Power Supplies
60 Watts & 180 Watts**



- Slim design, under 2" height
- 12VDC constant voltage output
- High power factor (Pf > .95)
- Built-in hardwire compartment
- All metal construction
- Short circuit protection*
- Overcurrent protection
- Overload protection*
- RFI protection
- Dimmable by standard LED wall dimmers
- Class 2
- Compatible with all Tresco® low voltage dimmers
- Compatible with hardwired LED wall dimmers
- Does not include mounting block
- Requires electrician to install
- * Automatic reset (no fuses)



	Item #	Quick Code	Description	Size
A	RV12DCH60X1	T621	12VDC/60W Industrial Wall Dimmable Hardwire Power Supply	3-5/8"W x 1-11/16"H x 7-3/8"L
B	RV12DCH60X3	T622	12VDC/180W Industrial Wall Dimmable Hardwire Power Supply	4-1/4"W x 1-3/4"H x 10-15/16"L

TRESCO POWER SUPPLIES & TERMINAL BLOCKS



A



B

24 Volt Industrial Wall Dimmable Hardwire Power Supplies 96 Watts & 288 Watts



- Slim design, under 2" height
- 24VDC constant voltage output
- High power factor (PF>.95)
- Built-in hardwire compartment
- All metal construction
- Short circuit protection*
- Overcurrent protection
- Overload protection*
- RFI protection
- Dimmable by standard LED wall dimmers
- Class 2
- Compatible with all Tresco® low voltage dimmers
- Compatible with hardwired LED wall dimmers
- Does not include 5 Output Barrel
- Mounting block not included
- Requires electrician to install
- Dimmable by LED line voltage (120V) wall dimmers
- * Automatic reset (no fuses)



Item #	Quick Code	Description	Size
A	RV24DCH96X1	T623 24VDC/96W Hardwire Wall Dimmable Power Supply	3-11/16"W x 1-11/16"H x 8-11/16"L
B	RV24DCH96X3	T624 24VDC/288W Hardwire Wall Dimmable Power Supply	4-1/4"W x 1-3/4"H x 11-15/16"L

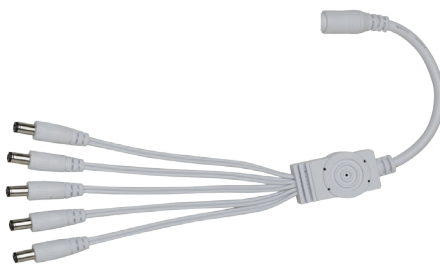

Extra 5 Output Barrel Splice



- Designed for Tresco's 24 Volt Power Supplies
- 5 Barrel Connector Wires

Item #	Quick Code	Description
RV1BRL5	T574	Extra 5 Output Barrel Splice



Terminal Block



- Compatible with all Tresco low voltage dimmers
- NOT compatible with hardwire wall dimmers

Item #	Quick Code	Description	Finish
RVTRANS-MNT-BL	T179	Additional Terminal Block with 6 AMP Ports, Cord is 6"L	Black

A TRESKO SWIDGET

Tresco has developed the Swidget line which consists of “smart” outlets and switches. The outlets and switches can be controlled remotely from your mobile phone via the Swidget App.



Swidget App



With knowledge and control at your fingertips, the Swidget App allows you to control your device while 12VDC constant voltage output monitoring power consumption accurately and in real-time.

- Power On/Of your outlet or switch
- Program schedules, create scenes and set automations
- Monitor your energy consumption and set automatic notifications including when power consumption is too high
- Connect inserts to trigger one another for a complete smart home system
- Voice control your Swidget Wi-Fi connected inserts by using Alexa, Google Assistant and IFTTT enabled devices

Swidget Set Up

Plug-In Power Supply

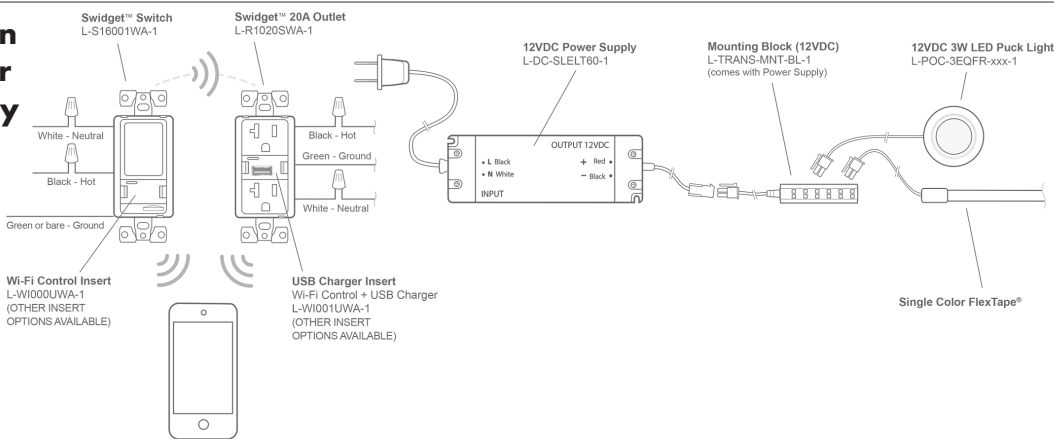

Hardwire Power Supply

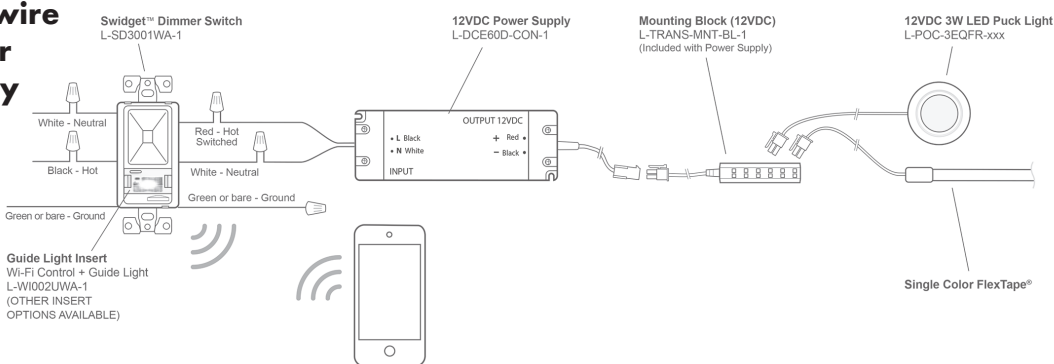

TRESCO SWIDGET

Swidget Devices with Wi-Fi Control Inserts



Swidget Outlet w/Wi-Fi Control Insert

- Independent power monitoring for each of the (2) receptacles with Wi-Fi enabled control insert with the Swidget App
- **Top receptacle** is always "on" and allows for wireless power monitoring
- **Bottom receptacle** allows for wireless "on/off" control and power monitoring
- Fits all electrical boxes 3" x 2" x 2.5" and larger
- Tamper resistant shutters for safe operation
- Wireless Band: 2.4GHz
- Device Compatibility: Amazon Alexa, Google Assistant, IFTTT
- Neutral wire required for installation
- Electrician required for install, works with all standard rocker switch plates (not included)



Item #	Quick Code	Description	Color
RVR1020WI000	T929	120VAC 20A Swidget Outlet, w/ Wi-Fi Control Insert	White

A
B
C
D
E
F
G
H
I
J
K
L
M
N
O
P
Q
R
S
T
U
V
W
X
Y



Swidget Standard Switch w/Wi-Fi Control Insert

- Single pole and 3-way wiring compatible for lighting and fan applications
- Capability for scene programming with Wi-Fi control insert
- 300W LED/CFL load rating
- Fits all electrical boxes 3" x 2" x 2.5" and larger
- Wireless Band: 2.4GHz
- Device Compatibility: Amazon Alexa, Google Assistant, IFTTT
- Neutral wire required for installation
- Electrician required for install, works with all standard rocker switch plates (not included)



Item #	Quick Code	Description	Color
RVS16001WI000	T927	120VAC 300W/600W Swidget On/Of Switch w/Wi-Fi Control	White



Swidget Dimmer Switch w/Wi-Fi Control Insert

- Unique on/of /dimmer control in a single pad with the capability for scene programming with a Wi-Fi control insert
- 150W LED/CFL load rating
- Compatible with all Tresco dimmable power supplies
- Fits all electrical boxes 3" x 2" x 2.5" and larger
- Wireless Band: 2.4GHz
- Device Compatibility: Amazon Alexa, Google Assistant, IFTTT
- Neutral wire required for installation
- Electrician required for install, works with all standard rocker switch plates (not included)



Item #	Quick Code	Description	Color
RVSD300WI000	T928	120VAC 150W/300W Swidget Dimmer Switch w/Wi-Fi Control	White

A TRESKO SWIDGET

If you are looking for more options than just standard Wi-Fi Control, then Swidget Devices without Inserts are the answer. They allow you to choose Wi-Fi Inserts that have options like a USB Charger, Night Light or Motion Sensor (see Inserts on next page).

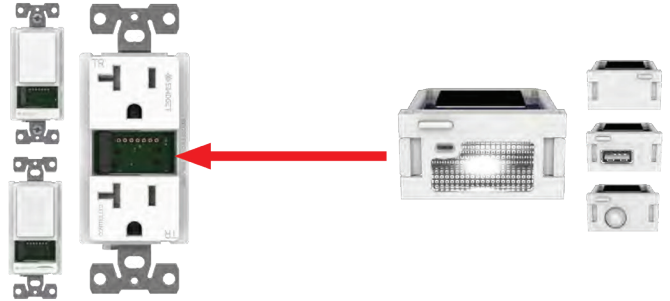

Swidget Devices without Inserts

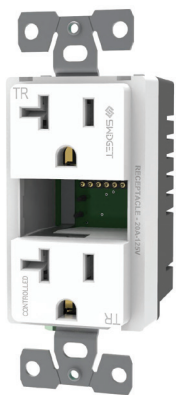

Swidget Outlet w/o Insert (Insert on Next Page)

- Independent power monitoring for each of the (2) receptacles with Wi-Fi enabled insert (sold separately) and the Swidget App
- **Top receptacle** is always “on” and allows for wireless power monitoring
- **Bottom receptacle** allows for wireless “on/off” control and power monitoring
- Fits all electrical boxes 3” x 2” x 2.5” and larger
- Tamper resistant shutters for safe operation
- Neutral wire required for installation
- Electrician required for install, works with all standard rocker switch plates (not included)



Item #	Quick Code	Description	Color
RVR1020SWA	T922	120VAC 20A Swidget Outlet, w/o Insert	White



Swidget On/Of Switch w/o Insert (Insert on Next Page)

- Single pole and 3-way wiring compatible for lighting and fan applications
- Capability for scene programming with a Wi-Fi enabled insert (sold separately)
- 300W LED/CFL load rating
- Fits all electrical boxes 3” x 2” x 2.5” and larger
- Neutral wire required for installation
- Electrician required for install, works with all standard rocker switch plates (not included)



Item #	Quick Code	Description	Color
RVS16001WA	T921	120VAC 300W/600W Swidget On/Of Switch, w/o Insert	White



Swidget Dimmer Switch w/o Insert (Insert on Next Page)

- Unique on/off/dimmer control in a single pad with the capability for scene programming with a Wi-Fi enabled insert (sold separately)
- 150W LED/CFL load rating
- Compatible with all Tresco dimmable power supplies
- Fits all electrical boxes 3” x 2” x 2.5” and larger
- Neutral wire required for installation
- Electrician required for install, works with all standard rocker switch plates (not included)



Item #	Quick Code	Description	Color
RVSD3001WA	T920	120VAC 150W/300W Swidget Dimmer Switch, w/o Insert	White

TRESCO SWIDGET

Swidget Wi-Fi Inserts

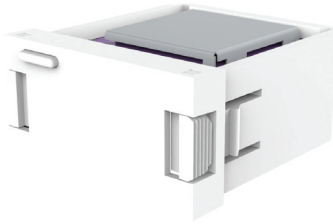

Swidget Wi-Fi Control Insert

- Wi-Fi Control Insert transforms a Swidget device into a smart device
- Control an outlet (lights, appliances or anything plugged in) from anywhere
- Wireless Band: 2.4GHz
- Device Compatability: Amazon Alexa, Google Assistant, IFTTT



Item #	Quick Code	Description	Color
RVWI000UWA	T923	Swidget Wi-Fi Control Insert	White

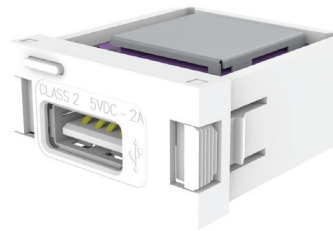

Swidget Wi-Fi Control + USB Charger Insert

- Type A USB connector to allow for fast-charging of your devices
- USB output up to a 2.0A rating
- Class 2 output certified
- Wireless Band: 2.4GHz
- Device Compatability: Amazon Alexa, Google Assistant, IFTTT



Item #	Quick Code	Description	Color
RVWI001UWA	T924	Swidget Wi-Fi Control + USB Charger Insert	White

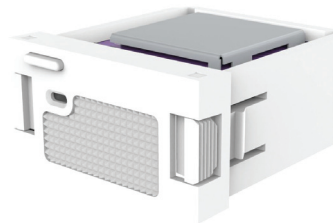

Swidget Wi-Fi Control + Guide/Night Light Insert

- Basic night light functionality with automatic light sensor trigger
- Warm white high efficient LED
- Wireless Band: 2.4GHz
- Device Compatability: Amazon Alexa, Google Assistant, IFTTT



Item #	Quick Code	Description	Color
RVWI002UWA	T925	Swidget Wi-Fi Control + Guide/Night Light Insert	White



Swidget Wi-Fi Control + Motion Sensor Insert

- Wireless Infrared Detection (PIR) Panasonic Motion Sensor
- Occupancy/Vacancy detection
- Vacancy timer adjustable between 1-60 minutes
- 120-degree detection angle with a 10' (3 m) detection range
- When connected to Wi-Fi, it can be used to create sensor-based automations, where motion or occupancy can trigger actions in switches, outlets, send notifications and more
- Automatically turns on lights when someone enters or turns of lights when no motion is detected
- Wireless Band: 2.4GHz
- Device Compatability: Amazon Alexa, Google Assistant, IFTTT



Item #	Quick Code	Description	Color
RVWI004UWA	T926	Swidget Wi-Fi Control + Motion Sensor Insert	White

A TRESCO 120 VOLT LED WALL DIMMERS

B
C
D
E
F
G
H
I
J
K
L
M
N
O
P
Q
R
S
T
U
V
W
X
Y



Lutron Diva C-L Dimmer
150 Watts



- Large paddle switch with a captive linear-slide dimmer for a standard designer wall plate opening
- Switch returns light to preset light level
- Offers more reliable dimming performance over standard dimmers
- HED technology with advanced dimming circuitry designed for compatibility with most high-efficiency light bulbs
- Adjustment switch to modify the minimum light level in order to maximize the dimming range if flickering occurs at lower dimming levels

Item #	Quick Code	Description
RVDVCL-153PH-WH	T321	150W Lutron Diva Dimmer without plate



Lutron Skylark Contour Diva C-L Dimmer
150 Watts



- On/off rocker switch with a captive linear-slide dimmer for a standard designer wallplate opening
- Switch returns light to preset light level
- Offers more reliable dimming performance over standard dimmers
- HED technology with advanced dimming circuitry designed for compatibility with most high-efficiency light bulbs
- Low-end adjustment dial

Item #	Quick Code	Description
RVCTCL-153P-WH	T320	150W Lutron Skylark Dimmer without plate



Leviton Decora LED Dimmer
300 Watts



- Large paddle switch with a captive linear-slide dimmer for a standard designer wall plate opening
- Packaged with White, Ivory, and Light Almond color change kits
- Switch returns light to preset light level
- No neutral wire required for installation
- Adjustment switch to modify the minimum light level in order to maximize the dimming range if flickering occurs at lower dimming levels

Item #	Quick Code	Description
RVDSL06-1LZ	T608	300W Leviton Decora Dimmer w/WH-IV-LA Color Kits

TRESCO® ACCESSORIES

**INSTALLATION SET-UP
FOR FREEDIM WIRELESS
CONTROLLERS**

**(Micro Dimmer,
Deco Wall Dimmer
& Multi-Zone
Remotes)**

FREEDIM
WIRELESS CONTROL



A

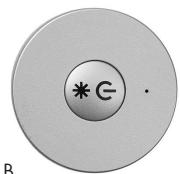

B



Micro Dimmer

- Single zone wireless dimmer
- Sleek Black or Nickel finish
- Easy to replace, long life lithium battery
- 65 ft. range of control from dimmer to receiver
- Mounting case can be mounted with screws or to a metallic surface
- A single dimmer can be programmed to up to 10 different receivers; a single receiver can be programmed to up to 8 different dimmers
- Required Component: Universal Receiver, must purchase to operate Micro Dimmers



C

Item #	Quick Code	Description
A RVWLD-1RND-BL	T494	0-100% Dim and On/Off Switch, Includes Lithium Battery (Type CR2025), Black Finish
B RVWLD-1RND-NI	T495	0-100% Dim and On/Off Switch, Includes Lithium Battery (Type CR2025), Nickel Finish
Required Component: Must purchase the Universal Receiver in order to operate the Micro Dimmer		
C RVWLD-1REC	T496	60 Watts, 12VDC, Universal Receiver (Must purchase to operate Micro Dimmer)

A
B
C
D
E
F
G
H
I
J
K
L
M
N
O
P
Q
R
S
T
U
V
W
X
Y

TRESCO® ACCESSORIES



Deco Wall Dimmer

- Single & Two zone wireless dimmers
- Sleek Black, White or Light Almond finish
- Easy to replace, long life lithium battery
- 65 ft. range of control from dimmer to receiver
- Can be mounted to standard wall electrical boxes or directly to drywall
- A single dimmer can be programmed to up to 10 different receivers; a single receiver can be programmed to up to 8 different dimmers
- Required Component: Universal Receiver, must purchase to operate Deco Wall Dimmers

FREEDiM
WIRELESS CONTROL

tresco
lighting

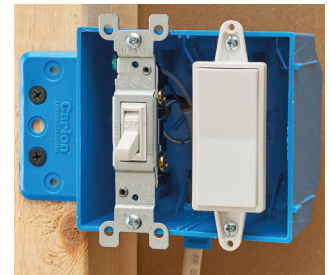
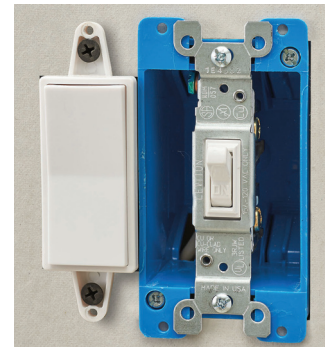
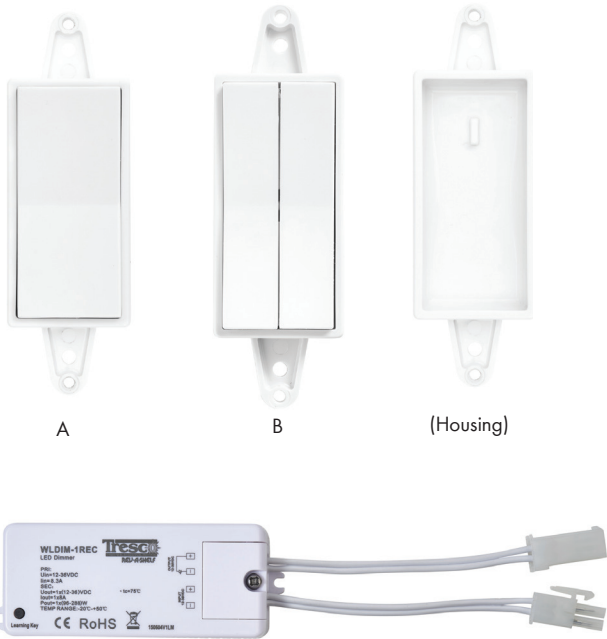

Item #	Quick Code	Finish
Single Zone - 0-100% Dim and On/Off Switch, Includes Lithium Battery (Type CR1620)		
A RVWLD-1WAL-WH	T530	White Finish
A RVWLD-1WAL-BL	T531	Black Finish
RVWLD-1WAL-AL	T532	Light Almond Finish
Two Zone - 0-100% Dim and On/Off Switch, Includes Lithium Battery (Type CR1620)		
B RVWLD-2WAL-WH	T541	White Finish
B RVWLD-2WAL-LA	T542	Light Almond Finish
Required Component: Must purchase the Universal Receiver in order to operate the Deco Wall Dimmer		
C RVWLD-1REC	T496	60 Watts, 12VDC, Universal Receiver (Must purchase to operate Deco Wall Dimmer)

TRESCO® ACCESSORIES

A
B
C
D
E
F
G
H
I
J
K
L
M
N
O
P
Q
R
S
T
U
V
W
X
Y



Multi-Zone Remote

FREEDIM
WIRELESS CONTROL

tresco
lighting

- Independent control of three lighting zones (respectively) from single remote
- Program additional Receivers to separate the lighting in a room into multiple Zones that you can control independently
- Set brightness levels of all of the Zones to a desired level then save as a "Scene"
- Integrated magnet allows for mounting to refrigerator or other metallic surfaces
- Includes: magnetic mounting tray that can be screw mounted
- 65 ft. range of control from remote to Receiver
- Required Component: Universal Receiver, must purchase to operate Multi-Zone Remote

	Item #	Quick Code	Description
A	RVWLD-3RMT-BL	T646	3-Zone Remote Dimmer, 0-100% Dim and On/Off Switch, Includes Magnetic Mounting Tray and Lithium Battery (Type CR2032)
Required Component: Must purchase the Universal Receiver in order to operate the Multi-Zone Remote			
B	RVWLD-1REC	T496	60 Watts, 12VDC, Universal Receiver (Must purchase to operate Multi-Zone Remotes)



A. 3-Zone Remote



B



Magnetic Mounting Tray

A TRESCO ACCESSORIES



A B

Wireless Door Sensor



- Allows light to be controlled by multiple doors
- Simple push-button pairing with receiver (sold separately)
- Program up to (4) sensors to a single receiver
- No cumbersome, messy wires to have to hide inside your cabinetry
- Mounting hardware (included)
- **Required Component: Wireless Door Sensor Receiver (see below)**

Item #	Quick Code	Description	Size	
A	RVWLDS-BL	T615	FREEDiM Wireless Door Sensor - Black Finish	1-13/16" Sq. x 5/8"H
B	RVWLDS-NI	T614	FREEDiM Wireless Door Sensor - Nickel Finish	1-13/16" Sq. x 5/8"H

J



Wireless Door Sensor Receiver



- 60W capacity (12VDC); 96W capacity (24VDC)
- Power failure memory
- Install inline between power supply and lights
- Simple one button pairing with Wireless Door Sensors
- Single receiver can be programmed with up to (4) sensors
- Allows for up to 4 doors to control the same light fixtures
- **Required component for Wireless Door Sensors**

Item #	Quick Code	Description	Size
RVWLDSREC	T616	12/24VDC Wireless Door Sensor Receiver	1-3/8"W x 7/8"H x 3-1/4"L

K

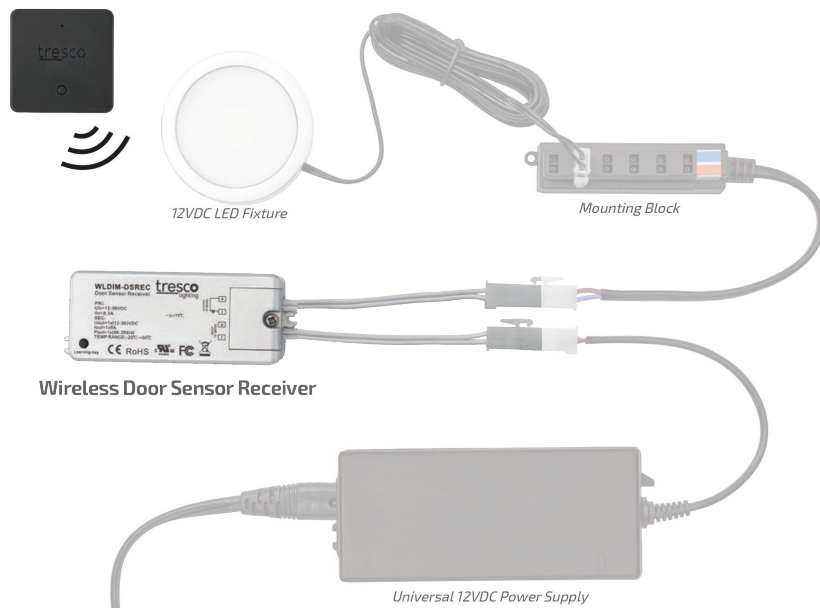

TRESCO® ACCESSORIES

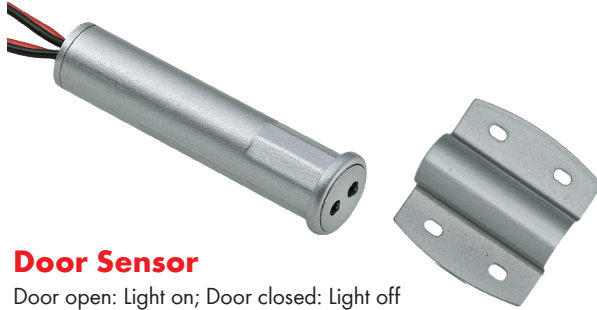

Door Sensor

Door open: Light on; Door closed: Light off

- Max wattage: 60W
- Sensor range: 2" (50 mm)
- Cable input: 79" (2 m)
- Cable output: 6" (152 mm)
- Finish: Nickel/Black

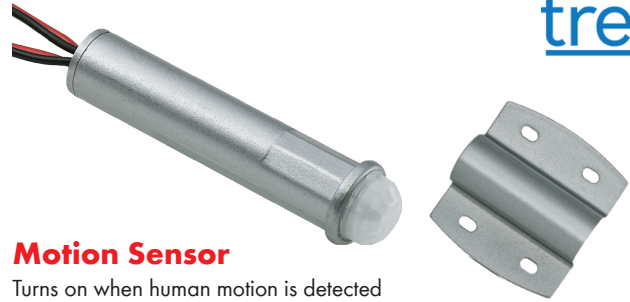

Motion Sensor

Turns on when human motion is detected

- Max wattage: 60W
- Sensor range: 0-5' (1500 mm)
- Viewing degree: 100°
- Time on: 30 secs if no motion
- Cable input: 79" (2 m)
- Cable output: 6" (152 mm)
- Finish: Nickel/Black

Touch Dimmer Sensor

Touch on/off and 1-100% dimming control

- Max wattage: 60W
- Cable input: 79" (2 m)
- Cable output: 6" (152 mm)
- Finish: Nickel/Black
- * Hold finger down for dimming

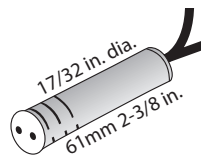
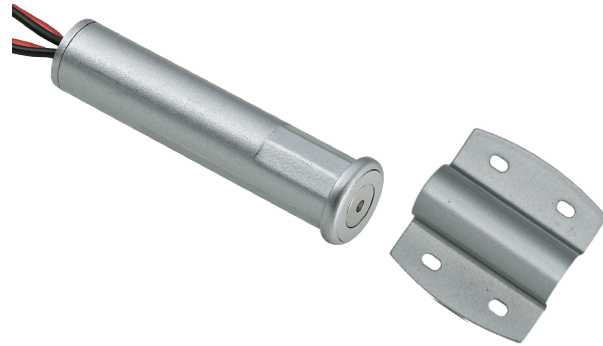

Door Sensor

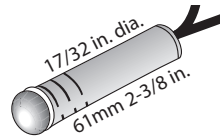

Motion Sensor

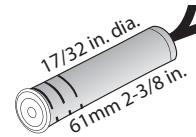

Touch Dimmer Sensor

12VDC Oval Controllers, 27W Recess/Surface Mount

Item #	Quick Code	Description
RVLED-OVLDS-BL	T387	Door Sensor, Black Finish
RVLED-OVLDS-NI	T354	Door Sensor, Nickel Finish
RVLED-OVLMS-NI	T355	Motion Sensor, Nickel Finish
RVLED-OVLTD-NI	T357	Touch Dimmer Sensor, Nickel Finish

A
B
C
D
E
F
G
H
I
J
K
L
M
N
O
P
Q
R
S
T
U
V
W
X
Y

A TRESKO® ACCESSORIES

B 12VDC Remote Control Dimmers

Remote Control LED Dimmers feature radio-frequency, remote-control dimming to adjust lights from anywhere in the room up to 30' (9 m). The remote control provides on/off power and dims lights from 100%-1%.



C Universal Remote Dimmer

- Controls up to 5A/60W of LED lighting
- Features a built-in memory that recalls the last setting when turned on
- Comes with two remote controls (one extra, as a backup)
- No line of sight required
- Can control multiple dimmers in same room with single remote control for universal dimming

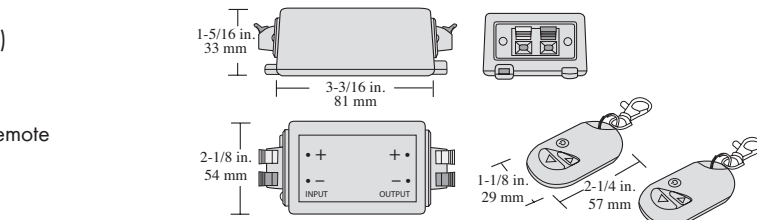

D Dedicated Remote Dimmer

- Controls up to 5A/60W of LED lighting
- Features a built-in memory that recalls the last setting when turned on
- No line of sight required
- Comes with two remote controls (one extra, as a backup) that are synchronized to control the same dimmer
- Can use multiple independently controlled dimmers in the same room

***Recommended not to exceed 3 per room**

Placement of multiple dimmers in a room may be critical for proper function depending on set-up and obstacles.

Item #	Quick Code	Description
RVLEDDIMRMT-12V8A	T148	LED Dedicated Dimmer
RVLEDDIMRMT-12V8AU	T149	LED Universal Dimmer

Both models of the Remote Control LED Dimmer provide on/off power and dim lights from 100%-1%. The dedicated Remote Control independently controls one specific dimmer in a room. The Universal Remote Control (U) controls multiple dimmers in a room.

R 12VDC Manual In-Line Rotary Dimmer



- 4A/48W capacity
- 100-0% dimming and on/off power
- 79" (2 m) input lead snaps into power supply mounting block with male AMP® connector
- 8" (203 mm) output connects to run of light with female AMP® connector

Item #	Quick Code	Description
RVLED-DIMCON-BL	T114	LED Black Inline Rotary Dimmer, 12VDC 48W
RVLED-DIMCON-WH	T115	LED White Inline Rotary Dimmer, 12VDC 48W

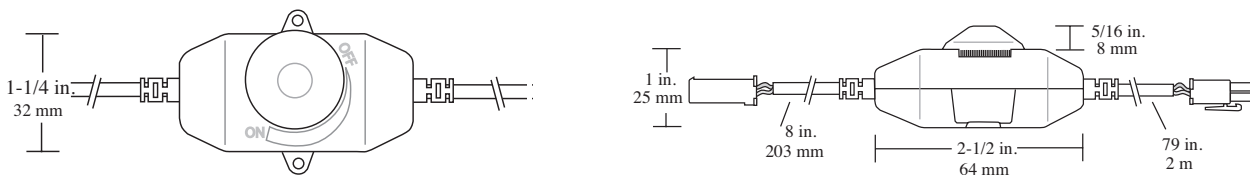

TRESCO® ACCESSORIES

Round Switch - 12V

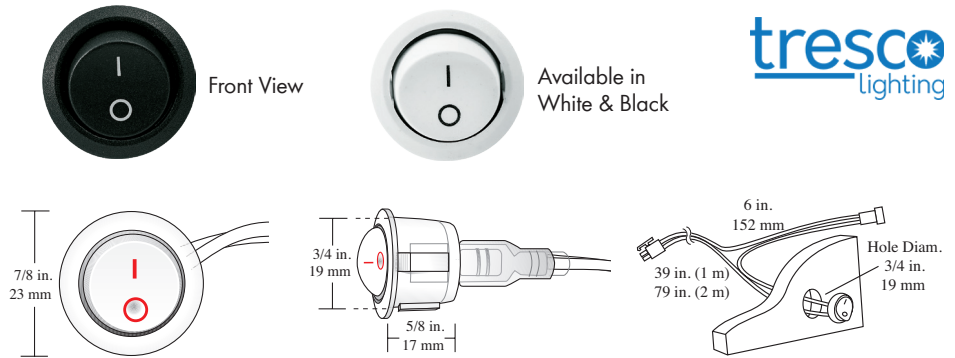

Item #	Quick Code	Description
RVRDSW-2M-BL	T167	Black Rocker Switch w/ 79" (2 m) Lead, 12VAC/DC
RVRDSW-2M-WH	T168	White Rocker Switch w/ 79" (2 m) Lead, 12VAC/DC

3/4" (19mm) hole required.

Starter/Extension Cord



- Low-voltage wire
- Used to extend the starter leads for any Tresco 12VDC lights
- Eight lengths to choose from

Item #	Quick Code	Description
RVLED-LINKD-8	T351	3" (8 cm) 12VDC Starter/Link/Extension Cord
RVLED-LINKD-15	T844	6" (15 cm) 12VDC Starter/Link/Extension Cord
RVLED-LINKD-25	T194	10" (25 cm) 12VDC Starter/Link/Extension Cord
RVLED-LINKD-60	T195	24" (60 cm) 12VDC Starter/Link/Extension Cord
RVLED-LINKD-120	T203	48" (120cm) 12VDC Starter/Link/Extension Cord
RVLED-LINKD-180	T190	72" (180cm) 12VDC Starter/Link/Extension Cord
RVLEDLINKD-245	T447	96" (245 cm) 12VDC Starter/Link/Extension Cord

Hole size: 1/2" (13 mm) required

Dual USB Charging Station



Installation Set-Up

- USB charging station ties into Tresco power supplies
- Max. load capacity = 1 port x 2.1 Amp or 2 ports x 1.05 Amp
- 79" start cord is attached
- Two interchangeable face plates included (Black & Nickel)
- Draws 10W at max capacity while charging
- Has auto shut-off
- Size: 28mm (1-7/64") Diameter Body x 32mm (1-1/4") Height
- Face Plate Size: 37mm (1-29/64")

Item #	Quick Code	Description
RVHUSB2-BLNI	T528	USB Charging Station w/2 Ports, Recess Mounted, 79" Wire, Black or Nickel Finish

A TRESKO® INSTALL ACCESSORIES

B
C
D
E
F
G
H
I
J
K
L
M
N
O
P
Q
R
S
T
U
V
W
X
Y

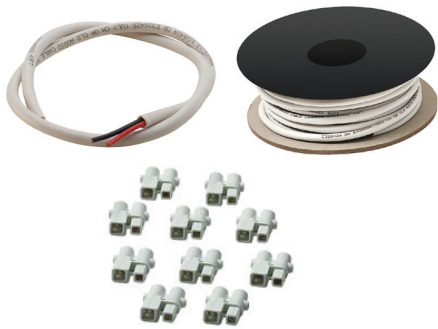

Class 2, 16 Gauge Wire & Barrel Connectors



- Rated for low-voltage in-wall use
- 16 Gauge Wire & Barrel Connectors are designed to be used together

Item #	Quick Code	Description
RV16CL2-WH50	T836	50' Roll, 16 AWG 12V Class 2 Wire, White Finish
RVLED-WCON-WH-5	T305	12V DIY Barrel Connectors, White Finish, (10 Per Bag)



VHB Tape

- Automotive grade VHB
- Used to mount all light fixtures
- Used as a base layer for mounting Tape LED products

Item #	Quick Code	Description
RVVHBTPPE-1134	T480	7/16"W x 111-1/2"L VHB Adhesive Tape Roll



Plastic Channels for Wire Management



- Fits all of Tresco's wires
- Easy cut-to-size in field
- Durable adhesive mounting
- Size: 9/32"W x 15/32"D x 60"L

Item #	Quick Code	Description
RVWM5-BL-1	T417	60"L Plastic Channel for Wire Management, Black Finish
RVWM5-BR-1	T482	60"L Plastic Channel for Wire Management, Brown Finish
RVWM5-WH-1	T418	60"L Plastic Channel for Wire Management, White Finish
RVWCLP-WH	T607	Wire Management Adhesive Clips, White Finish (10 Per Bag)

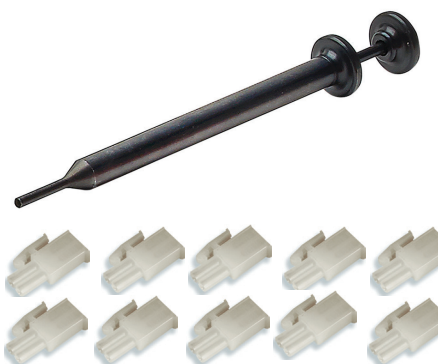

Extraction Tool & AMP Connectors



- Extraction Tool safely removes AMP Connectors

Item #	Quick Code	Description
RVPINEXT-1	T557	Extraction Tool, Removes AMP Connctors
RVMALE-AMP	T346	AMP Connectors (10 Per Bag)

8W & 15W SNAP PANELS

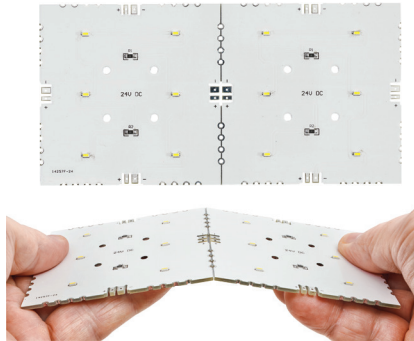

8W & 15W Snap Panels

- **8W Snap Panel:** 900 Lumens Per Sq. Foot, 50,000 Hrs of Lamp Life
- **8W Snap Panel:** 8 Watts Per Sq. Foot, 0.5 Watt Per 3" Square
- **15W Snap Panel:** 1,670 Lumens Per Sq Foot, 50,000 Hrs of Lamp Life
- **15W Snap Panel:** 15 Watts per Sq. Ft, 0.94 Watt Per 3" Square
- 120° Beam Spread
- Size of Individual Panel: 3"H x 3"W x 1/16" Thick
- Warm White (3000K), Natural (4000K)
- Cool White (5000K), and Daylight (6500K)
- Sold in: 12" x 12" squares
- Plastic clips and screws are included with each panel for mounting purposes



8W Snap Panel Item #	Quick Code	15W Snap Panel Item #	Quick Code	Description
RVSP8WA-30K	T558	RVSP15WA-30K	T837	24VDC, LED Snap Panel, 3000K, Warm White, Includes Mounting Screws & Clips
RVSP8WA-40K	T559	RVSP15WA-40K	T838	24VDC, LED Snap Panel, 4000K, Natural, Includes Mounting Screws & Clips
RVSP8WA-50K	T560	RVSP15WA-50K	T839	24VDC, LED Snap Panel, 5000K, Cool White, Includes Mounting Screws & Clips
RVSP8WA-65K	T561	RVSP15WA-65K	T840	24VDC, LED Snap Panel, 6500K, Daylight, Includes Mounting Screws & Clips

Required Items	Item #	Quick Code	Description
	RV24DCELT96	T577	24VDC 96W, Power Supply with 5-Barrel Connectors
	RVSPPKT-305MM	T562	12"L Snap Panel Starter Lead
	RVSPPKT-1M	T563	39"L Snap Panel Starter Lead
	RVSPPKT-3M	T564	118"L Snap Panel Starter Lead

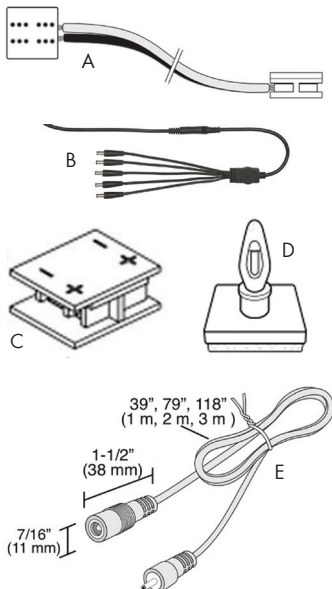

Optional Items			
	Item #	Quick Code	Description
A	RVSPLNK8	T568	3" Snap Panel Linking Cord
	RVSPLNK25	T569	10" Snap Panel Linking Cord
	RVSPLNK60	T570	24" Snap Panel Linking Cord
	RVSPLNK120	T571	48" Snap Panel Linking Cord
B	RV1BRL5	T574	Extra 5-Barrel Connectors
C	RVSPBTB10-10	T581	Snap Panel Back-To-Back Link, 10 Per Pack
D	RVSPCLP6	T573	Extra Snap Panel Mounting Clips, 6 Per Pk
E	RVSPEXT-1M	T565	39" Snap Panel Starter Lead Ext.Cord
	RVSPEXT-2M	T566	79" Snap Panel Starter Lead Ext. Cord
	RVSPEXT-3M	T567	118" Snap Panel Starter Lead Ext.Cord



A
B
C
D
E
F
G
H
I
J
K
L
M
N
O
P
Q
R
S
T
U
V
W
X
Y

A TRESKO® POCKIT® 120-M



Specifications:

- Lumens: 270
- Lamp Life: 30,000 Hours
- Mounting: Recess/Surface
- Warranty: 3 years
- Beam Angle: 100°
- Link up to 45 fixtures

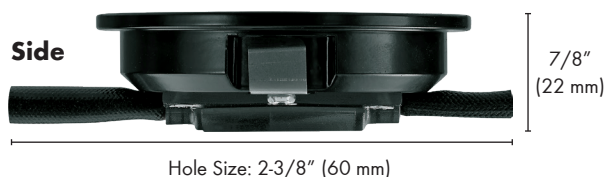

Item #	Quick Code	Description
120V, 4W Pockit 120-M LED Puck, Non-Linkable, 9" Input Cord, 3000K		
RVMPOC4W120NLWBL	T814	Black Finish
RVMPOC4W120NLWNI	T815	Nickel Finish
RVMPOC4W120NLWWH	T816	White Finish
120V, 4W Pockit 120-M LED Puck, Linkable, 9" Input Cord & Output Cord, 3000K		
RVMPOC4W120LWBL	T451	Black Finish
RVMPOC4W120LWNI	T452	Nickel Finish
RVMPOC4W120LWWH	T453	White Finish
96" Starter Cord, plugs into wall outlet		
RVMPOC-PKT8-BL	T454	Black Finish
RVMPOC-PKT8-WH	T455	White Finish

Optional Items				
Black Finish Item #	Quick Code	White Finish Item #	Quick Code	Description
RVRDSW2M120BL	T817	RVRDSW-2M-120-WH	T311	Rocker Switch with 79" Cord
RVFPOCLINKA-25-BL	T818	RVFPOC-LINKA-25	T333	10" Linking Cord
RVFPOCLINKA-60-BL	T104	RVFPOCLINKA-60-WH	T105	24" Linking Cord
RVFPOCLINKA120-BL	T106	RVFPOCLINKA120-WH	T107	48" Black Linking Cord
RVFPOCLINKA180-BL	T108	RVFPOCLINKA180-WH	T109	72" Black Linking Cord
RVHWBBLT5S1	T819	RVHWBWHT5S1	T820	Hardwire Box with Switch

COUNTERTOP DISPLAYS

A
B
C
D
E
F
G
H
I
J
K
L
M
N
O
P
Q
R
S
T
U
V
W
X
Y



Option A:
Equiline Tape / Puck

- 1.5W 2700K Equiline Tape LED
- 3W 4800K Equiline Tape LED
- Equiline Puck 3000K
- FREEDiM Wireless Micro Dimmer

Item #: RVLKDCDA-1



Option B:
Fineline / Equiline Puck

- Fineline 3000K
- Fineline 5000K
- Equiline Puck 3000K
- FREEDiM Wireless Micro Dimmer

Item #: RVKDCDB-1



Option C:
Premium Flex Tape

- 1.5W 2700K FlexTape
- 3W 3500K FlexTape
- 4.4W 4800K FlexTape
- 5.5W 6500K FlexTape
- FREEDiM Wireless Deco Dimmer

Item #: RVKDCDC-1



Option D:
Premium Variety

- Eurolinx 3000K
- SimpLED 2.0 5000K
- 3W Power Pockit® 3000K
- FREEDiM Wireless Deco Dimmer

Item #: RVKDCDD-1



Option E:
Premium Linear / Puck (1)

- Eurolinx 3000K
- Eurolinx 5000K
- 3W Power Pockit® 3000K
- FREEDiM Wireless Deco Dimmer

Item #: RVKDCDE-1



Option F:
Premium Linear / Puck (2)

- SimpLED 2.0 3000K
- SimpLED 2.0 5000K
- 3W Power Pockit® 3000K
- FREEDiM Wireless Deco Dimmer

Item #: RVKDCDF-1

A PUCK LIGHT JIG



Can also be used to hide wiring for strip lights and switches.

Revolutionary design eliminates false bottom/cabinet build-ups!



Most cabinetmakers know that the installation of under mount cabinet lighting in upper cabinets or shelves typically requires a "false bottom" or "build up" to hide the wire for the light. **Not Anymore!** TP Tools light jig easily and accurately eliminates false bottoms. Conceal wires directly in the cabinet bottom or shelf. Now you can install a puck light, strip light, switch or whatever you can think of in 3/4" or 5/8" material using this patented 3/8" wire concealing kit!

Includes: 12" x 3/8" drill bit, 2-1/8" and 2-1/4" Forstner bits with depth stops and blow molded case. Requires 1/2" hand drill for installation.



Item #
TP-PLJ



Bushings are backed with a lifetime warranty.

NOTE: Other size set-ups (35mm, 55mm and 68mm) and 18" drill bits also available (sold separately). Please contact your Würth Louis and Company Representative for additional information.

TRESCO FREE LIGHTING LAYOUT ASSISTANCE!

Because application of LED lighting is new to many design professionals, Tresco is now offering Lighting Layout Assistance to help specify Tresco products for both residential and commercial lighting design projects. trescolighting.com/lighting-layout-request

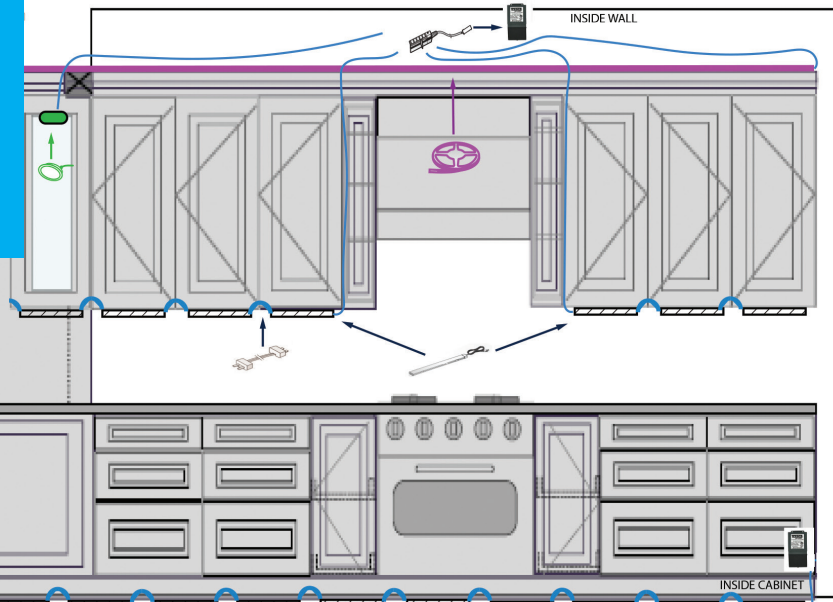

FlexTape



Power Supply



Wall Dimmers



Starter Cords



Link Connector



SimplLED



SimplLED Connector