

**SECTION U - TABLE OF CONTENTS**

**Section U Contents:**

Face Frame & Spring Clamps..... 2  
 Pipe Clamps..... 3  
 Bar Clamps..... 4  
 Clamps/Spreaders..... 5  
 I-Beam Clamps ..... 6  
 Band/Strap & Toggle Clamps..... 7  
 Files & Accessories..... 8-10  
 Trimmers..... 11  
 Laminate & Edgebanding Tools ..... 12-13  
 Cutting Tools..... 14-15  
 Scraping & Marking Tools..... 16  
 Marking & Measuring Tools..... 17  
 Tape Measures..... 18-19  
 Installation Jigs..... 20-23  
 3rd Hand Supports ..... 24  
 Hammers & Nail Sets..... 25  
 Würth Hand Tools..... 26-86



A  
B  
C  
D  
E  
F  
G  
H  
I  
J  
K  
L  
M  
N  
O  
P  
Q  
R  
S  
T  
U  
V  
W  
X  
Y



**A FACE FRAME & SPRING CLAMPS**

B  
C  
D  
E  
F  
G  
H  
I  
J  
K  
L  
M  
N  
O  
P  
Q  
R  
S  
T  
U  
V  
W  
X  
Y

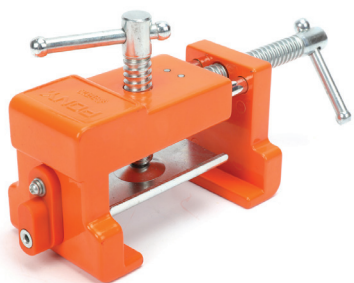

**Pony® Cabinet Claw, Face Frame Clamp**

**PONY JORGENSEN**

- Combines the multiple steps of face frame cabinet installation into one easy process
- Installs two stiles from 1-1/2" to 2" width and up to 1-1/2" thickness (each) with 4" opening capacity
- Protective rubber pads on clamp faces and alignment plate to cushion and protect cabinets
- Aluminum claws and alignment plate

Item #	Description
JP8511	Cabinet Claw (1 Clamp Pack)
JP8510	Cabinet Claw (2 Clamp Pack)



**Pony® Spring Clamps**

**PONY JORGENSEN**

- One of the most durable clamps available
- Non-slip jaws become parallel at maximum opening capacities
- Light weight, zinc plated steel jaws

Item #	Clamping Capacity	Throat Depth
JP3201-HT	1"	1-1/4"
JP3202-HT	2"	2"
JP3203-HT	3"	3"
JP3204-HT	4"	4"



**Steel Spring Clamps**



- With vinyl tips and handles
- Vinyl tips prevent marring and vinyl handles offer a non-slip grip
- Features a heavy duty spring for a tight fit and nickel plating to prevent corrosion

Item #	Clamping Capacity	Throat Depth
AKXM5	2"	2-1/4"
AKXM7	3"	3-5/16"



**3 Way Clamp**



- Non-marring rubber tips
- Spring clamp and edge clamp in one
- Approximately 30 lb of edge pressure
- Great for all types of edgebanding and general clamping purposes

Item #	Clamping Capacity	Throat Depth
FC3WAYCLAMP	2-1/2"	1-1/2"



**PIPE CLAMPS**

A  
B  
C  
D  
E  
F  
G  
H  
I  
J  
K  
L  
M  
N  
O  
P  
Q  
R  
S  
T  
U  
V  
W  
X  
Y

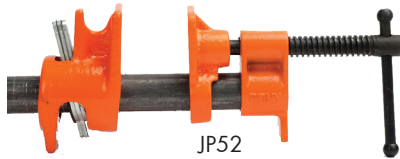

JP52

**Pony® Pipe Clamp, Traditional Style**

**PONY | JORGENSEN**

- Multiple-disc-clutch design allows secure
- Hold at any point along pipe
- Clamping capacity only limited by length of pipe used (\*not included)



JP50

Item #	Handle Style	Black Pipe Diameter*
JP52	Sliding Pin	1/2"
JP50	Crank-Type	3/4"



**Associated Item:**

- Clamp pads for protecting work
- Includes: (4) U-Shaped Pads

Item #
JP7456



**Pony® Pipe Clamp, H-Style**

**PONY | JORGENSEN**

- Wider and taller stance, taller and wider jaws than traditional style
- Clamping jaws are 2-1/8" and clamps sit 2-1/2" above work surfaces
- Multiple-disc-clutch design allows secure hold at any point along pipe (\*not included)
- Built in clamp hanger feature

Item #	Handle Style	Black Pipe Diameter*
JP55	Crank-Type	3/4"

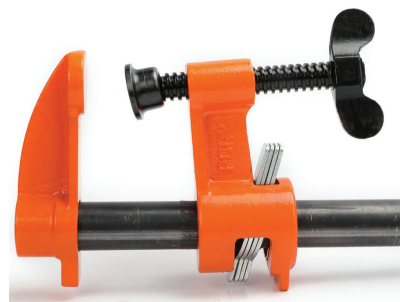

**Pony® Pipe Clamp, Deep Reach Style**

**PONY | JORGENSEN**

- 2-1/2 inch deep reach design
- Heads reverse to use as spreader clamp
- Multiple-disc-clutch design allows secure hold at any point along pipe
- Clamping capacity only limited by length of pipe used (\*not included)

Item #	Handle Style	Black Pipe Diameter*
JP56	Wing Nut	3/4"



**Pipe Clamp, Traditional Style**

- High base improves clearance from the work surface
- Virtually limitless clamping capacity determined by the length of pipe used (\*not included)

Item #	Black Pipe Diameter*
AKPC12-2	1/2"
AKPC34-2	3/4"

**A BAR CLAMPS**

B  
C  
D  
E  
F  
G  
H  
I  
J  
K  
L  
M  
N  
O  
P  
Q  
R  
S  
T  
U  
V  
W  
X  
Y



**Jorgensen® Steel Bar Clamps**

**PONY JORGENSEN**

- Cold-drawn steel screw with special, smoothly cut acme threads
- Multiple-disc clutch - three hardened, plated steel clutch discs and one clutch spring
- Strong, lightweight steel bars are rust-resistant
- Pony® Jorgensen's® own 'multiple-disc-clutch' holds securely at any point along the bar
- Protective pads keep your project free from marring

Item #	Clamping Capacity	Throat Depth	Clamping Force
<b>Medium Duty</b>			
JP3706	6"	2-1/2"	600 lb
JP3712	12"	2-1/2"	600 lb
JP3718	18"	2-1/2"	600 lb
JP3724	24"	2-1/2"	600 lb
JP3730	30"	2-1/2"	600 lb
JP3736	36"	2-1/2"	600 lb
<b>Heavy Duty</b>			
JP3706-HD	6"	3"	1,000 lb
JP3712-HD	12"	3"	1,000 lb
JP3718-HD	18"	3"	1,000 lb
JP3724-HD	24"	3"	1,000 lb
JP3730-HD	30"	3"	1,000 lb
JP3736-HD	36"	3"	1,000 lb



**Associated Item:**

- Clamp pads for protecting work
- Includes: (4) round pads and (4) U-Shaped Pads
- For use with JP3700 Series Medium Duty clamps only

<b>Item #</b>
JP7437

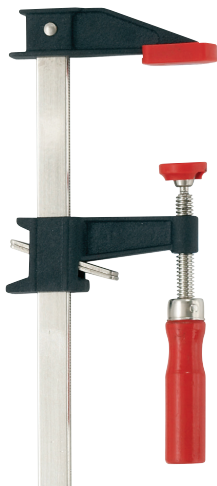

**Clutch Style Bar Clamps**



- Cast iron jaws - Durable powder coated cast-iron fixed and sliding jaws
- Secure - 2 piece slip-clutch plates keep the jaw sturdy and in place
- Protective pads - Non-marring pads on the top and bottom jaws

Item #	Clamping Capacity	Throat Depth	Clamping Force
AKGSCC2.506	6"	2-1/2"	600 lb
AKGSCC2.512	12"	2-1/2"	600 lb
AKGSCC2.518	18"	2-1/2"	600 lb
AKGSCC2.524	24"	2-1/2"	600 lb
AKGSCC2.530	30"	2-1/2"	600 lb
AKGSCC2.536	36"	2-1/2"	600 lb



## CLAMPS/SPREADERS

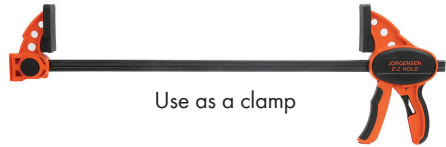

Use as a clamp

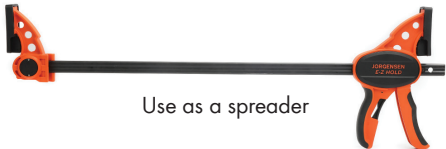

Use as a spreader



Join 2 clamps together to make a clamp with more than double the opening capacity of a single clamp!

### Jorgensen® E-Z HOLD Medium Duty Spreader/Clamps Expandable

**PONY JORGENSEN**

- The contoured comfort grip and quick release lever make it simple to get a firm grip fast
- Can easily be converted into spreader clamps
- Exclusive patented feature allows 2 clamps to be joined together to make a clamp with more than double the opening capacity of a single clamp

Item #	Clamping Capacity	Spreading Capacity	Throat Depth	Clamping Force
JP33406	6"	12-1/2"	3-1/3"	300 lb
JP33412	12"	18-1/2"	3-1/3"	300 lb
JP33418	18"	24-1/2"	3-1/3"	300 lb
JP33424	24"	30-1/2"	3-1/3"	300 lb
JP33436	36"	42-1/2"	3-1/3"	300 lb



### One-Handed Clamps, Clamping and Spreading



- Single-handed clamping and spreading of workpieces up to 445 lb clamping force
- Upper section can quickly convert from clamping to spreading without tools
- Ergonomic handle positioned behind the rail, enabling a powerful grip
- Soft pressure caps optimize material protection and secure clamping
- EZS clamps extend throat depth right to the outside edge of the pads

Item #	Clamping Capacity	Spreading Capacity	Throat Depth	Clamping Force
<b>445 lb Clamping Force</b>				
AKEZS15	6"	14"	3-1/2"	445 lb
AKEZS30	12"	20"	3-1/2"	445 lb
AKEZS45	18"	25-3/4"	3-1/2"	445 lb
AKEZS60	24"	31-3/4"	3-1/2"	445 lb
AKEZS90	36"	43-1/2"	3-1/2"	445 lb



Use to clamp, spread or lift!

### The Jack™, Clamp/Spread/Lift



- Great for lifting base cabinets to install shims or adjust leg levelers
- Spread up to 25", clamp up to 18"
- Lift up to 18" and 200 lbs.

Item #	Clamping Capacity	Throat Depth	Clamping Force
FCJACK	18"	2-1/4"	200 lb

**A I-BEAM CLAMPS**

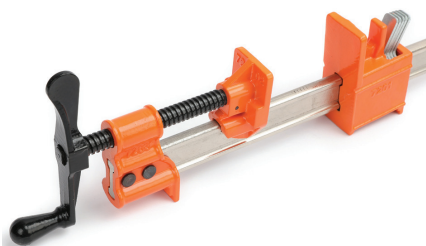

**Jorgensen® Steel I-Bar Clamp, Crank Handle**

**PONY | JORGENSEN**

- Heavy-duty steel bar clamps, with a resilient fixed-head design
- Bar size 1-1/2" x 7/16"
- Cold-drawn steel screw with special, smoothly cut acme threads
- Ductile cast iron castings, powder coated orange finish
- Capable of withstanding the rigorous daily demands of school shops, commercial woodworking operations, metalworking factories, welding applications and serious woodworking applications

**Associated Item:**

- Clamp pads for protecting work
- Includes: (4) U-Shaped Pads



Item #
JP7456

Item #	Clamping Capacity	Throat Depth	Clamping Force
JP7224	24"	1-3/4"	7,000 lb.
JP7230	30"	1-3/4"	7,000 lb
JP7236	36"	1-3/4"	7,000 lb
JP7248	48"	1-3/4"	7,000 lb
JP7260	60"	1-3/4"	7,000 lb
JP7272	72"	1-3/4"	7,000 lb
JP7284	84"	1-3/4"	7,000 lb
JP7296	96"	1-3/4"	7,000 lb

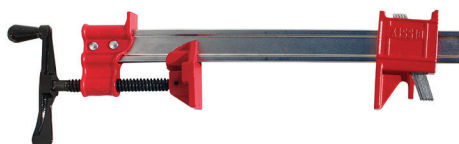

**I-Beam Clamp**



- Nickel plated rail resists corrosion
- Crank handle for tremendous strength and long term durability
- ACME threaded screws - With 9/16" spindle diameter
- Jaw Width: 1-3/4"; Bar Width: 1-3/8"; Bar Thickness: 7/16"

Item #	Clamping Capacity	Throat Depth	Clamping Force
AKIBEAM36	36"	2"	7,000 lb
AKIBEAM48	48"	2"	7,000 lb
AKIBEAM60	60"	2"	7,000 lb



## BAND & TOGGLE CLAMPS



### Pony® Rapid Acting Band Clamp, 15'

PONY JORGENSEN

- Perfect for awkward or irregular shaped clamping projects of odd shapes, including round, polygon or square
- Includes plastic non-marring 1 inch by 1 inch jaws allow for great fit on corners

Item #	Band Length x Width	Range of Angle
JP1225	15' x 1"	Up to 90°



### Strap Clamp, 23'



- Strap draws simultaneously from both sides ensuring pressure is applied equally on all corners without distortion
- Integrated rewind mechanism is operated with a crank handle which eliminates tangling and damage to the strap
- Vario clip corners with twin-tilting pressure pads auto-adjust from 60° to 180° for easy assembly of most multi-angle projects

Item #	Description	Band Length x Width	Range of Angle
AKVAS23	Strap Clamp with 6 Vario Corner Clips	23' x 1-1/2"	60° to 180°
AKVAC6	Vario Corner Clips (Set of 6)	-	60° to 180°



A

### Toggle Clamps, Auto Adjust



- Adjustable clamping force based on the adjusting screw in the joint
- Sturdy, tempered metal sheets for a long service life
- Base plate hole pattern suitable for millimeters and inches

	Item #	Clamping Capacity	Automatic Adjust	Norm Clamp Force Range	Holding Capacity
<b>Inline Toggle, Flanged Base Plate</b>					
A	AKSTC-IHH25	5/8"	1/2"	25 - 550 lb	700 lb
<b>Horizontal Toggle with Open Arm, Horizontal Base Plate</b>					
B	AKSTC-HH20	13/16"	3/4"	25-250 lb	450 lb
	AKSTC-HH50	1-9/16"	1-3/8"	25 - 550 lb	700 lb
	AKSTC-HH70	2-3/8"	1-3/8"	25 - 550 lb	700 lb



B

A  
B  
C  
D  
E  
F  
G  
H  
I  
J  
K  
L  
M  
N  
O  
P  
Q  
R  
S  
T  
U  
V  
W  
X  
Y

**A FILES**



**PLASTI-CUT® Duplex® Laminate Files**

**PLASTIC-CUT®**

- One side is a “fast cut” and the other side is a “mill cut”
- Wide body provides 10% more cutting surface
- One edge has no teeth for safe corner filing
- Rounded tang design is safer to use and it eliminates the need for a separate handle
- Supplied in protective sleeve to provide longer tool life

Item #	File Length
PC-8DX	8”
PC-10DX	10”



**PLASTI-CUT® FAST® Laminate Files**

**PLASTIC-CUT®**

- Designed and manufactured specifically for maximum performance on decorative laminates
- FAST® cut files provide a coarse finish
- Supplied in protective sleeve to provide longer tool life

Item #	File Length
PC-10F	10”
PC-12F	12”
PC-14F	14”



**PLASTI-CUT® Mill Laminate Files**

**PLASTIC-CUT®**

- Designed and manufactured specifically for maximum performance on decorative laminates
- Mill cut files provide a smooth finish
- Supplied in protective sleeve to provide longer tool life

Item #	File Length
PC10M	10”
PC12M	12”
PC-14M	14”



**FILES**

A  
B  
C  
D  
E  
F  
G  
H  
I  
J  
K  
L  
M  
N  
O  
P  
Q  
R  
S  
T  
U  
V  
W  
X  
Y



**Laminate Files, Economy Flat Multi-Kut®**



- Combines the performances of Flat and Mill Files
- Obtain almost any required finish simply by changing the feed pressure
- Multi-Kut® Flat Files are single-cut coarse tooth files that taper toward the point in width
- Features a diamond pattern “double chip-breaker” allowing for fast stock removal while leaving a smooth finish

NOTE: 12” files come unsleeved from the manufacturer.

Item #	File Length
PC-SM10FM	10”
PC-SM12FM	12”



**All-Purpose Files**



- Double cut on one side for quick removal and rough work; single cut on the other for finish filing

Item #	File Length
PC-SM10AP	10”



**Mill Laminate Files**



- Designed for use on decorative laminates
- Mill cut files provide a smooth finish

Item #	File Length
PC-SM10MC	10”
PC-SM12MC	12”



**All Purpose Files, Black Maxi-Sharp®**



- Built-in handle provides maximum versatility
- Double cut on one side and a single cut on the other side
- One edge cut and one edge safe (uncut) for shoulder filing

Item #	File Length
PC8AP	8”
PC10AP	10”

**A FILE ACCESSORIES**



**File Card**

- Sharp tempered steel bristles are angled forward, aligned and spaced for good effective cleaning
- Not recommended for use on PLASTIC-CUT® files

PRACTICAL PRODUCTS

Item #	Length	Type
PC-FC87	8-1/2"	Standard Duty
PC-FC87B	10"	Heavy Duty



**Wire Brush**

- Recommended for cleaning PLASTI-CUT files to preserve tooth sharpness
- For files that are clogged with adhesive, soak in Würth Pitch & Resin Remover (see below), then use the wire brush

PRACTICAL PRODUCTS

Item #	Overall Length
PC-WB42	14"



**File Card/Brush**

- Use brush side for general cleaning and card side for stubborn cleaning
- Sharp tempered steel bristles of the card side are angled forward, aligned and spaced for good effective cleaning
- Wire side NOT recommended for use on PLASTIC-CUT® file

PRACTICAL PRODUCTS

Item #	Length
PCCB88	10"



**Pitch & Resin Remover, Eco Friendly**

- Designed to quickly dissolve and emulsify materials from your files

Item #	Size
WR0893011201	1 Qt., Ready to Use
WR0893011135	1 Gal, 1:10 Dilution



**TRIMMERS**

A  
B  
C  
D  
E  
F  
G  
H  
I  
J  
K  
L  
M  
N  
O  
P  
Q  
R  
S  
T  
U  
V  
W  
X  
Y



**End Nippers™**

- Trims flush with the surface
- Can be used in a variety of different applications, including trimming the edge of edgebanding/veneers and soft metals
- Will even work on 3mm edgebanding
- Not meant for use on nails



<b>Item #</b>
FCENDNIP



**Mirco Flush Cut Trimmers™**

- Rounded flush side cutting surface design allows you to get into tight spots when removing brad nails or small slivers
- Gently pull the nail out by rolling the micro flush cut pliers without marring or denting the wood



<b>Item #</b>
FCPLIERSMICRO



**Macro Flush Cut Trimmer™**

- For making micro-cuts for "nip and tuck" of edgebanding and laminate
- Works with standard wood and PVC edgebanding .018 - .025, not recommended for 3mm



<b>Item#</b>
FCPLIERSFC



**Heavy Duty Flush Cut Trimmers™**

- Can be used to cut nails flush
- Comes with 2 FCPOWERMAG magnets to keep the cut item from flying through the air



<b>Item #</b>
FCPLIERSHD

**A LAMINATE/EDGEBANDING TOOLS**

**B**  
**C**  
**D**  
**E**  
**F**  
**G**  
**H**  
**I**  
**J**  
**K**  
**L**  
**M**  
**N**  
**O**  
**P**  
**Q**  
**R**  
**S**  
**T**  
**U**  
**V**  
**W**  
**X**  
**Y**



**Straight Handle J-Roller**

- 3"W rubber roller is soft enough to avoid marring, but firm enough to smooth out all covering materials

**PRACTICAL PRODUCTS**

Item #	Handle Length
PC-JR-78C	12"



**Extension Roller**

- Three 2-1/4" resilient rollers let you cover a lot of territory in a hurry
- Useful for decorative laminate, vinyl, or other adhesive-applied coverings
- With the preferred loop handle grip at the roller section, heavy pressure can be applied right where it is needed - at the rollers
- Twist-lock handle quickly adjusts from 18" to 27"

**PRACTICAL PRODUCTS**

Item #	Handle Length
PCER	18" - 27"



**Speedroller™**

- Ergonomically designed with laminate rollers that can be used in any PSA application
- Non-marring rubber wheels or maximum PSI steel wheels

**FastCap®**

Item #	Description
FCSPPEEDROLLERQUAD	Maximum PSI Steel, Non-Interchangeable
FCROLLERPRO	1 set Maximum PSI Steel and 1 set Non-Marring Rubber, Interchangeable



**LAMINATE/EDGEBANDING TOOLS**



**FastBreak™ Sander**



- Uniformly break the edge in sharp melamine, edgebanding, plywood and hardwood materials in just one pass
- FastBreak XL is designed for sanding entry doors and larger panel stock
- Extra sandpaper is stored inside and is easily accessed through removable end caps

Item #	Description	Material Thickness
FCFB	Sander	1/4" - 1"
FCFBXL	Sander	3/4" - 2-3/8"
FCFB80	Sandpaper, 80 Grit (Pack of 10)	-
FCFB180	Sandpaper, 180 Grit (Pack of 10)	-



**Pneumatic Edgeling Quad Trimmer™**



- No springs to lose when taking tool apart to trim one side of material
- Available tungsten carbide blades last 10 times longer than steel blades
- Trims both directions, both sides, top and bottom at once



Item #	Description	Blade Type
FCQTRIM	Standard Trimmer	Carbon Steel
FCQBLADE	Replacement Blade	Carbon Steel
FCQPROTRIM	"Pro" Trimmer	Tungsten Carbide
FCQPROBLADE	Replacement Blade	Tungsten Carbide

FCQPROTRIM

**NO SPRINGS!**



**Double-Sided Edgeling Trimmer**



- Simultaneously trims both edges of most soft edgebanding materials
- Duplicate blades on both sides will flush or bevel trim panels from 1/2" - 1-1/2" thick
- One side can be used alone as a single-sided trimmer

Item #	Description
PC-ET100	Trimmer
PC-ET100RP	Repl. Blades 6 per pack

A  
B  
C  
D  
E  
F  
G  
H  
I  
J  
K  
L  
M  
N  
O  
P  
Q  
R  
S  
T  
U  
V  
W  
X  
Y

**A UTILITY KNIVES & BLADES**

B  
C  
D  
E  
F  
G  
H  
I  
J  
K  
L  
M  
N  
O  
P  
Q  
R  
S  
T  
U  
V  
W  
X  
Y



**Utility Knife**

- Utility knife with multi-step locking
- Blade can be fully retracted
- Includes 1 standard utility blade; storage for 5 blades



<b>Item #</b>
WR07156601



**Utility Knife**

- 3 position retractable blade
- Includes 3 standard utility blades; storage for 5



<b>Item #</b>
STN10-099



**Utility Knife, INSTANTCHANGE®**

- Swing out blade storage and integrated string cutter
- Tool-free push-button blade change
- Includes 3 standard utility blades, storage for 10



<b>Item #</b>
STN10-788



**Utility Knife Replacement Blades**



Item #	Blade Thickness	Dispenser Included	Box Qty
STN11-921A	.024"	Yes	100
STN11-921B	.024"	No	400
WR1695106	.025"	No	100



**KNIVES & SCRAPERS**

A  
B  
C  
D  
E  
F  
G  
H  
I  
J  
K  
L  
M  
N  
O  
P  
Q  
R  
S  
T  
U  
V  
W  
X  
Y



**TriBlade Utility Knife**



- Heavy duty steel track with retractable blade and auto blade lock
- Comes with 3 blades and holds 2 extras
- Rubberized grip is comfortable to hold

Item #	Description
FCTB	TriBlade Knife with 3 blades
FCTBR	TriBlade replacement blades, pack of 10



**Razor Blade Scraper**



- Razor blade scraper is constructed of steel and has a fully retractable blade
- Comes with 5 blades

Item #
STN28-500



**Razor Blades, Single-Edge**



- Blades are individually wrapped for rust and edge protection
- 100 blades per box

Item #	Type	Blade Thickness	Brand
WR16033010	Standard Duty	.009"	Würth
STN11-515	Standard Duty	.009"	Stanley



**Pocket Pull Saw, Folding**



- Super flexible blade is only .015" thick
- Blade length: 3-5/8", overall length: 8-7/8", closed length: 5"
- Compact and safe to store in your pocket when closed
- Locked and ready to use when fully open

Item #
FCPKT-PULLSAW

**A SCRAPING & MARKING TOOLS**



**Hand Scraper**

- Extra flexible, spring steel blade
- Scraper is 4-3/4" wide



<b>Item #</b>
WR0695940912

A  
B  
C  
D  
E  
F  
G  
H  
I  
J  
K  
L  
M  
N  
O  
P  
Q  
R  
S  
T  
U  
V  
W  
X  
Y



**Putty Knife**

- Hardened, tempered and polished steel blade
- Permanently fastened full tang blades



	Item #	Blade Width	Blade Type	Handle Type
A	STN28-540	1-1/4"	Flexible	Wood
B	STN28-240	1-1/4"	Flexible	Nylon
	STN28-140	1-1/4"	Stiff	Nylon



**Long Nose Marker™**

- Solves the problem of marking inside holes or up against deep wall applications
- The ultimate permanent marker with both a super fine long tip and a wide tip on the reverse side



<b>Item #</b>
FCLONGNOSE



**FatBoy™ Retractable Pencil**

- Built-in eraser and removable clip, lightweight aluminum housing
- 5.5 mm lead
- Sharpens in standard pencil sharpener
- Great for framing and finish-work



Item #	Description
FCFATBOY-PENCIL	Pencil, 3 pieces of lead (1 each standard lead, red & soapstone and 1 eraser)
FCFATBOY-REFILL	5 Lead refills (standard lead), 3 erasers

**MARKING & MEASURING TOOLS**

A  
B  
C  
D  
E  
F  
G  
H  
I  
J  
K  
L  
M  
N  
O  
P  
Q  
R  
S  
T  
U  
V  
W  
X  
Y



**Reveal Square  
Door & Window Molding  
Installation Tool**



- Provides 8 different reveal dimensions for installation of door and window moldings
- Side one provides reveals of: 1/8", 1/4", 1/2", and 3/8";
- Side two provides reveals of 3/16", 5/16", 7/16", and 9/16"
- Slide the Reveal Square along the edge of the window or door frame at desired reveal and mark with a pencil line

<b>Item #</b>
FCREVEALSQ



**Scribing Tool**



- For installing countertops, cabinets, tile, and floor coverings

<b>Item #</b>
PC-AS4



**AccuScribe Pro™  
Scribing Tool & Compass**



- Ideal for scribing the trim on kitchen cabinets, architectural moldings, countertops, splashguards, tile, siding and even flooring
- Retractable compass point
- Articulating pencil head

<b>Item #</b>
FCACCUSCRIBPRO



**Pocket Awl, Folding**



- Compact and safe to store in your pocket when closed
- Locked and ready to use when fully open

<b>Item #</b>
FCPKT-AWL

**A TAPE MEASURES**



**ProCarpenter™ Tapes**



- All ProCarpenter tapes feature erasable note pad on tape casing side, built-in pencil sharpener and ergonomic belt clip, 8' standoff, dual thumb and finger locks
- All ProCarpenter tapes have a 1" wide tape (except FCPMS12 which is 5/8" wide)



Old Standby Standard		
Item #	Description	Length
FCPS16	Easy to read fraction call outs to 1/16"	16'
FCPS25	Easy to read fraction call outs to 1/16"	25'

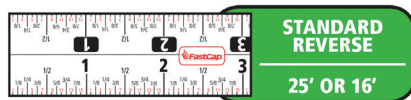

Standard/Standard Reverse		
Item #	Description	Length
FCPSSR16	Right & left reading	16'
FCPSSR16AL	Right & left reading, Auto-lock	16'
FCPSSR25	Right & left reading	25'



Standard Story Pole		
Item #	Description	Length
FCPSSP16	Features a blank edge on the blade for writing and standard measurements on the other edge	16'
FCPSSP25		



PMS Metric/Standard		
Item #	Description	Length
FCPMS12	Easy to read fraction call outs to 1/16" and millimeters	12'
FCPMS16		16'
FCPMS16-AUTO	Easy to read fraction call outs to 1/16" and millimeters, auto-lock	16'
FCPMS25	Easy to read fraction call outs to 1/16" and millimeters	25'



True 32 Metric Reverse		
Item #	Description	Length
FCPMMRTRUE32	For use with True 32 Flow manufacturing	5M



**Standard Peel & Stick 16' Tape**



- Puts a tape measure right where you need it
- The flat 16' long tape measure is printed on both sides allowing for left or right read
- Simply adhere the included SpeedTape to one side of the tape and stick it on

Item #	Description	Length
FCPSSSTICK16	Easy to read fraction call outs to 1/16"	16' (Can be cut to 8')



**TAPE MEASURES/SQUARES**



**Tape Measure, Auto Stop**

- Yellow nylon-coated steel tape with Metric and Inch markings
- Lightweight ABS plastic housing is lightweight and corrosion resistant
- End stop cushions tape when rolled in for longer tape life
- Auto stop when tape pulled out
- Sliding end hook
- Removable belt clip



Item #	Read	Blade Width	Blade Length
WR071464575	Metric/Inch	1"	16'

**PowerLock® Tape Measures**

- Mylar® polyester film extends life of entire blade
- Secure blade lock wont creep during measurements
- Tru-zero end hook for accurate measurements

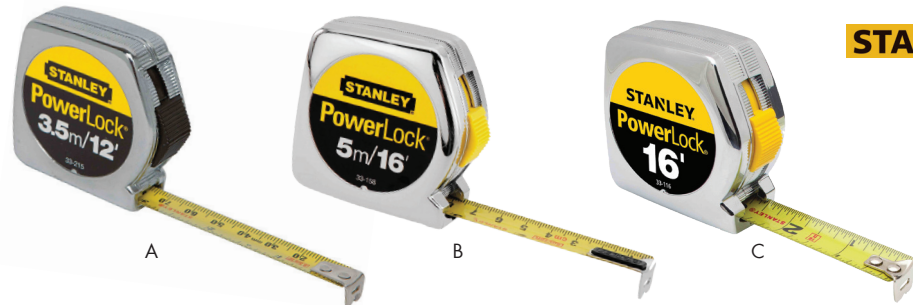

	Item #	Read	Blade Width	Blade Length	Stud Markings
A	STN33-215	Metric/Inch	1/2"	12' / 3.5m	16" and 19.2"
B	STN33-158	Metric/Inch	3/4"	16' / 5.0m	16"
C	STN33-116	Inch	3/4"	16'	16" and 19.2"



**SpeedClip™ Tape Measure Belt Clip**

- Clips over pants or belt for quick access to tape measure
- Securely holds a tape measure and a pencil
- Extension keeps tape measure from getting bumped off when bending down
- Built in pencil sharpener
- 2 bench mount holes



Item #
FCSPCLIP

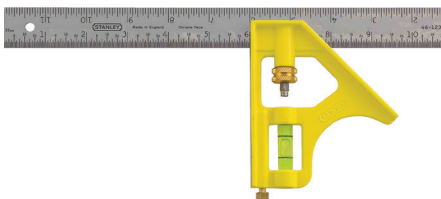

**Combination Square**

- Durably etched, hard-chrome-plated blades are rust resistant
- Built-in scriber comes in handy for surface marking
- High-visibility yellow, die-cast handle with brass hardware for durability
- Graduation in 1/8", 1/16" and 1/32"
- Ruler length is 12" and handle length is 4-1/2" long



Item #
STN46-123

A  
B  
C  
D  
E  
F  
G  
H  
I  
J  
K  
L  
M  
N  
O  
P  
Q  
R  
S  
T  
U  
V  
W  
X  
Y

**A KREG JIGS & ACCESSORIES**

B  
C  
D  
E  
F  
G  
H  
I  
J  
K  
L  
M  
N  
O  
P  
Q  
R  
S  
T  
U  
V  
W  
X  
Y



**Knuckle Bender™  
Interior Door Installation Tool**



- Used for installing full size residential doors
- Design allows you to get a hammer under the bottom hinge to easily tap out the pin without marring the hinge, door or trim

<b>Item #</b>
FCKNUCKLEBENDER



**Kreg Jig® R3**



- Number of Drill Guides: (2) 3/8" Dia. standard Kreg pocket holes
- For Use With: Materials from 1/2"- to 1-1/2" thick
- Drill Guide Spacings: 7/8"
- Clamping Method: Works with any Kreg Face Clamp
- Screw-Centering Ability: 1/2", 5/8", 3/4", 7/8", 1", 1-1/8", 1-1/4", 1-3/8", 1-1/2"
- Includes: Kreg Jig® R3, clamp pad adapter, stepped drill bit, 6" driver bit, depth collar, Allen wrench, starter Kreg screw set, starter Kreg pocket-hole plug set, and Owner's Manual, all inside of a durable, compact carrying case

Item #	Description
KRR3	Kreg Jig® Jr. (see included contents listed above)

For Kreg Screws, see Section P



**Kreg Jig® Mini**



- Number of Drill Guides: (1) 3/8" diameter standard Kreg pocket hole
- For Use With: Materials from 1/2"- to 1-1/2" thick
- Clamping Method: Works with Kreg Face Clamps and a variety of other clamps
- Screw-Centering Ability: 1/2" to unlimited
- Includes: Kreg Jig® Mini, Kreg drill bit, stop collar, Allen wrench, and Owner's Manual

Item #	Description
KRMKJKIT	Kreg Jig® Mini Kit (see contents listed above)

For Kreg Screws, see Section P

**KREG JIGS & ACCESSORIES**

A  
B  
C  
D  
E  
F  
G  
H  
I  
J  
K  
L  
M  
N  
O  
P  
Q  
R  
S  
T  
U  
V  
W  
X  
Y

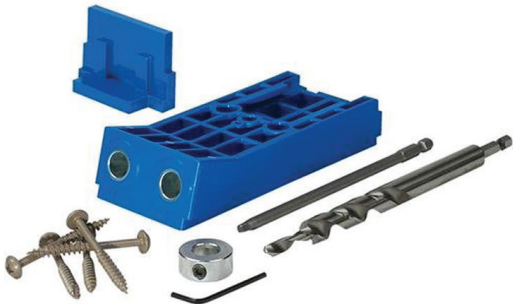

**Kreg Jig HD®**



- Number of Drill Guides: (2) 1/2" Dia. HD pocket holes
- For Use With: 1-1/2" thick material and up
- Drill Guide Spacings: 1-7/16"
- Clamping Method: Works with Kreg Face Clamps and a variety of other clamps
- Compatibility: Kreg Jig® K3, K4, K4MS, and K5 benchtop base
- Includes: HD Drill Guide, stop block, 1/2" diameter HD stepped drill bit, 6" HD driver bit, stop collar, Allen wrench, starter Kreg screw set, and Owner's Manual

For Kreg Screws, see Section P

Item #	Description
KRRRHD	Kreg Jig® HD
KRKJDHD	Replacement Drill Bit, HD



**Concealed Hinge Jig**



- Accurate hinge positioning with built-in indexing tabs
- Repeatable results with built-in measuring scales
- Reliable drilling with bit guide and stop collar
- Simple to use with any drill—no special tools needed
- Adjustable cams ensure proper hinge offset
- Durable carbide-tipped drill bit included

Item #	Description
KRKHI-HINGE	Concealed Hinge Jig
KRKHI-BIT	Replacement Bit



**Cabinet Hardware Jig**



- Install Knobs and Pulls the Worry-Free Way - with Easy, Repeatable Accuracy
- Adjustable guides for accurate hole placement
- Built-in measuring scales for repeatable results
- Versatile for mounting single and multi-hole knobs
- Adjustable edge guide for easy positioning
- Durable hardened-steel drill guides

Item #	Description
KRKHI-PULL	Cabinet Hardware Jig

**A KREG JIGS & ACCESSORIES**

B  
C  
D  
E  
F  
G  
H  
I  
J  
K  
L  
M  
N  
O  
P  
Q  
R  
S  
T  
U  
V  
W  
X  
Y



**Shelf Pin Jig**



- Dual Position Adjustable Fence requires no tools
- Locating Pin lets you quickly reference the last hole drilled
- Jig Extender allows you to connect multiple jigs together for high speed work
- Standard 32mm hole spacing
- 5mm or 1/4" brad point drill bit included
- Drill bit storage built in to back of jig

Includes: Shelf-Pin Jig, Locating Pin, Jig Extender, 5mm or 1/4" Drill Bit, Depth Collar, Allen Wrench, Four 5mm or 1/4" Shelf Pins, Instructions

Item #	Description
KRKMA3200	Shelf Pin Jig, 1/4"
KRKMA3215	Shelf Pin Jig, 5mm
KRKMA3210	1/4" Brad Point Drill Bit
KRKMA3220	5mm Brad Point Drill Bit



**Drawer Slide Jig**



- Install Drawer Slides the fast, easy way for drawers that fit perfectly every time and slide smoothly
- Accurate slide positioning with built-in indexing tabs
- Repeatable results without measuring and marking
- Versatile for use in cabinets, cases, and more
- Reversible to mount slides to cabinet and drawer box

NOTE: Clamps in picture are not included

Item #	Description
KRKHI-SLIDE	Drawer Slide Jig



**Crown-Pro™**



- Holds trim at the exact angle required, eliminating need for advanced compound miter cuts
- Curved design lets you compensate for a variety of crown molding spring angles (30 to 60 degrees)
- Extension arms let you work with crown up to 5-1/2" wide
- Included angle-finder helps you determine the correct spring angle and wall angle for accurate results; range of 30° - 65°
- 10" saws work with crown up to 3-1/2" wide; 12" saws work with crown up to 5-1/2" wide (both depend on manufacturer)

Includes: Crown-Pro™, Double-Sided Angle Finder, and Rubber Feet

Item #	Description
KRKMA2800	Crown Molding Jig



## HARDWARE & SHELF PIN JIGS



### Cabinet Hardware Jig

- Install hardware 10x faster
- Minimum c/c: 1-1/8" (28mm)
- Maximum c/c: 12" (305mm)
- Saves wasted time making wood templates
- Durable aircraft quality aluminum
- 3/16" case hardened steel bushings are replaceable
- Includes: Blow Molded Case and standard 3/16" drill bit



Bushings are backed with a lifetime warranty.

Includes Blow Molded Case

Item #

TP-1934



### Cabinet Hardware Jig Plus Shelf Pin/Long Handle Jig

- Install hardware 10x faster
- Minimum c/c: 1-1/8" (28mm)
- Maximum c/c: 30-1/4" (768mm)
- Durable aircraft quality aluminum
- 3/16" case hardened steel bushings are replaceable
- Includes: TP-ERA Extended Ruler Attachment and Blow Molded Case



Bushings are backed with a lifetime warranty.

Includes Blow Molded Case

Item #

TP-1935

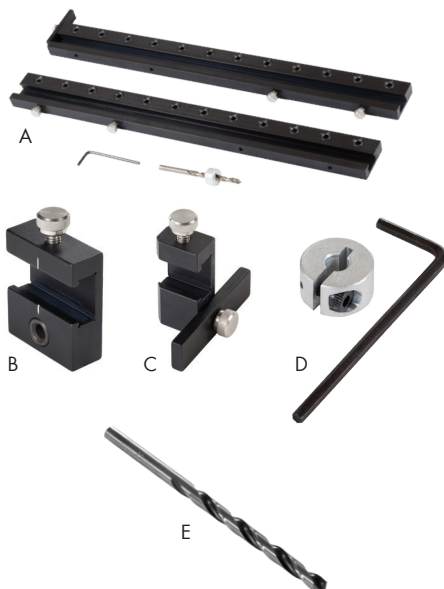

### Cabinet Hardware & Shelf Pin Jig Accessories



Item #	Description
A	TP-2312 Add on extension bars for JKTP-1934. Convert the hardware jig into a portable line boring unit. Also capable of installing cabinet handles up to 30-1/4" (768mm).
B	TP-SDG Sliding Drill Guide for all True Position models. Used for quick shelf hole layouts.
C	TP-SES Replacement sliding end stop assembly for all True Position models.
D	TP-5MMSC Split Ring Stop Collar for 5mm drill bits, adjustable design is made of aluminum.
E	TP-5MMJ 5mm Ultra Bor Super Premium Drill Bit, Black & Gold 5mm Jobber Length. Hi-Molybdenum tool steel with 135 degree split points for fast penetration and accurate starting without a center punch. Ideal for solid woods.
	TP-5MMB 5mm Brad Point HSS bit, HSS is ideal for woods and plastics. Brad point for clean holes in melamines, veneers and other woods.

A  
B  
C  
D  
E  
F  
G  
H  
I  
J  
K  
L  
M  
N  
O  
P  
Q  
R  
S  
T  
U  
V  
W  
X  
Y

**A 3RD HAND SUPPORTS**

**3rd Hand Extending Supports, 150 lb Capacity**



- Adjustable support systems for a variety of jobs
- Useful in the shop and on the jobsite



**A** Designed to support upper cabinets after the base cabinets are in place



**B** Designed to support upper cabinets when the base cabinets are not yet in place



**C** Brace, jack, or support whatever you need!

	Item #	Size	Features	Includes
A	FC3HL	16.5" - 23.5"	• Micro-adjustment	(1) jack and (2) 6x6 support feet
	FC3HL-2PC		• Micro-adjustment	(2) jacks and (4) 6x6 support feet and carrying bag
B	FC3H-UPPER	28" - 60"	• Precision pump jack	(1) jack, (2) 6x6 support feet
	FC3HUPPERHANDKIT		• Ball detent for positive lock	(2) jacks and (4) 6x6 support feet and carrying bag
C	FC3H5HD	57" - 144"	• Precision pump jack	(1) jack, (2) 3x3 articulating feet,
	FC3H5HD-2PK		• Ball detent for positive lock	(1) magnetic dust barrier foot
			• Micro-adjustment"	(2) jacks, (2) 3x3 articulating feet,
				(2) magnetic dust barrier feet

**HAMMERS/NAIL SETS**

A  
B  
C  
D  
E  
F  
G  
H  
I  
J  
K  
L  
M  
N  
O  
P  
Q  
R  
S  
T  
U  
V  
W  
X  
Y



**Rubber Mallet**

**STANLEY.**

- Tough rubber head molded to a lacquered wooden handle
- Rubber head helps minimize marring and surface damage

Item #	Length	Weight
STN57-522	13-1/4"	18 oz.



**Dead Blow Hammer**

**STANLEY.**

- Uni-Cast™ construction of nonferrous materials eliminate sparking and won't absorb liquids
- Dead-blow function uses steel shot to eliminate bounce back

Item #	Length	Weight
STN57-531	11-1/4"	18 oz.



**Curve Claw Hammer**

**STANLEY.**

- Forged high-carbon steel head, fully heat-treated and polished bell face
- Hickory handle

Item #	Length	Weight
STN51-616	13-1/4"	16 oz.



**3 Piece Steel Nail Set**

**STANLEY.**

- Three piece set has three different tip sizes: 1/32", 2/32" and 3/32"
- Square head to prevent rolling when set down
- Round knurled body
- Alloy steel is hardened and tempered

Item #
STN58-230



**A WÜRTH HAND TOOLS - TABLE OF CONTENTS**

**B**  
**C**  
**D**  
**E**  
**F**  
**G**  
**H**  
**I**  
**J**  
**K**  
**L**  
**M**  
**N**  
**O**  
**P**  
**Q**  
**R**  
**S**  
**T**  
**U**  
**V**  
**W**  
**X**  
**Y**

**Würth Hand Tools Contents:**

Warranty Information.....	27
Wrenches.....	28-37
Allen Keys.....	38-39
Screwdrivers.....	40-49
Screwdrivers, T-Handle.....	50-53
Bits & Accessories.....	54-57
Ratchets.....	58-59
Sockets.....	60-73
Ratchet & Socket Assortments.....	74-75
Pliers & Cutters.....	76-84
Snips.....	85-86



## WÜRTH LOUIS AND COMPANY – LIMITED WARRANTY POLICY

### Würth Louis and Company – Limited Warranty Policy

This limited warranty policy ("Limited Warranty Policy") represents Würth Louis and Company's ("the Company") commitment to our customers and our effort in ensuring the quality of our products.

If you are the original purchaser of our product, the Company warrants, for the time period indicated below (the "Warranty Coverage"), each Würth Louis and Company product to be free from defects in materials and workmanship under normal use and service, when installed, adjusted, used, and maintained, in the manner they were intended.

WÜRTH PRODUCT	WARRANTY COVERAGE
<ul style="list-style-type: none"> <li>"Zebra" brand hand tools</li> </ul>	<p><b>Limited lifetime warranty</b></p> <p>Würth Louis and Company warrants these products for its useful life against deficiencies in material and workmanship</p>
<ul style="list-style-type: none"> <li>Würth brand hand tools</li> </ul>	<p><b>1-year Limited Warranty</b></p> <p>Würth Louis and Company warrants these products for one (1) year from the date of purchase of the original purchaser</p>
<p>Please note that the Limited Lifetime Warranty and the 1-year Limited Warranty are subject to the provisions and limitations contained in this Limited Warranty Policy and in any applicable Würth Louis and Company terms and conditions of sale.</p>	

Repair, replacement (same or similar product), or credit at the original sale price at Würth Louis and Company's option will be furnished if the product, upon Würth's standard investigation process, is found to be properly installed, adjusted, used, maintained, stored, and/or operated.

Any such repairs or replacement will be made at no charge to the customer for parts or labor, provided that the customer shall be responsible for any transportation, lodging, meals, and/or other personal costs.

This Limited Warranty Policy does not apply to any malfunctions caused by: (i) normal wear and tear, (ii) unreasonable and/or improper use, misuse, neglect, abuse, improper storage, improper exposure to elements, and/or insufficient maintenance, (iii) repair or service by unauthorized persons, and (iv) modifications and/or alterations made without the express written permission of Würth Louis and Company.

Würth Louis and Company consumable products are free from manufacturer's defect upon delivery but do not carry any further warranty unless specifically expressed on the product itself.

This limited warranty is non-transferrable and can only be availed by the original purchaser of the product. A proof of purchase is required for all warranty claims. To obtain warranty service, contact your sales representative for warranty assistance or call 1-800-422-4389 for your nearest authorized Würth Louis and Company sales representative.

EXCEPT FOR THE LIMITED WARRANTY PROVIDED HEREIN, TO THE EXTENT PERMITTED BY LAW, WÜRTH DISCLAIMS ALL OTHER WARRANTIES, EXPRESS OR IMPLIED, INCLUDING ALL WARRANTIES OF MERCHANTABILITY AND/OR FITNESS FOR A PARTICULAR PURPOSE. TO THE EXTENT THAT ANY IMPLIED WARRANTIES MAY NONETHELESS EXIST BY OPERATION OF LAW, ANY SUCH WARRANTIES ARE EXPRESSLY LIMITED TO THE WARRANTY COVERAGE PERIOD ASSOCIATED WITH EACH PRODUCT STATED HEREIN.

The terms in this Limited Warranty Policy represent Würth Louis and Company's exclusive written warranty. Würth Louis and Company makes no other express warranty, nor is anyone authorized to make any warranties on its behalf.

REPAIR OR REPLACEMENT OF WÜRTH LOUIS PRODUCTS, AS PROVIDED HEREIN, IS YOUR EXCLUSIVE REMEDY. WÜRTH LOUIS AND COMPANY SHALL NOT BE LIABLE FOR ANY SPECIAL, INCIDENTAL, ECONOMIC OR CONSEQUENTIAL DAMAGES, INCLUDING, BUT NOT LIMITED TO, LOST REVENUES, LOST PROFITS, STRICT LIABILITY IN TORT AND/OR IN NEGLIGENCE, AND THIRD PARTY CLAIMS, INCIDENTAL OR CONSEQUENTIAL, LABOR COSTS, INSTALLATION CHARGES, TELEPHONE CHARGES, OR TRANSPORTATION CHARGES IN CONNECTION WITH THE REPLACEMENT AND/OR REPAIR OF DEFECTIVE PARTS OR PRODUCTS.

Customer understands that Würth Louis and Company is a distributor only and as such, Würth Louis and Company assumes no liability whatsoever with regard to the original purchaser's compliance or fulfillment of its obligations with respect to any statute, regulation, or by-law.

Please note that while Würth Louis and Company has made diligent efforts to illustrate and describe the products shown in its catalogues and online media, these illustrations and descriptions however, are for the sole purpose of identification and do not express nor imply a warranty or condition that the products shown are merchantable, fit for a particular purpose, nor does it guarantee that the products will necessarily conform to the illustrations and descriptions.

Würth Louis and Company reserves the right to make changes in design, appearance, and construction of any and all Würth Louis and Company products and reserves the right to discontinue the availability of any products and/or service to any discontinued products, at any time, at its sole discretion. Würth Louis and Company assumes no responsibility whatsoever in making such changes in products previously sold and/or transferred. Further, Würth Louis and Company assumes no obligation in replacing any previously sold, discontinued, and/or transferred product with an updated and/or similar product.

A  
B  
C  
D  
E  
F  
G  
H  
I  
J  
K  
L  
M  
N  
O  
P  
Q  
R  
S  
T  
U  
V  
W  
X  
Y



**A WRENCHES**

**Limited Warranty Policy - Hand Tools**

This limited warranty policy commitment to our customers (original purchaser) and our effort in ensuring the quality of our products. Please contact your Sales Rep or Customer Service Representative for full warranty details.

Würth Hand Tool Product	Warranty Coverage
Zebra brand hand tools	<b>Limited Lifetime Warranty:</b> Würth Louis and Company warrants these products for its useful life against deficiencies in material and workmanship when used in the manner intended
Würth brand hand tools	<b>1-year Limited Warranty:</b> Würth Louis and Company warrants these products for one (1) year from the date of purchase of the original purchaser when used in the manner intended.

**ZEBRA POWERDRIV® Combination Wrench - Extra Slim**

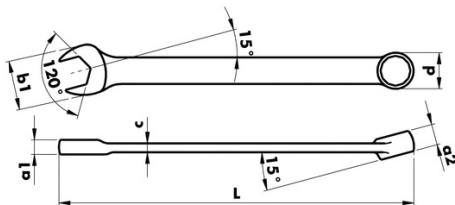

- Drive: Box end **POWERDRIV®** 12 point
  - Standard: DIN 3113A / ISO 3318/7738
  - Geometry: Box end 15° angled, open-end position 15°
  - Material: Chrome vanadium steel
  - Surface: Chrome-plated, matte satin finish
- Packing & Sold in: Each

Item #	(mm)	L (mm)	a1 (mm)	a2 (mm)	b (mm)	c (mm)	Dia. d (mm)
WR071330908	8	139	4.2	6.5	14.7	2.6	12
WR071330916	16	206	7	12.1	29.2	4.3	22.3
WR071330918	18	233	8	13.1	32.2	4.7	25.3
WR071330919	19	244		13.5	33.7	5	26.8

**ZEBRA Double Open-End Wrench Assortment**

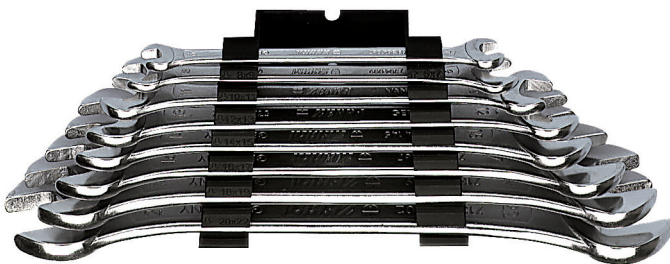

- Metric**
- 12 pieces, with plastic holder**
- Standard: DIN 3110 / ISO 1085
  - Material: Chrome-vanadium steel
  - Surface finish: Chrome-plated polished heads
  - Open-end position 15°, strong heads for heavy duty use
- Packing & Sold in: Each

Item #	Set	in mm
WR071330443	12 pieces	6x7, 8x9, 10x11, 12x13, 14x15, 16x17, 18x19, 20x22, 21x23, 24x27, 25x28, 30x32

**WRENCHES**

**POWERDRIV® (12-Point) Double Box End Wrench - Extra Long**

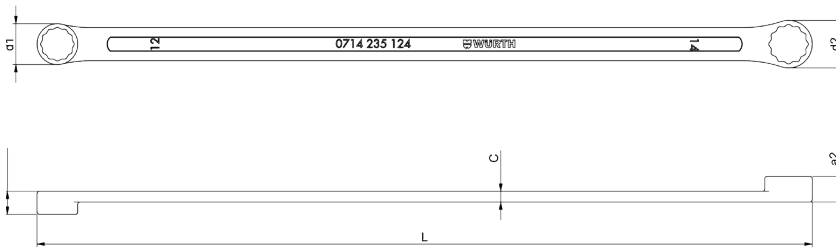

**Universal joint shaft flange, axle, ball and suspension joints, axle linkages**

**For high tightening and release forces**

- Metric
  - Drive: Double box end **POWERDRIV®** 12-point
  - Standard: Wrench size according to DIN 475 Part II
  - Material: Chrome-vanadium steel
  - Surface: Body chromed, matte satin
  - Geometry: Straight, very slim box-end design for hard to reach places
- Packing & Sold in: Each

Item #	WR0714235101	WR0714235124	WR0714235135	WR0714235168	WR0714235179
Size	10 x 11 mm	12 x 14 mm	13 x 15 mm	16 x 18 mm	17 x 19 mm
Outside diameter d1	15 mm	17.2 mm	20 mm	22.6 mm	26 mm
Outside diameter d2	18.1 mm	20 mm	21.6 mm	26 mm	26.5 mm
Thickness a1	8 mm	9.7 mm	11 mm	12.3 mm	13.8 mm
Thickness a2	9 mm	10.8 mm	12 mm	13.3 mm	14 mm
Shank thickness c	4mm	4.5 mm	5 mm	5 mm	5.4 mm
Length l	292 mm	327 mm	367 mm	388 mm	410 mm

**ZEBRA POWERDRIV® (12-Point) Combination Wrench Set - Short Type (8 Pieces - 3/8, 7/16, 1/2, 9/16, 5/8, 11/16, 3/4, 7/8 Inch)**



**Standard**

**8 piece set**

- Standard: DIN 3113A/ISO 3318/773
  - Drive: Box end **POWERDRIV®** (12-Point)
  - Material: Chrome-vanadium steel
  - Surface: Chrome-plated, polished
  - Geometry: Box end angled 15°, open end offset 15°
- Packing & Sold in: Each

Item #	Inch	
WR071330340	3/8, 7/16, 1/2, 9/16, 5/8, 11/16, 3/4, 7/8	

A  
B  
C  
D  
E  
F  
G  
H  
I  
J  
K  
L  
M  
N  
O  
P  
Q  
R  
S  
T  
U  
V  
W  
X  
Y

A  
B  
C  
D  
E  
F  
G  
H  
I  
J  
K  
L  
M  
N  
O  
P  
Q  
R  
S  
T  
U  
V  
W  
X  
Y

**WRENCHES**

**ZEBRA POWERDRIV® Combination Wrench - Short Type**



**Metric**

- Standard: DIN 3113A/ISO 3318/7738
  - Drive: Box end **POWERDRIV®** (12-Point)
  - Material: Chrome-vanadium steel
  - Surface: Chrome-plated, polished heads and ring
  - Geometry: Box end angled 15°, head angle 15°
- Packing & Sold in: Each

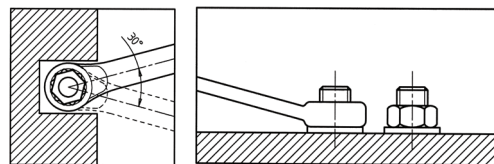
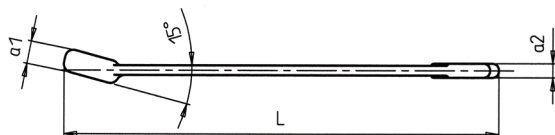

Item #	(mm)		L (mm)	b1 (mm)	Dia. d (mm)	a1 (mm)	a2 (mm)
WR0713301055	5.5		100	14.0	10.5	5.5	3.7
WR071330106	6						
WR071330107	7		110	16.0	11.8	6.0	4.0
WR071330108	8						
WR071330109	9		130	20.0	14.6	7.0	4.5
WR071330110	10						
WR071330111	11		150	25.0	17.4	8.0	5.0
WR071330112	12						
WR071330113	13		170	29.0	20.4	9.0	5.5
WR071330114	14						
WR071330115	15		190	33.5	22.9	10.0	6.0
WR071330116	16						
WR071330117	17		205	38.0	26.1	10.5	6.5
WR071330118	18						
WR071330119	19		230	42.0	29.9	11.5	7.5
WR071330120	20						
WR071330121	21		250	47.0	32.2	12.5	8.0
WR071330122	22						
WR071330123	23		270	51.0	35.2	14.0	9.0
WR071330124	24						
WR071330125	25		290	55.0	38.5	15.0	9.0
WR071330126	26						
WR071330127	27		310	59.0	40.8	15.5	10.0
WR071330128	28						
WR071330129	29		330	63.5	43.8	16.5	11.0
WR071330130	30						
WR071330132	32		350	69.0	47.8	17.5	12.0
WR071330134	34						

**WRENCHES**

**Zebra Powerdriv® Combination Wrench - Short Type**

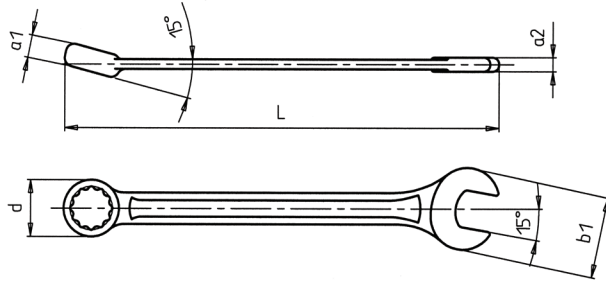

**Standard**

- Standard: DIN 3113A/ISO 3318/773
  - Drive: Box end **POWERDRIV®**, 12-point
  - Material: Chrome-vanadium steel
  - Surface: Chrome-plated, polished
  - Geometry: Box end angled 15°, open-end offset 15°
- Packing & Sold in: Each



Item #	(in.)	L (mm)	b1 (mm)	Ø d (mm)	a1 (mm)	a2 (mm)
WR071330303	3/8"	140	22.5	16.1	7.5	4.5
WR071330304	7/16"	150	25	17.4	8	5
WR071330305	1/2"	170	29	20.4	9	5.5
WR071330306	9/16"	180	31	21.6	9.5	6
WR071330307	5/8"	200	36	24.6	10	6
WR071330308	11/16"	205	38	26.1	10.5	6.5
WR071330309	3/4"	230	42	29.9	11.5	7.5
WR071330311	7/8"	260	49	33.7	13.5	8

**Zebra Powerdriv® Combination Wrench Assortment - Short Type**

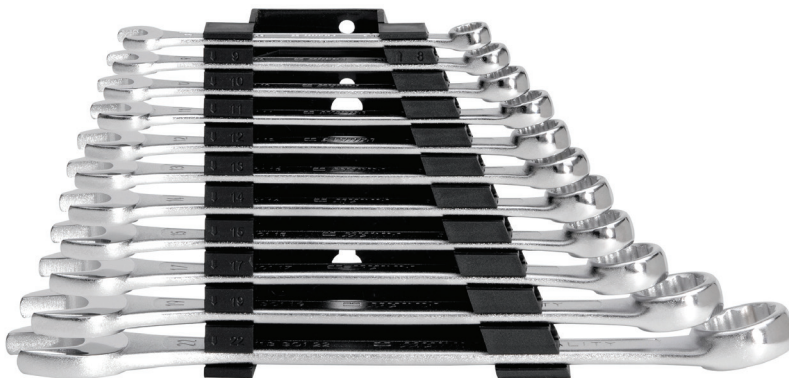

**Metric**

**11 pieces, with plastic holder**

- Box end **POWERDRIV®** (12 point)
  - Standard: DIN 3113A/ISO 3318/7738
  - Material: Chrome-vanadium steel
  - Surface Finish: Chrome-plated polished heads
  - Open-end position 15°, strong heads for heavy duty use
  - 12-Point box-end and open-end position of 15° for an optimal grip ratio, resulting in minimal rotating angle
  - The 15° angle of the box end provides more free space for the fingers or to work around obstacles
- Packing & Sold in: Each



Item #	Set	(mm)
WR071330140	11 pieces	8, 9, 10, 11, 12, 13, 14, 15, 17, 19, 22

A  
B  
C  
D  
E  
F  
G  
H  
I  
J  
K  
L  
M  
N  
O  
P  
Q  
R  
S  
T  
U  
V  
W  
X  
Y

**A WRENCHES**

**Zebra Powerdriv® (12-Point) Dual Ratchet Combination Wrench**



**Innovative wrench with ratchet function on the box and open sides.**

- Drive: Box end POWERDRIV® modified 12 point, open side with open ratchet segment
  - Standard: Max. torque as per DIN 899
  - Material: Chrome-vanadium steel
  - Surface: polished, chrome-plated
  - Geometry: Straight on box end, 15° angle on open end
  - To change the turning direction, simply turn the wrench around
  - Open side features moving ratchet segment
  - Enables working without stopping, as the wrench no longer needs to be taken off the nut. Ideal for all line screw joints
  - Fine-toothed on ring side, 72 teeth, 5° rotating angle
  - Very rugged and strong ratchet for high tightening torques
- Packing & Sold in: Each

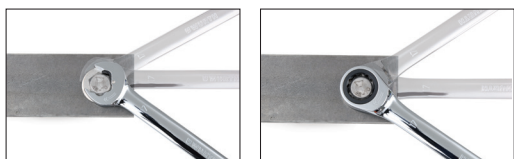

**Areas of use:**

- Designed for union screw joints, e.g. brake lines, injection lines, air conditioning, hydraulics etc.

Item #	Sizes (mm)					
		L (mm)	a1 (mm)	a2 (mm)	Dia. d (mm)	b1 (mm)
WR071425908	8	140	4.1	6.5	16.8	16.7
WR071425909	9	149	4.3	6.9	18.8	18.7
WR071425910	10	158	4.8	7.3	20.8	20.8
WR071425911	11	165	5.1	7.7	21.8	23.5
WR071425912	12	171	5.3	8.2	22.8	24.6
WR071425913	13	178	5.9	8.6	24.8	26.8
WR071425914	14	190	6.3	9.0	27.8	29.0
WR071425915	15	199	6.6	9.4	28.8	31.0
WR071425916	16	208	6.9	9.9	30.8	33.0
WR071425917	17	225	7.3	10.3	31.8	35.5
WR071425918	18	236	7.8	10.7	32.8	37.5
WR071425919	19	247	8.3	11.2	33.8	39.4
WR071425921	21	289	8.8	13.0	40.0	45.8
WR071425922	22					
WR071425924	24	322	9.8	14.5	46.0	51.8

**Zebra Powerdriv® (12-Point) Dual Ratchet Combination Wrench Assortment**



**Innovative wrench with ratchet function on the box and open ends**

- 6 pieces, with plastic holder
- 1 ratchet combination wrench with double-ended ratchet function in each of the following sizes: 8; 10; 12; 13; 17; 19

Packing & Sold in: Each

Item #	Set	Sizes (mm)
WR071425950	6 pieces	8, 10, 12, 13, 17, 19 mm including plastic holder



# WRENCHES

## Zebra Powerdriv® Ratchet Combination Wrench - Flexible Joint

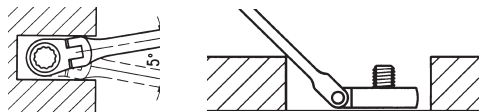

The 180° flexible joint of the box end of the wrench allows for easy access to tight areas.

- Flexible joint ratchet head provides greater freedom for fingers and overcomes obstacles
  - Very rugged, strong ratchets for high tightening torques
  - Design: Metric
  - Drive: Box end POWERDRIV® 12-point, fine-tooth 72 teeth
  - Standard: Max. torque in line with DIN 899
  - Material: Chromium-vanadium steel
  - Surface: Chrome-plated, matte satin finish
  - Geometry: Open-end offset 15°, box end 180° joint, strong heads for heavy-duty applications
- Packing & Sold in: Each

**Attention:** This is a special tool that may not be subjected to loads in excess of maximum torque values. For that reason, the tool is of limited suitability for loosening of tight screws.

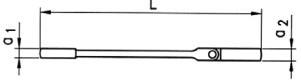
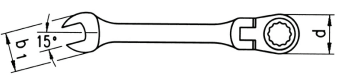
Item #	 Sizes (mm)						
		L (mm)	a1 (mm)	a2 (mm)	d (mm)	b1 (mm)	F max. Nm
WR071426308	8	140	4.3	6.5	16.1	16.7	35
WR071426309	9	150	4.6	6.9	17.9	18.8	46
WR071426310	10	159	5.0	7.3	19.6	20.9	59
WR071426311	11	165	5.4	7.7	21.4	23.0	74
WR071426312	12	172	5.8	8.2	22.7	25.1	91
WR071426313	13	178	6.1	8.6	24.7	27.2	109
WR071426314	14	191	6.4	9.0	26.4	29.3	131
WR071426315	15	200	6.9	9.4	27.7	31.3	153
WR071426316	16	208	7.2	9.9	29.4	33.4	179
WR071426317	17	226	7.6	10.3	31.2	35.5	205
WR071426318	18	237	8.0	10.7	32.4	37.6	235
WR071426319	19	248	8.6	11.2	33.4	39.7	266
WR071426321	21	274	9.0	13.0	39.7	46.0	330
WR071426322	22						368
WR071426324	24	296	10.0	14.5	45.9	52.3	451

## Zebra Powerdriv® Ratchet Combination Wrench Assortment - Flexible Joint



Flexible Joint

6 pieces, with plastic holder

- 1 ratchet combination wrench in each of the following sizes: 8; 10; 12; 13; 17; 19

Packing & Sold in: Each

Item #	Set	Sizes (mm)
WR071426350	6 pieces	8, 10, 12, 13, 17, 19

**A WRENCHES**

**Zebra Hexagon Powerdriv® Double Open End Line Wrench**



- Metric
  - Drive: Hexagon **POWERDRIV®**
  - Standard: DIN 3118
  - Geometry, open end profile angled 15°, open end angled 5°
  - Material: Chrome-vanadium steel
  - Surface: Chrome-plated, polished heads
- Packing & Sold in: Each

Item #	(mm)							
		L (mm)	a1 (mm)	a2 (mm)	Dia. d1 (mm)	Dia. d2 (mm)	B1 min. (mm)	B2 min. (mm)
WR0714240079	7 x 9	140	6.5	7.5	17.8	19.3	5	7
WR0714240080	8 x 10						6	
WR0714240113	11 x 13	174	8.5	10.5	22.8	25.3	9	11
WR0714240124	12 x 14							
WR0714240179	17 x 19	212	12	13	31.2	33.3	14	15

**Zebra Hexagon Powerdriv® Double Open End Line Wrench Assortment**



- Metric**
- 5 pieces, with plastic holder**
- Drive: Hexagon **POWERDRIV®**
- Standard: DIN 3118
- 1 each of double open end ring wrench size:  
7 x 9, 8 x 10, 11 x 13, 12 x 14, 17 x 19
- Packing & Sold in: Each

Item #	Set	(mm)
WR071424050	5 pieces	7 x 9, 8 x 10, 11 x 13, 12 x 14, 17 x 19

**WRENCHES**

**Zebra Powerdriv® (12-Point) Double Box End Wrench - Deep Offset**

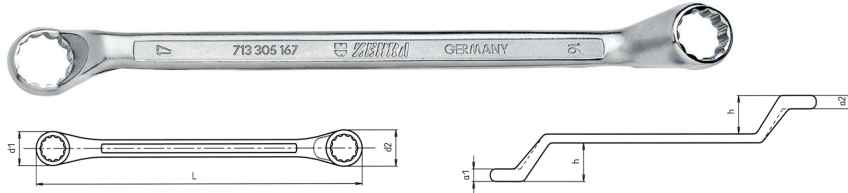

- Metric, DIN 838/ISO 3318
  - Drive: **POWERDRIV®**, 12 point
  - Material: Chrome-vanadium steel
  - Surface: Chrome-plated, polished
  - Geometry: Box ends offset 18°
- Packing & Sold in: Each

Item #	(mm)	L (mm)	a1 (mm)	a2 (mm)	dia. d1 (mm)	dia. d2 (mm)	h (mm)
WR0713305067	6x7	174	5.4	5.9	10.8	12.2	21
WR0713305089	8x9	187	6.4	6.9	13.2	14.7	23
WR0713305080	8x10	188	6.9	7.9		16.3	
WR0713305101	10x11	194	7.4	7.9	16.3	17.4	23.5
WR0713305103	10x13	215	7.9	9.9	16.3	20.7	24.5
WR0713305123	12x13	217	8.4	9.5	19.0	20.7	25
WR0713305137	13x17	243	9.9	11.8	20.7	26.2	27.5
WR0713305145	14x15	227		10.3	22.1	23.4	
WR0713305167	16x17	247	10.8	11.3	25.4	26.2	28
WR0713305168	16x18	250	11.3	11.8	25.6	28.2	
WR0713305179	17x19	284			28.0	29.4	29.5
WR0713305189	18x19		30				
WR0713305202	20x22	296	11.8	12.8	31.2	33.1	31
WR0713305213	21x23	312	12.3		32.1	35.5	
WR0713305224	22x24	313	12.8	14.3	33.0	37.0	34
WR0713305246	24x26	328		13.8	37.0	39.0	
WR0713305247	24x27	329		14.3	41.0		
WR0713305258	25x28	339	13.8	14.8	37.8	42.0	37
WR0713305279	27x29	342	14.8	15.8	41.0	44.3	36.3
WR0713305302	30x32	359			45.0	48.2	
WR0713305304	30x34	397			15.8	16.7	45.3

**Zebra Powerdriv® (12-Point) Double Box End Wrench Sets - Deep Offset**



- Drive: **POWERDRIV®** (12-point)
  - Material: Chrome-vanadium steel
  - Surface: Chrome-plated, polished
  - Geometry: Box end offset 18°
- Packing & Sold in: Each



**Item # WR071330540**

Metric, DIN 838/ISO 3318, 8 pieces  
 Sizes (in mm) 6x7, 8x9, 10x11, 12x13, 14x15, 16x17, 18x19, 20x22

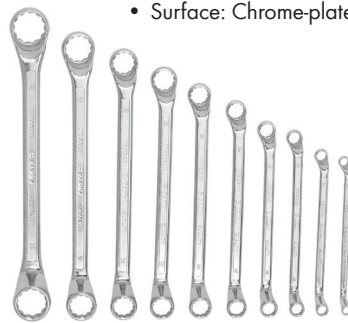

**Item # WR071330541**

Metric, DIN 838/ISO 3318, 10 pieces  
 Sizes (in mm) 8x9, 10x11, 12x13, 14x15, 16x17, 18x19, 20x22, 21x23, 24x27, 30x32



**Item # WR071330542**

Metric, DIN 838/ISO 3318, 12 pieces  
 Sizes (in mm) 6x7, 8x9, 10x11, 12x13, 14x15, 16x17, 18x19, 20x22, 21x23, 24x27, 25x28, 30x32

A  
B  
C  
D  
E  
F  
G  
H  
I  
J  
K  
L  
M  
N  
O  
P  
Q  
R  
S  
T  
U  
V  
W  
X  
Y

**A WRENCHES**

**Zebra Powerdriv® (12-Point) Double Box End Ratchet Wrench - 4-In-1**



- Metric, straight
- Output: Double box end **POWERDRIV®** (12-point)
- Finely toothed, 72 teeth
- Single-handed operation via reversing lever for clockwise and counterclockwise rotation
- Material: Chrome-vanadium steel
- Basic body surface: chrome-plated, high-gloss polished
- Geometry: Straight box end
- 4 sizes in one ratchet wrench
- Most common wrench sizes are covered by only 2 ratchet wrench
- 1/4" bit adapter available
- Simply insert into size 10 mm ratchet wrench to use as a bit ratchet
- For hard-to-access areas
- Narrow ratchet head

Packing & Sold in: Each

Item #	(mm)							d1 (mm)	d2 (mm)
		L (mm)	a1 (mm)	a2 (mm)	b1 (mm)	b2 (mm)			
WR0714257013	8x10 + 12x13	150	7.3	8.6	13.8	16.8	20.2	24.8	
WR0714257017	10x19 + 13x17	200	9.0	11.2	17.1	21.9	27.2	33.6	
WR0714257019	16x17 + 18x19	230	10.3		20.2		31.5	33.5	

**Zebra Powerdriv® (12-Point) Double Box End Ratchet Wrench Set 4-In-1 (3 Pieces)**



**Innovative double-sided, double-ended ratcheting wrench**

- Drive: Double-box end **POWERDRIV®** 12-point, fine-toothed, 72 teeth, one-hand operation via reversing lever for clockwise and counterclockwise use
- Material: Chrome-vanadium steel
- Surface: Chrome-plated, high gloss polish
- Geometry: box end straight
- Four sizes per ratchet wrench; the most common sizes are covered by only two ratchet wrenches
- 1/4" bit adapter available: simply insert in size 10 mm ratchet wrench, can then be used as a bit ratchet
- Narrow ratchet head for hard-to-reach areas-



5° angle of rotation for working in the tightest of spaces. Precision-machined ring core for smooth and secure use.

Item #	Set (comes in a clear plastic blister pack)	(mm)	Finish
WR071425730	3 pieces	8 x 10 + 12 x 13, 16 x 17 + 18 x 19 Bit adapter: 10 mm 1/4", 20 mm long	Chrome
WR0714257300	3 pieces	8 x 10 + 12 x 13, 16 x 17 + 18 x 19 Bit adapter: 10 mm 1/4", 20 mm long	Black Chromium



**WRENCHES**

A  
B  
C  
D  
E  
F  
G  
H  
I  
J  
K  
L  
M  
N  
O  
P  
Q  
R  
S  
T  
U  
V  
W  
X  
Y

**Zebra Double Open-Ended Wrench Assortment - Metric**



Item # **WR0965900404**

**8 Pieces**

**Contents:**

**Size (in mm)**

- 6 x 7, 8 x 9, 10 x 11, 12 x 13, 14 x 15, 16 x 17, 18 x 19, 20 x 22
- Includes foam insert



**Zebra Combination Wrench Assortment - Metric**



Item # **WR0965900403**

**11 Pieces**

**Contents:**

**Size (in mm)**

- 8, 9, 10, 11, 12, 13, 14, 15, 17, 19, 22
- Includes foam insert



**Zebra Combination Wrench Assortment - Metric**

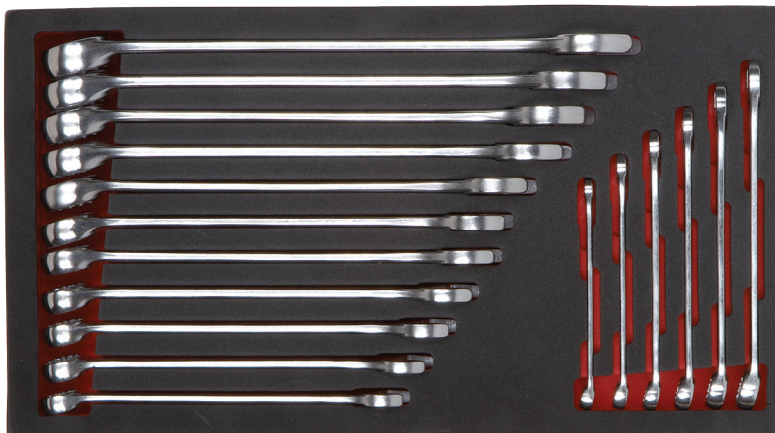

Item # **WR0965900401**

**17 Pieces**

**Contents:**

**Size (in mm)**

- 6, 7, 8, 9, 10, 11, 12, 13, 14, 15, 16, 17, 18, 19, 20, 21, 22
- Includes foam insert





A  
B  
C  
D  
E  
F  
G  
H  
I  
J  
K  
L  
M  
N  
O  
P  
Q  
R  
S  
T  
U  
V  
W  
X  
Y

## ALLEN KEYS

### Zebra Allen Keys, Long Version

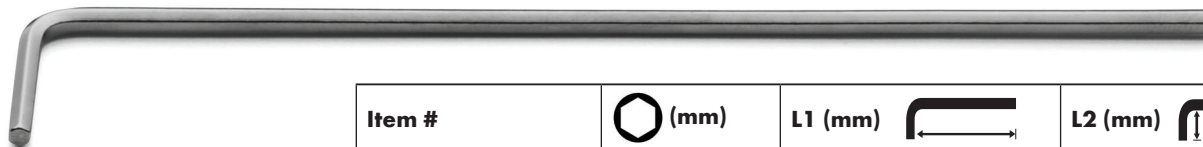

- Long version
  - Bright nickel-plated
  - Chamfered front edges
- Packing & Sold In: Each

Item #	⊙ (mm)	L1 (mm)	L2 (mm)
WR07153118	2.5	115	21
WR07153119	3.0	129	23
WR07153120	4.0	144	29
WR07153121	5.0	165	33
WR07153122	6.0	186	38
WR07153123	7.0	197	41
WR07153124	8.0	208	44
WR07153125	9.0	219	47
WR07153126	10.0	234	50
WR07153127	11.0	238	53
WR07153128	12.0	262	57
WR07153129	14.0	294	70
WR07153130	17.0	337	80

### Zebra Allen Keys, Short Version

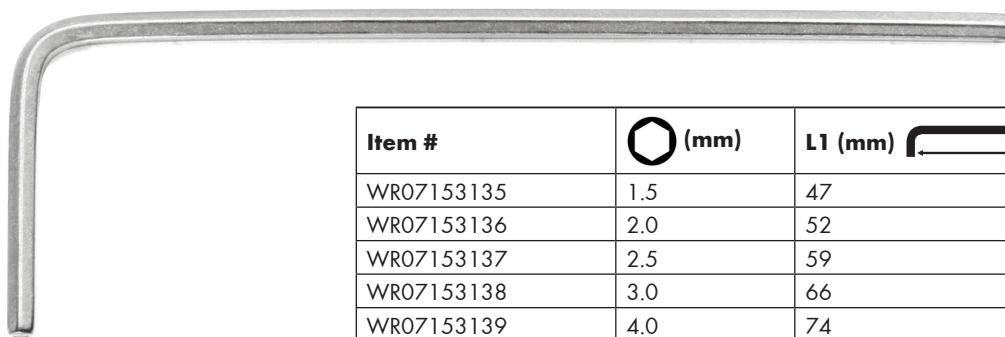

- Short version
  - Bright nickel-plated
  - Chamfered front edges
- Packing & Sold In: Each

Item #	⊙ (mm)	L1 (mm)	L2 (mm)
WR07153135	1.5	47	16
WR07153136	2.0	52	18
WR07153137	2.5	59	21
WR07153138	3.0	66	23
WR07153139	4.0	74	29
WR071531391	4.5	80	31
WR07153140	5.0	85	33
WR071531401	5.5	90	35
WR07153141	6.0	96	38
WR07153142	7.0	102	41
WR07153143	8.0	108	44
WR07153144	9.0	114	47
WR07153146	11.0	129	53
WR07153147	12.0	137	57
WR07153148	14.0	154	70
WR071531481	16.0	168	73
WR07153149	17.0	177	80
WR07153150	19.0	199	89
WR07153151	22.0	222	102

# ALLEN KEYS

## Zebra Allen Key Assortments



Short version

Long version

- 9 pieces, in plastic holder, short version
- Bright nickel-plated
- Chamfered front edges

Item #	Set	Contents (mm)
WR071531100	9-pcs	1.5, 2, 2.5, 3, 4, 5, 6, 8, 10

- 10 pieces, in plastic holder, short version
- Bright nickel-plated
- Chamfered front edges

Item #	Set	Contents (mm)
WR071531110	10-pcs	1.5, 2, 2.5, 3, 4, 5, 6, 8, 10, 12

- 9 pieces, in plastic holder, long version
- Bright nickel-plated
- Chamfered front edges

Item #	Set	Contents (mm)
WR071531120	9-pcs	1.5, 2, 2.5, 3, 4, 5, 6, 8, 10

## Zebra Torx Allen Key Assortment



- 8 pieces, in plastic holder
- TX socket
- Round blade
- Bright nickel-plated

Item #	Set	Contents
WR071536100	8-pcs	TX 9, 10, 15, 20, 25, 27, 30, 40

**A SCREWDRIVERS**

**ZEBRA Pistol Grip Ratchet Screwdriver with 6 Bit Magazine (Bits Not Included)**



**High-performance ratchet screwdriver**

- 3-position adjustment wheel, adjustable with one hand, easy to change direction while working without using the other hand
  - Magnet ensures a secure grip on bits and screws
  - 45 teeth, max. torque of up to 40 Nm
  - 2K grip for optimum ergonomic work
  - Can be used as a standard screwdriver in the straight position or as a pistol grip in the 60° position thanks to the adjustable handle LED technology
  - Working area is always well lit, lights the screw directly
  - Especially suitable for dark areas
  - Blade: Short bit holder blade with magnet, brushed chrome-plated
  - Output: DIN 3126-D 6.3
  - Sealing cap with bit magazine for a total of 6 bits (bits not included)
- Packing & Sold In: Each

Item #	Designation	Length (mm)
<b>1/4" Bits</b>		
WR0613714	Telesc. magn. holding force 600 g	150 - 530 mm

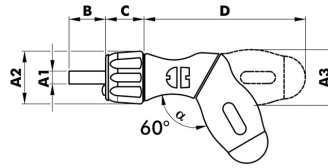

Item #	(in.)	A1 (mm)	A2 (mm)	A3 (mm)	B (mm)	C (mm)	D (mm)
WR06136400	1/4"	10	37	40	25	26	113

**ZEBRA 3K Hex Blade Phillips Head Screwdriver**

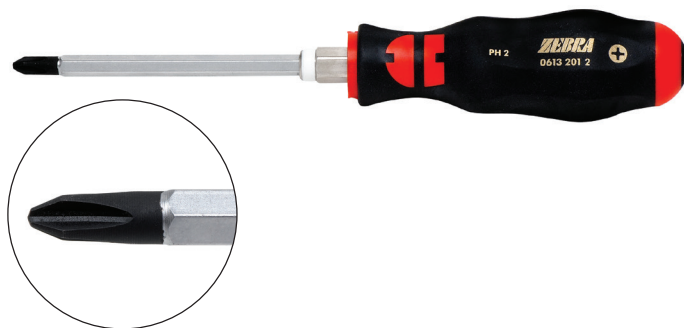

**Flexible 3K handle ensures perfect ergonomics, force transmission and working comfort**

**Screwdriver, Phillips Head**

- Blade: One-piece hexagon blade, brushed chrome-plated; wrench adapter matte nickel-plated, tempered, impact-resistant
  - Würth color coding system
  - Large impact cap
  - Tip: DIN 5260-PH, ISO 8764-PH with black point tip
- Packing & Sold In: Each

Item #	+			 (mm)	 (in.)
		A (mm)	B/C (mm)		
WR06132011	PH 1	80	96/31	5/8	3 1/8"
WR06132012	PH 2	100	106/35	6/10	4"
WR06132013	PH 3	150	114/38	8/13	6"

## SCREWDRIVERS

### ZEBRA 3K Hexagon Blade Slotted Head Screwdriver





**Flexible 3K handle ensures perfect ergonomics, force transmission and working comfort.**

**Screwdriver, flat slotted**

- Blade: One-piece hexagon blade, brushed chrome-plated; torque adjustment matte nickel-plated, tempered, impact-resistant
- Large impact cap
- Output: DIN 5264-A, ISO 2380 with black point tip

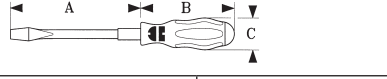
Packing & Sold In: Each



Item #	 (mm)			 (mm)	 (in.)
		A (mm)	B/C (mm)		
WR0613200035	0.6 x 3.5	80	83/27	4/-	1/8 x 3 1/16"
WR0613200045	0.8 x 4.5	90	96/31	5/8	3/16 x 3 3/5"
WR0613200055	1.0 x 5.5	100	96/31	6/10	7/32 x 4"
WR061320007	1.2 x 7.0	125	106/35	6/10	9/32 x 5"
WR061320009	1.6 x 9.0	150	114/38	8/13	11/32 x 6"
WR061320010	1.6 x 10.0	175	114/38	8/13	3/8 x 7"
WR061320012	2.0 x 12.0	200	114/38	10/16	1/2 x 8"

### ZEBRA 3K Slotted and Phillips Head Screwdriver Set - 5 Pieces



- 5 pieces, with three slotted and two Phillips head screwdrivers for the automotive and metalwork trades
- Flexible 3K handle ensures perfect ergonomics, power transmission and working comfort
- Impact caps

Packing & Sold In: Each

Item #	Contents		
WR06139015	5-pc. set	1.0x5.5 / 1.2x7.0 / 1.6x9.0 mm	PH 1   PH 2



## ZEBRA® 3K HANDLE

The flexible 3-component handle ensures an optimal, sensitive seat in the hand and allows connection with the robust design also the highest power transmission.

A  
B  
C  
D  
E  
F  
G  
H  
I  
J  
K  
L  
M  
N  
O  
P  
Q  
R  
S  
T  
U  
V  
W  
X  
Y

**A SCREWDRIVERS**

**ZEBRA 3K Torx Screwdriver Set (6 Pieces)**



**Item # WR06139036 6 piece set**

- 6 pieces, with flexible 3K handle for perfect ergonomics, power transmission and operating comfort
- Blade: Round, brushed chrome-plated
- Tip: TX socket with black point tip
- Würth color coding system
- Screw symbol printed on handle end for quick identification

Packing & Sold In: Each

	A (mm)	B/C (mm)	
TX 8	60	83/27	2 3/8"
TX 10	80		
TX 15		96/31	4"
TX 20	100		
TX 25		106/35	4 9/16"
TX 30	115		

**ZEBRA Slotted Screwdriver - Round Blade**



- Round blade
- Blade: Matte chrome-plated
- Tip: DIN 5264-A, ISO 2380, black point tip
- Standard: DIN 5265

Packing & Sold In: Each

Item #				
		A (mm)	B/C (mm)	
WR061323103	0.5 x 3.0	80	73/20	1/8" x 3 1/8"
WR0613231065	1.2 x 6.5	150	106/35	1/4" x 6"
WR061323110	1.6 x 10.0	200	114/38	3/8" x 8"

**ZEBRA Slotted Screwdriver - Round Blade, Short**



- Round blade, short
- Blade: Matte chrome-plated
- Tip: DIN 5264-A, ISO 2380, black point tip
- Standard: DIN 5265

Packing & Sold In: Each

Item #				
		A (mm)	B/C (mm)	
WR061325108	1.2 x 8.0	25	62/31	5/16 x 1"



## SCREWDRIVERS

### ZEBRA Slotted Screwdriver - Hexagon Blade, Impact Cap, Wrench Adapter

- Hexagon blade, impact cap
  - Large impact cap
  - Tip: DIN 5264-A, ISO 2380, black point tip
  - Wrench adapter
- Packing & Sold In: Each



Item #	A (mm)	B/C (mm)	(mm)	(in.)	
					A (mm)
WRO613321045	0.8 x 4.5	90	96/31	5 / 8	3/16 x 3 3/5"
WRO613321055	1.0 x 5.5	100	96/31	6 / 10	7/32 x 4"
WRO61332107	1.2 x 7.0	125	106/35	6 / 10	9/32 x 5"
WRO61332109	1.6 x 9.0	150	114/38	8 / 13	11/32 x 6"
WRO61332110	1.6 x 10.0	175	114/38	8 / 13	3/8 x 7"
WRO61332112	2.0 x 12.0	200	120/40.5	10 / 16	1/2 x 8"
WRO61332114	2.5 x 14.0	250	120/40.5	10 / 16	9/16 x 10"

### ZEBRA Slotted Screwdriver - Hexagon Blade, Wrench Adapter

- Hexagon blade and wrench adapter
  - Blade: Matte chrome-plated
  - Tip: DIN 5264-A, ISO 2380, black point tip
- Packing & Sold In: Each



Item #	A (mm)	B/C (mm)	(mm)	(in.)	
					A (mm)
WRO613421035	0.6 x 3.5	80	83/27	4 / -	1/8 x 3 1/16"
WRO613421004	0.8 x 4.0	90	96/31	5 / 8	5/32 x 3 5/8"
WRO613421055	1.0 x 5.5	100	96/31	5 / 8	7/32 x 4"
WRO613421065	1.2 x 6.5	125	106/35	6 / 10	1/4 x 5"
WRO61342108	1.6 x 8.0	150	114/38	8 / 13	5/16 x 6"
WRO61342110	1.6 x 10.0	175	114/38	8 / 13	3/8 x 7"
WRO61342112	2.0 x 12.0	200	120/40.5	10 / 16	1/2 x 8"

### ZEBRA Slotted Screwdriver - Hexagon Blade, Laser-cut Tip

- Laser-cut tip, hexagon blade
  - Ultra-secure seating of screwdriver in screw head
  - Better screw grip for improved torque transfer
  - Improved safety and less damage to screws and sensitive surfaces with less slippage
  - No repeated placement when screwing
  - Blade: Brushed chromium-plated
  - Tip: DIN 5264-A, ISO 2380, laser-cut tip, Black Point Tip
- Packing & Sold In: Each



Laser-cut tip profile  
Laser-cut blade tip for a sharp-edged surface structure



Item #	(mm)	A (mm)	B/C (mm)	(mm)	(in.)
WRO613424035	0.6 x 3.5	75	83/27	4 / -	1/8 x 3 1/16"
WRO61342404	0.8 x 4.0	90	96/31	4 / -	5/32 x 3 5/8"
WRO613424055	1.0 x 5.5	100	96/31	5 / 8	7/32 x 4"
WRO613424065	1.2 x 6.5	125	106/35	6 / 10	1/4 x 5"
WRO61342408	1.6 x 8.0	150	114/38	8 / 13	5/16 x 6"
WRO61342410	1.6 x 10.0	175	114/38	8 / 13	3/8 x 7"

**A SCREWDRIVERS**

**B ZEBRA Phillips Head Screwdriver - Hexagon Blade - Impact Cap - Wrench Adapter**



- Hexagon blade, impact cap, wrench adapter
  - Large impact cap
  - Tip: DIN 5260-PH, ISO 8764-PH, black point tip
  - Standard: DIN 5262, SMS SS 2831
- Packing & Sold In: Each

Item #	PH 1			 (mm)	 (in.)
		A (mm)	B/C (mm)		
WR06133221	PH 1	80	96/31	5 / 8	3 1/8"
WR06133222	PH 2	100	106/35	6 / 10	4"
WR06133223	PH 3	150	114/38	8 / 13	6"
WR06133224	PH 4	200	120/40.5	10 / 16	8"

**K ZEBRA Phillips Head Screwdriver - Round Blade - Short**



- Round blade, short
  - Blade: Matte chrome-plated
  - Tip: DIN 5260-PH, ISO 8764-PH, black point tip
  - Standard: DIN 5262, SMS SS 2831
- Packing & Sold In: Each

Item #	PH 1			 (in.)
		A (mm)	B/C (mm)	
WR06132521	PH 1	25	62/31	1 3/4"
WR06132522	PH 2			

**S ZEBRA Phillips Head Screwdriver - Round Blade**



- Round blade
  - Blade: Matte chrome-plated
  - Tip: DIN 5260-PH, ISO 8764-PH, black point tip
  - Standard: DIN 5262, SMS SS 2831
- Packing & Sold In: Each

Item #	PH 1			 (in.)
		A (mm)	B/C (mm)	
WR061323201	PH 1	80	96/31	3 1/8"
WR061323202	PH 2	100	106/35	4"
WR061323203	PH 3	150	114/38	6"
WR061323204	PH 4	200	120/41	8"

## SCREWDRIVERS

### ZEBRA Phillips Head Screwdriver - Hexagon Blade - Wrench Adapter



- Hexagon blade, wrench adapter
  - Blade: Matte chrome-plated
  - Tip: DIN 5260-PH, ISO 8764-PH, black point tip
- Packing & Sold In: Each



Item #	+			 (mm)	 (in.)
		A (mm)	B/C (mm)		
WR06134221	PH 1	80	96/31	5 / 8	3 1/8"
WR06134222	PH 2	100	106/35	6 / 10	4"
WR06134223	PH 3	150	114/38	8 / 13	6"
WR06134224	PH 4	200	120/40.5	10 / 16	8"

### ZEBRA Phillips Head Screwdriver - Laser-cut Tip - Hexagon Blade - Wrench Adapter



- Laser-cut tip, hexagon blade, wrench adapter
  - Ultra-secure seating of screwdriver in screw head
  - Better screw grip for improved torque transfer
  - Less slippage means improved safety as well as less damage to screws and sensitive surfaces
  - No repeated placement when screwing
  - Blade: Brushed chrome-plated
  - Tip: DIN 5260-PH, ISO 8764-PH, laser-cut tip, black point tip
- Packing & Sold In: Each



Laser-cut tip profile  
Laser-cut blade tip for a sharp-edged surface structure

Item #	+			 (mm)	 (in.)
		A (mm)	B/C (mm)		
WR06134251	PH 1	80	96/31	5 / 8	3 1/8"
WR06134252	PH 2	100	106/35	6 / 10	4"
WR06134253	PH 3	150	114/38	8 / 13	6"

### ZEBRA Torx Screwdriver - Round Blade



- Blade: Round blade, matte chrome-plated
  - Tip: TX socket, black point tip
- Packing & Sold In: Each



Item #		Blade Length (mm)
WR061343410	TX 10	80
WR061343415	TX 15	
WR061343420	TX 20	100
WR061343425	TX 25	
WR061343427	TX 27	115
WR061343430	TX 30	
WR061343440	TX 40	130
WR061343445	TX 45	

A  
B  
C  
D  
E  
F  
G  
H  
I  
J  
K  
L  
M  
N  
O  
P  
Q  
R  
S  
T  
U  
V  
W  
X  
Y

## SCREWDRIVERS

### ZEBRA Torx Screwdriver - Round Blade - Long Length



- Blade: Round blade, matte chrome-plated
  - Tip: TX socket, black point tip
- Packing & Sold In: Each

Item #	TX 10			 (in.)
		A (mm)	B/C (mm)	
WR061346410	TX 10	250	83/27	10"
WR061346420	TX 20		96/31	
WR061346430	TX 30		106/35	

### ZEBRA Screwdriver Set - Round Blade - Phillips/Slotted head - 6 Pieces



Item # **WR061392326** 6 piece set

- 0.6 x 3.5 x 100 mm, 1.0 x 5.5 x 125 mm, 1.2 x 6.5 x 150 mm, 1.2 x 8.0 x 175, PH1, PH2
- Packing & Sold In: Each

Includes:

(mm)		
0.6 x 3.5 x 100		PH 1
1.0 x 5.5 x 125		PH 2
1.2 x 6.5 x 150		
1.2 x 8.0 x 175		

### ZEBRA Screwdriver Set - Hexagon Blade - Phillips/Slotted head - With Wrench Adapter- 6 Pieces



Item # **WR061394226** 6 piece set

- Hexagon blade and wrench adapter for automotive and metalwork trades
  - Blade: Brushed chrome-plated
  - 1 each of slotted screwdriver with hexagon blade and torque adjustment
  - 0.6 x 3.5 x 75; 1.0 x 5.5 x 100; 1.2 x 6.5 x 125; 1.6 x 8.0 x 150
  - 1 each of PH screwdriver with hexagon blade and torque adjustment PH 1; PH 2
- Packing & Sold In: Each

Includes:

Item #	(mm)		Item #	
WR0613421035	0.6 x 3.5 x 75		WR06134221	PH 1
WR0613421055	1.0 x 5.5 x 100		WR06134222	PH 2
WR0613421065	1.2 x 6.5 x 125			
WR061342108	1.6 x 8.0 x 150			



## SCREWDRIVERS

### ZEBRA Torx Screwdriver Assortment - 7 Pieces



- 7 Screwdrivers: TX 10; 15; 20; 25; 27; 30; 40
- Foam drawer insert

**7 Piece Set**

**Item #: WR0965900502**



### ZEBRA Torx Screwdriver Set 8 Pieces



- 1 Screwdriver set TX 8 pcs.
- Blade: Round blade, brushed chromium-plated, tip: TX socket, black point tip

**8 Piece Set**

**Item #: WR06139348**

	Blade length (mm)
TX 10	80
TX 15	
TX 20	100
TX 25	
TX 27	115
TX 30	
TX 40	130
TX 45	



### ZEBRA Multi Screwdriver Assortment - 8 Pieces

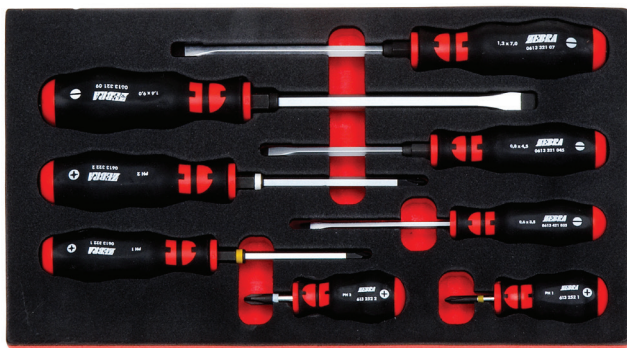

- 6 screwdrivers with one-piece hexagon blade 0.6 x 3.5; 0.8 x 4.5; 1.2 x 7.0; 1.6 x 9.0; PH1; PH2
- 2 screwdrivers, short, PH1; PH2
- Foam drawer insert

**8 Piece Set**

**Item #: WR0965900501**



**A SCREWDRIVERS**

**ZEBRA Screwdriver with 1/4" Square Tip - Includes Ratchet Adapter**



- One-piece blade
  - Blade: Round, bright chrome-plated
  - Tip: DIN 3120-A 6.3
  - With ratchet adapter
- Packing & Sold In: Each



Item #	(in.)	Diagram		(in.)
		A (mm)	B/C (mm)	
WRO613430310	1/4"	110	106/35	4 3/8"

**ZEBRA Screwdriver with 1/4" Square Tip**



- Blade: Round, bright chrome-plated
  - Tip: DIN 3126-D 6.3
- Packing & Sold In: Each



Item #	(in.)	Diagram		(in.)
		A (mm)	B/C (mm)	
WRO613430311	1/4"	110	106/35	4 3/8"

**ZEBRA Screwdriver with 1/4 Inch Bit Chuck**



- Blade: Round with magnet
  - Head: Bright nickel-plated
  - Tip: DIN 3126-D 6.3
- Packing & Sold In: Each



Item #	(in.)	Diagram		(in.)
		A (mm)	B/C (mm)	
WRO61343031	1/4"	100	106/35	4"

**ZEBRA Screwdriver with 1/4 Inch Bit Chuck**



- Flexible shaft
  - Blade: Round, bright chrome-plated
  - Tip: DIN 3120-A 6.3
- Packing & Sold In: Each



Item #	(in.)	Diagram		(in.)
		A (mm)	B/C (mm)	
WRO6134733	1/4"	150	106/35	6"

# SCREWDRIVERS

## Zebra Ratchet Magazine Screwdriver (Includes 12 Bits)



Magnetic blade mount for 1/4" bits

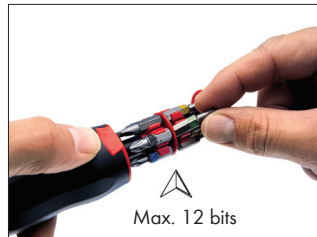

Easy removal of the desired bit



Secure closing thanks to "snap lock"

Designation	Tip
<b>Included Bits</b>	
PH 1	
PH 2	
TX 10	
TX 15	
TX 20	
TX 25	
TX 30	
Allen 4 mm	
Allen 5 mm	
Allen 6 mm	
Slotted, 0.6 x 4.5 mm	
1/4"	

### Item # WR06136103

- Equipped with 12 bits
- Blade: Circular blade with magnet, bright chrome-plated
- Tip: DIN 3126-D 6.3
- 28 teeth, max. torque over 20 Nm.
- Advantage of the ratchet function is no need to reposition hand. This enables fast efficient operation in any assembly situation. Bit magazine for max. 12 bits
- Extendable, rotating magazine lets you find the bit you need quickly.
- 1/4" bit with color coding system

Packing & Sold In: Each

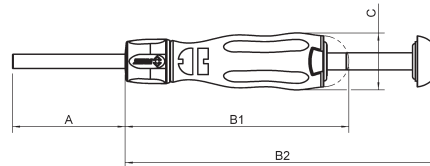

(in.)	A (mm)	B1/B2 (mm)	C (mm)
1/4"	80	147/207	37.5

## ZEBRA Mini Ratchet Screwdriver (Includes 11 Bits)



- 10-piece bit strip + PH2 bit
- 2K handle
- Blade: Short bit holder blade with magnet, bright chrome-plated
- Tip: DIN 3126-D 6.3
- For high torque applications in tight spaces

Packing & Sold In: Each

Bits included (1 each):	
	1/4"
	5.5 mm
	4 mm, 5 mm
	PH 1, PH 2
	TX 10, TX 15, TX 20, TX 25, TX 30



Item #	(in.)	A (mm)	B (mm)	C (mm)	A2 (mm)
WR061363050	1/4"	26	70	38	20

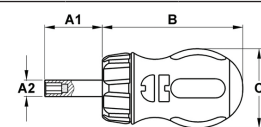

**A SCREWDRIVERS, T-HANDLE**

**ZEBRA T-Handle Hexagon Socket Wrench**



- For hexagon head screws
  - Blade: Round, chrome-plated
  - Tip: DIN 475/2
  - Inner bore for protruding threaded shafts
  - Standard: DIN 3125
- Packing & Sold In: Each

Item #	(mm)			
		A (mm)	B/C (mm)	A (in.)
WRO61312010	10	125	35/104	5"
WRO61312013	13		39/117	
WRO61312016	16			35/104
WRO61312017	17	9 3/16"		
WRO61312108	8		200	
WRO61312110	10			
WRO61312113	13			
WRO61312208	8	230	12"	
WRO61312210	10			
WRO61312213	13			

**ZEBRA T-Handle Socket Wrench Set (5 Pieces)**



Item # **WRO61391205** 5 piece set

- Blade: Circular, nickel-plated
  - Output: DIN 475/2
  - Inner bore for protruding threaded shafts
  - Standard: DIN 3125
- Packing & Sold In: Each

Includes:

Item #	(mm)	Blade Length (mm)
Only available in set	6	125
WRO61312007	7	
WRO61312008	8	
WRO61312010	10	
WRO61312013	13	



## SCREWDRIVERS, T-HANDLE

### ZEBRA T-Handle Torx Head Screwdriver with Side Hex Tip

- Integrated side tip
- Effortless tightening and loosening of screw connections
- Particularly suitable for rusted and seized screw connections
- High-quality blade
- Matte chrome-plated hexagon blade for optimal corrosion protection and long service life
- High-quality special steel ensures optimal balance of ductility and wear resistance
- One-piece blade
- Resistant even to extremely high stresses
- Multi-component handle comprising solid core and soft casing
- Highly slip-proof special black plastic ensures maximum torque transfer
- Solid core and soft casing ensure rigidity and a secure grip
- Ergonomically adapted handle for a comfortable grip and fatigue-free operation
- Integrated drilled hole for storage on tool rack
- Black point tip
- Higher torque and a precise fit
- Output: For TX socket

Packing & Sold In: Each



Item #	Torx Head (mm)	Diagram Labels		
		A (mm/in.)	B/C (mm)	Length of Side Hex Tip (mm)
WR061314009	TX 9	100/4"	27/82	13"
WR061314010	TX 10			
WR061314015	TX 15			
WR061314020	TX 20	200/8"	35/105	17"
WR061314025	TX 25			
WR061314027	TX 27			
WR061314030	TX 30			
WR061314040	TX 40			
WR061314045	TX 45			

### ZEBRA T-Handle Torx Socket Screwdriver Set (6 Pieces)



Item # **WR061391406** 6 piece set

- For TX socket, with side output
- Integrated side tip
- Effortless tightening and loosening of screw connections
- High-quality blade
- Matte chrome-plated hexagon blade for optimal corrosion protection and long service life
- Multi-component handle comprising solid core and soft casing
- Highly slip-proof special black plastic ensures maximum torque transfer
- Integrated drilled hole for storage on tool rack.
- Contents: 6 pcs.
- 6 T-handle screwdrivers for TX socket (TX 10, 15, 20, 25, 30, 40)

Packing & Sold In: Each

Includes:

Item #	Torx Head	Blade Length (mm)
WR061314010	TX 10	100
WR061314015	TX 15	
WR061314020	TX 20	200
WR061314025	TX 25	
WR061314030	TX 30	
WR061314040	TX 40	



**A SCREWDRIVERS, T-HANDLE**

**ZEBRA T-Handle Ball Head Screwdriver with Side Hexagon Tip**





**Features:**

- Integrated side tip
- High-quality blade
- One-piece blade
- Multi-component handle comprising solid core and soft casing
- Black point tip

Packing & Sold In: Each

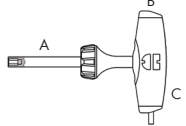

Item #	 (mm)			Length of Side Hex Tip (mm)	Tip
		A (mm/in.)	B/C (mm)		
WR061313005	5	150/6"	35/105	17	Ball Head Tip
WR061313006	6				
WR061313008	8				
WR061313105	5	200/8"	39/117	22	
WR061313106	6				
WR061313108	8				
WR061313110	10				

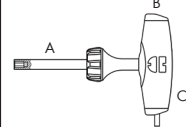
Item #	 (mm)			Length of Side Hex Tip (mm)	Tip
		A (mm/in.)	B/C (mm)		
WR0613132025	2.5	150/6"	27/82	13	Hex Head Tip
WR061313203	3				
WR061313204	4				
WR061313205	5	35/105	17		
WR061313206	6				
WR061313208	8				
WR061313303	3	200/8"	27/82	13	
WR061313304	4				
WR061313305	5				
WR061313306	6	35/105	17		
WR061313308	8				
WR061313310	10			39/117	22

**ZEBRA T-Handle Hex Blade Screwdriver Set (6 Pieces)**



Item # **WR061391306** 6 piece set

- 1 each of T-handle wrench with ball head hexagon socket, size 5 mm, 6 mm, 8 mm
- 1 each of T-handle wrench with hexagon socket, size 2.5 mm, 3 mm, 4 mm

Packing & Sold In: Each

**Includes:**



Item #	 Contents (mm)	Blade Length (mm)	Tip
WR0613132025	2.5	150	Hex Head Tip
WR061313203	3		
WR061313204	4		
WR061313005	5	150	Ball Head Tip
WR061313006	6		
WR061313008	8		

## SCREWDRIVERS, T-HANDLE

### ZEBRA T-Handle, Torx Socket Set - In Sheet Steel Rack - 7 Pieces



Item #: **WR06139147** 7 piece set

- In sheet steel rack
- Integrated side output
- Effortless tightening and loosening of screw connections
- Particularly suitable for rusted and seized screw connections
- Multi-component handle comprising solid core and soft casing
- Ergonomically adapted handle for a comfortable grip and effortless work
- Integrated drilled hole for storage on tool rack
- Black Point tip
- Higher torque and a precise fit
- One-piece blade
- Resistant even to extremely high stresses
- Contents: 7 pieces
- 1 each of T-handle screwdriver TX 10; TX 15; TX 20; TX 25; TX 30; TX 40; TX 45

Packing & Sold In: Each

Includes:

Item #	(mm)	Blade Length (mm)
WR061314010	TX 10	100
WR061314015	TX 15	
WR061314020	TX 20	200
WR061314025	TX 25	
WR061314030	TX 30	
WR061314040	TX 40	
WR061314045	TX 45	

### ZEBRA T-Handle Ratchet Screwdriver Set with 11 piece bits

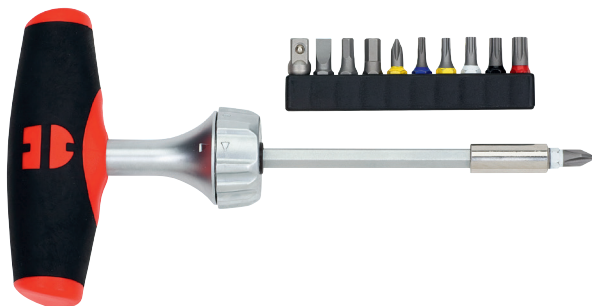

- With 10-piece bit strip + PH2 bit
- Robust ratchet function with 45 teeth
- Max. torque of up to 40 Nm
- 3-position adjustment wheel is adjustable with one hand
- Easy, one-handed change of direction while working

Packing & Sold In: Each

Bits included (1 each):	
	1/4"
	5.5 mm
	4 mm, 5 mm
	PH 1, PH 2
	TX 10, TX 15, TX 20, TX 25, TX 30

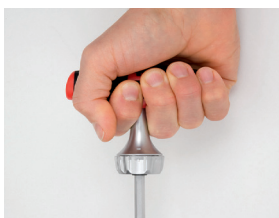

**Ratchet function**  
Very rugged design, max. torque up to 40 Nm (29.5 lb-ft).

Item #	(in.)				
		A (mm)	B (mm)	C (mm)	A2 (mm)
WR061363040	1/4"	95	85	100	10

A  
B  
C  
D  
E  
F  
G  
H  
I  
J  
K  
L  
M  
N  
O  
P  
Q  
R  
S  
T  
U  
V  
W  
X  
Y

**A BITS & ACCESSORIES**

**B ZEBRA Flexible Bit Holder Length 175mm - 1/4" Drive**



Item #	Drive (in.)	Drive Type	Tip Size (in.)	Tip Type	Length (mm)
WR0613713	1/4"	Outer Hexagon	1/4"	Internal Hexagon Socket	175

**F Ratchet Bit Assortment - 38 Pieces**



Bit set especially for automobiles and commercial vehicles, 38 pieces

- ZEBRA ratchet for 10 mm bits
- Additional ZEBRA adapter allows use of a 1/2" ratchet
- Supplied in a metal box with high quality interior foam compartment with clamping effect

Packing & Sold In: Each; Replacement bits sold in multiples of 5 each.

Item #	Description
WR096512370	Ratchet Bit Set

Includes:

Item #	Destination	Drive	Length
WR071412100	ZEBRA Ratchet for 10mm bits		175mm
WR07151303	ZEBRA Adapter for 1/2" ratchet		37mm
WR061478820	TX 20 with hole		30mm
WR061478825	TX 25 with hole		
WR061478827	TX 27 with hole		
WR061478830	TX 30 with hole		
WR061478840	TX 40 with hole		
WR061478845	TX 45 with hole		
WR061478850	TX 50 with hole		
WR061478855	TX 55 with hole		75mm
WR0614788120	TX 20		
WR0614788125	TX 25		
WR0614788127	TX 27		
WR0614788130	TX 30		
WR0614788140	TX 40		
WR0614788145	TX 45		
WR0614788150	TX 50		
WR0614788155	TX 55		

Item #	Destination	Drive	Length
WR0614788240	TX 40		120 mm
WR0614788245	TX 45		
WR0614788250	TX 50		
WR0614788305	Hexagon socket M5		30 mm
WR0614788306	Hexagon socket M6		
WR0614788307	Hexagon socket M7		
WR0614788308	Hexagon socket M8		
WR0614788310	Hexagon socket M10		
WR0614788312	Hexagon socket M12		
Only Available in Set	Triple Square M5		30 mm
WR0614788406	Triple Square M6		
WR0614788408	Triple Square M8		
WR0614788410	Triple Square M10		
WR0614788412	Triple Square M12		75 mm
Only Available in Set	Triple Square M6		
WR0614788508	Triple Square M8		
WR0614788510	Triple Square M10		30 mm
Only Available in Set	Triple Square M12		
WR0614788902	PH 2		
WR0614788903	PH 3		30 mm

- ① Ratchet with short 10 mm bit
- ② 1/2" ratchet with adapter

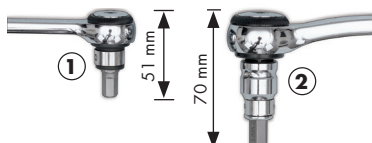



**BITS & ACCESSORIES**

**Drive & Insert Bits**



Item #	Magnetic	Tip Size	Overall Length	Sold In
<b>Phillips Drive Bits</b>				
WR0614176274	No	#1	1"	1 each
WR0614176461	No	#2	1"	1 each
WU92210	No	#2	1"	1 each
WU92220	No	#2	2"	1 each
WU92230	No	#2	2-3/4"	1 each
WR0614176648	No	#3	1"	1 each
<b>Pozi Drive Bits</b>				
WR0614176652	No	#2	1"	10 each
WR0614176653	No	#3	1"	1 each
<b>Square Drive Bits</b>				
LCTBS2X1RS	No	#2	1"	1 each
WU90220	No	#2	2"	1 each
LCTBS2X3RS	No	#2	3"	1 each
WU90240	No	#2	4"	1 each
LCTBS2X6RS	No	#2	6"	1 each
<b>Powerdriv Hex Bits</b>				
WR061417693	No	#3	25mm	1 each
WR061417694	No	#4	25mm	1 each
WR061417695	No	#5	25mm	1 each
WR061417696	No	#6	25mm	1 each
<b>Torx Bits</b>				
WRT20X2	No	T20	2"	1 each



**Painted Square Drive Bits**

- Makes it easy to identify the right bit (tip is not painted)



Item #	Color	Tip Size	Overall Length	Sold In
WU91210	Red	#2	1"	1 each
WU91220	Red	#2	2"	1 each
WU91230	Red	#2	3"	1 each
WU91260	Red	#2	6"	1 each



**AW® ASSY DRIVE Bits**

- For use with ASSY drive screws

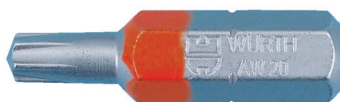

Item #	Tip Size	Overall Length	Sold In
WRAW10	#10 Purple	1"	1 each
WRAW20	#20 Orange	1"	1 each
WRAW20-4	#20 Orange	4"	1 each
WRAW20-6	#20 Orange	6"	1 each
WRAW25	#25 Green	1"	1 each



A  
B  
C  
D  
E  
F  
G  
H  
I  
J  
K  
L  
M  
N  
O  
P  
Q  
R  
S  
T  
U  
V  
W  
X  
Y

**A BITS & ACCESSORIES**

**B 1/4 Inch Phillips Bit (Hex Quick Change)**

Packing & Sold In: Each



Item #	Designation	Phillips-Head System	Tip	Drive	Length (mm)
WR0614100201	PH 2	MSVM 2 - Magazine attachment - Makita		1/4" 	152
WR0614100111		MSVW 1 - Magazine attachment - Wurth / Bosch			155
WR0614100211		MSVW 2 - Magazine attachment - Wurth / Bosch			168
WR0614100212		S50-TB - Magazine screw attachment - Wurth/Kress/Eibenstock			176.5

**J Insert Bit Holder with Quick Change Chuck**

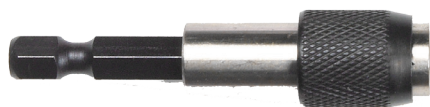

- A slight forward motion of the locking sleeve unlocks the bit for a quick change

Item #	Overall Length
<b>Magnetic</b>	
WU99010	2-1/4"
WR614176708	3"
<b>Non-Magnetic</b>	
WR0614176711	2"

**R Insert Bit Holder, Magnetic, One Touch Release**



- Soft push on the button, the bit will shoot forward due to the internal spring for easy removal
- Stainless steel housing

Item #
WR0614176638

**W Insert Bit Holder, Magnetic**



- High energy magnet helps alleviate the problem of lost bits

Item #	Overall Length	Brand
WR0614176702	3"	Wurth

**BITS & ACCESSORIES**



**Right Angle Drill Attachment, Magnetic, 1/4" Bit Mount with Quick Change Chuck**



- Suitable for use with electric drills and battery operated driver drills
- Specially hardened steel enables maximum torque, with a maximum speed of 2,000 RPM's
- Secure hold and 360° step-free adjustable handle
- Compact design is perfectly suited for screwing in cramped and hard-to-reach places

<b>Item #</b>
WR06149000



**Magnetic Universal Bit Assortment (90 Pieces)**



- Includes standard drive styles and safety screws, 1/4" drive magnetic ratchet adapter and sturdy metal box
- Comes in foam insert to keep the bits nicely organized

<b>Item #</b>
WR0614250500

**ZEBRA Universal Bit Assortment (105 Pieces)**

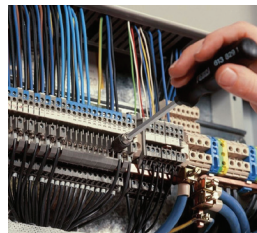

**Item # WR0614250300 105 piece set**

**Comprehensive 1/4" bit assortment with the most common standard and security bits in short and long versions**



- A majority of the bits are for security screws. Used wherever unauthorized loosening is to be prevented
- Includes two bit adapters and one screw hook
- The solution for virtually all screw types
- In sturdy metal box with foam insert

**Areas of Application:**

Public facilities, motor vehicle and motorcycle sector, plumbing applications, construction industry, electrical, electronics and machine sector

**A RATCHETS**

**ZEBRA Ratchet with Rotary Disc Reverse**



**Rotary Disc Reverse**

**Fine tooth rotary disc with 72 teeth; 5° angle of rotation**

- Compact, narrow head
- Simple changeover from clockwise to counterclockwise rotation
- Chamfered square – easier removal of socket wrench inserts
- Offset ratchet body for more hand freedom

Packing & Sold In: Each



Item #	Description	Tip Size	Length (mm)
WR07120140	Ratchet with rotary disc reverse	1/4"	138
WR07120380		3/8"	175
WR07120120		1/2"	250

**ZEBRA 1/4 Inch Ball-Head 3-in-1 Ratchet**



- Multi-functional spherical ratchet with adjustable handle
- Drive: 6.3 - 1/4"
- Standard: DIN 3122, ISO 3315
- Head: 72 teeth, angle of rotation: 5°, joint can be rotated 270°
- Handle: Two-component handle, straight or adjustable 90° as T-handle

Packing & Sold In: Each



**3 in 1!**  
Can be used like a conventional ratchet, as a screwdriver or a T-handle!

Item #	Length (mm)	Ratchet head height (mm)	Ratchet diameter (mm)
WR071201405	145	26.5	20





## RATCHETS

### ZEBRA 1/4 Inch Lever Reversible Ratchet, Dust Protected

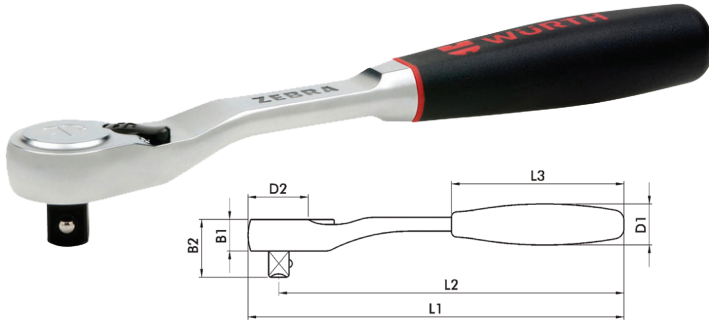

**Dust-protected ratchet for a long service life even under difficult working conditions**



- Standard: DIN 3122, ISO 3315
- Reversing lever for clockwise and counterclockwise rotation
- Geometry: Ratchet body with depressed center for more freedom of movement
- Material: Chrome-vanadium steel
- Grip Handle Material: 2-component plastic
- With 72 teeth, 5° angle of rotation

Packing & Sold In: Each

Item #	Tip Size	L1 (mm)	L2 (mm)	L3 (mm)	B1 (mm)	B2 (mm)	D1 (mm)	D2 (mm)
WR071201403	1/4"	136	125	61	13	22	16	21
WR071203803	3/8"	177	160	79	16	29	21	29
WR071201203	1/2"	253	240	115	19	36	26	38

### ZEBRA 10 mm Ratchet Tool

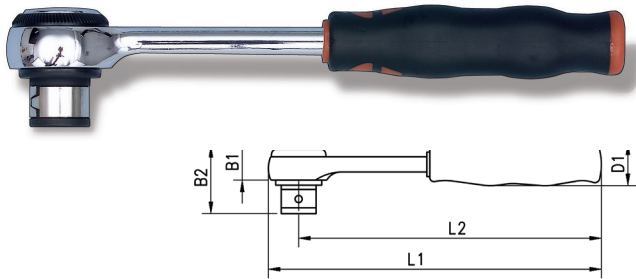

**Features:**

- Head: 72 teeth, swivel angle 5°, round, compact head
- Shaft: Chrome-plated, high-grip 2-component handle



Packing & Sold In: Each

Item #	Destination	Drive	L1 mm	L2 mm	B1 mm	B2 mm	D1 mm	D2 mm	Length
WR071412100	Ratchet for 10mm bits		175	160	19	33	26	20	175mm
WR07151303	Adapter for 1/2" ratchet		-	-	-	-	-	-	37mm

### ZEBRA 1/2 Inch Jointed Handle



**Features:**

- Standard: DIN 3122, ISO 3315
- Joint: Rotatable through 180°, head can be used in any desired position
- Flexible operation even in obstructed areas
- Powerful breaking and tightening ability
- Chrome-plated



Packing & Sold In: Each

Item #	Length (mm)	Tip size (in.)	Handle diameter (mm)	Width of head (mm)
WR0712130102	490	1/2"	35	20

A  
B  
C  
D  
E  
F  
G  
H  
I  
J  
K  
L  
M  
N  
O  
P  
Q  
R  
S  
T  
U  
V  
W  
X  
Y

**A SOCKETS**

**ZEBRA 1/4 Inch Socket Bits**



- Socket Wrench, Slotted
- Surface: Chrome-plated, polished/matte
- Drive: 1/4" square socket, ball catch groove
- Tip: DIN 5264, slotted
- Packing & Sold In: Each

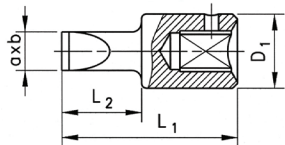

Item #	(mm)	L1 (mm)	L2 (mm)	D1 (mm)
WR071511735	0.6 x 3.5	32	12	12
WR071511755	1.0 x 5.5			
WR071511765	1.2 x 6.5			
WR071511780	1.2 x 8.0			



- Socket Wrench, Phillips
- Surface: Chrome-plated, polished/matte
- Drive: 1/4" square socket, ball catch groove
- Tip: ISO 8764-PH
- Packing & Sold In: Each

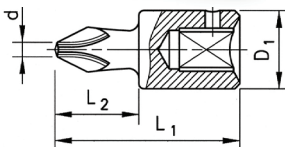

Item #	(mm)	L1 (mm)	L2 (mm)	D1 (mm)
WR071511801	PH 1	32	12	12
WR071511802	PH 2			
WR071511803	PH 3			



- Socket Wrench, Hexagon
- Surface: Chrome-plated, polished/matte
- Drive: 1/4" square drive, ball catch groove
- Output: For hexagon socket, DIN 7422
- Packing & Sold In: Each

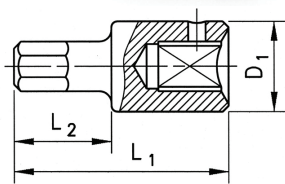

Item #	mm	L1 (mm)	L2 (mm)	D1 (mm)
WR071511503	3	32	12	12
WR071511504	4			
WR071511505	5			
WR071511506	6			
WR071511507	7			
WR071511508	8			

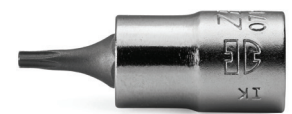

- Socket Wrench, Torx
- Surface: Chrome-plated
- Drive: 1/4" square socket, ball catch groove
- Tip: For TX screws
- Packing & Sold In: Each

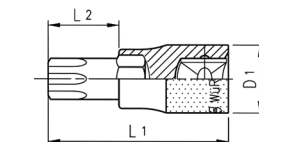

Item #	(mm)	L1 (mm)	L2 (mm)	D2 (mm)
WR071511310	2.72 10	32	12	12
WR071511315	3.26 15			
WR071511320	3.84 20			
WR071511325	4.40 25			
WR071511327	4.96 27			
WR071511330	5.49 30			
WR071511340	6.60 40			



**SOCKETS**

**ZEBRA 1/4 Inch Extension**

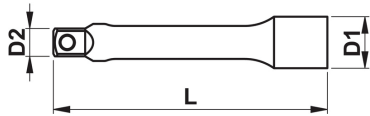

- Surface: Chrome-plated, polished
  - Drive: 1/4" square drive, ball catch groove
- Packing & Sold In: Each



Item #	Length (mm)	D1 (mm)	D2 (mm)
WR0713118101	25	12	8.3
WR0713118102	53		
WR0713118104	101		
WR0713118106	152		
WR0713118110	250		

**ZEBRA 1/2 Inch Angled Extension**

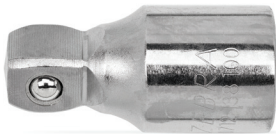

**Item #: WR0712138100**

- For working in hard-to-reach places
  - Standard: DIN 3123, ISO 3316
  - Surface: Chrome-plated
  - Drive: 1/2" square socket, ball catch groove
  - Tip: 1/2" square head
  - Length: 50 mm
  - Angular movement of up to 8"
  - Tip: 1/4" square head
- Packing & Sold In: Each



**ZEBRA 3/8 Inch Extension**



**Item #: WR0713128105**

- Standard: DIN 3123, ISO 3316
  - Surface: Chrome-plated
  - Drive: 3/8" square socket, ball catch groove
  - Tip: 3/8" square head
  - Length: 125 mm
- Packing & Sold In: Each



**ZEBRA 1/2 Inch Extension**

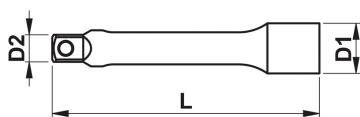

- Standard: DIN 3123, ISO 3316
  - Surface: Chrome-plated
  - Drive: 1/2" square socket, ball catch groove
  - Tip: 1/2" square head
- Packing & Sold In: Each



Item #	Length (mm)	D1 (mm)	D2 (mm)
WR0712138102	53	23	15
WR0712138103	75		
WR0712138105	125		
WR0712138110	250		
WR0712138118	457		17

A  
B  
C  
D  
E  
F  
G  
H  
I  
J  
K  
L  
M  
N  
O  
P  
Q  
R  
S  
T  
U  
V  
W  
X  
Y

**A SOCKETS**

**ZEBRA 1/2 Inch PowerDriv (12-Point) Socket**

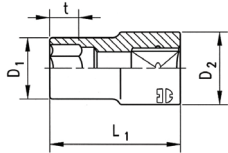

**Metric, short**

- Standard: DIN 3124, ISO 2725
- Surface: Chrome-plated, ground/matte
- Drive: 1/2" square socket, ball catch groove
- Tip: POWERDRIV®

Packing & Sold In: Each

Item #	(mm)	L1 (mm)	D1 (mm)	D2 (mm)	t (mm)
WR0712133108	8	36	12.9	21.9	7
WR0712133109	9		14		8
WR0712133110	10		15.4		10
WR0712133111	11		16.6		
WR0712133112	12		17.9		11
WR0712133113	13		19.1		
WR0712133114	14		20.4		
WR0712133115	15		21		
WR0712133116	16		22.5		16
WR0712133117	17		24		
WR0712133118	18	25.4	23.5		
WR0712133119	19	26.5	24.7		
WR0712133120	20	27.9	25.5	19	
WR0712133121	21	38	28.5		26
WR0712133122	22		29.9		26.5
WR0712133123	23		31.2		27.7
WR0712133124	24		32	29	
WR0712133126	26	44	35	31.5	24
WR0712133127	27		36	32.2	
WR0712133128	28		37.7	33.5	
WR0712133130	30		40	36	
WR0712133132	32	42	38.1	25	
WR0712133134	34	47	45.5		40
WR0712133136	36	50	48	42	28.5

**ZEBRA 1/2 Inch Socket Bits - Torx**

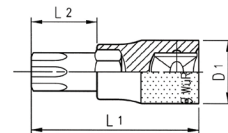

- Torx, short
- Design: Short
- Surface: Chrome-Plated
- Drive: 1/2" square socket, ball catch groove
- Tip: For TX screws

Packing & Sold In: Each

Item #	(mm)	L1 (mm)	L2 (mm)	D1 (mm)
WR071513320	20	60	20	22.5
WR071513325	25			
WR071513327	27			
WR071513330	30			
WR071513340	40			
WR071513345	45			
WR071513350	50			
WR071513355	55			
WR071513360	60			
WR071513370	70			25
WR071513380	80	28		
WR0715133100	100	80	42	26



**SOCKETS**

**ZEBRA 1/2 Inch PowerDriv (Hexagon) Socket**

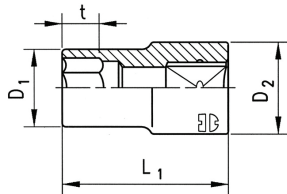

- Metric, long
- Surface: Chrome-plated, polished/matte
- Drive: 1/2" square socket, ball catch groove
- Tip: **POWERDRIV**® (Hexagon)

Packing & Sold In: Each

Item #	(mm)	L1 (mm)	D1 (mm)	D2 (mm)	t (mm)
WR0712132310	10	77	15.4	21.8	25.0
WR0712132311	11		16.6		
WR0712132312	12		17.9		
WR0712132313	13		19.1		
WR0712132314	14		20.4		
WR0712132315	15		21.6	21.6	35.5
WR0712132316	16		22.6	22.6	
WR0712132317	17		24.1	24.1	
WR0712132318	18		25.4	25.4	
WR0712132319	19		26.5	26.5	
WR0712132320	20		27.8	27.8	
WR0712132321	21		28.2	28.2	
WR0712132322	22		29.7	29.7	
WR0712132323	23		31.2	27.0	
WR0712132324	24		31.7		
WR0712132326	26		35.4	33.0	
WR0712132327	27		35.7		
WR0712132328	28	37.6			
WR0712132330	30	39.8	33		
WR0712132332	32	41.9	34		

**ZEBRA 1/2 Inch Torx Socket Bits, Long**

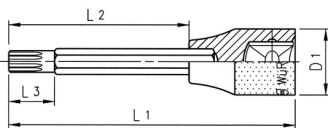

- Torx, long
- Surface: Chrome-plated
- Drive: 1/2" square socket, ball catch groove
- Tip: For TX screws

Packing & Sold In: Each

Item #	(mm)	L1 (mm)	L2 (mm)	L3 (mm)	D1 (mm)
WR071513430	30	120	80	12.5	22.5
WR071513440	40			12.5	
WR071513445	45			12.5	
WR071513450	50			12.5	
WR071513455	55	140	100	-	25
WR071513460	60			100	
WR071513470	70			100	

A  
B  
C  
D  
E  
F  
G  
H  
I  
J  
K  
L  
M  
N  
O  
P  
Q  
R  
S  
T  
U  
V  
W  
X  
Y

**A SOCKETS**

**ZEBRA 1/2 Inch Socket Bits**

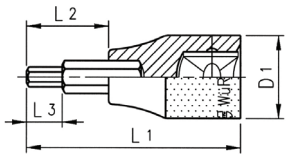

- Hexagon
- Surface: Chrome-plated, polished/matte
- Drive: 1/2" square socket, all catch groove
- DIN 7422

Packing & Sold In: Each.

Item #	(mm)	L1 (mm)	L2 (mm)	L3 (mm)	D1 (mm)	
WR0715137040	4	60	20	6	22.5	
WR0715137051	5			7.5		
WR0715137060	6			9		
WR0715137062	6	140	100	-		
WR071513707	7	60	20			10.5
WR0715137080	8					
WR0715137082	8	140	100			
WR0715137100	10	60	20			
WR0715137102	10	140	100			
WR0715137120	12	60	20			
WR0715137122	12	140	100			
WR071513714	14	60	20		25	
WR071513717	17				28	

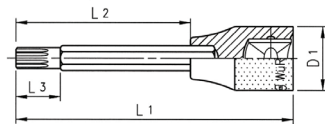
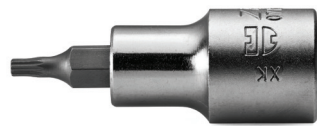

- 12-Point, Short
- Surface: Chrome-plated
- Drive: 1/2" square socket, ball catch groove

Packing & Sold In: Each



Item #	(mm)	L1 (mm)	L2 (mm)	L3 (mm)	D1 (mm)	
WR071513805	5	60	20	4	22.5	
WR071513806	6			5		
WR071513808	8			6		
WR0715138081	8	100	60			
WR071513810	10	60	20			
WR0715138101	10	100	60			
WR0715138121	12					
WR071513814	14	60	20			25
WR0715138160	16					28

**ZEBRA 1/2 Inch Hexagon Socket Bit, Short**

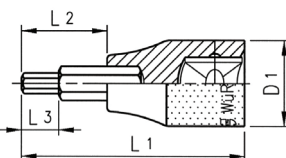

- Standard
- Surface: Chrome-plated, polished/matte
- Drive: 1/2" square socket, ball catch groove

Packing & Sold In: Each

Item #	(in.)	L1 (mm)	L2 (mm)	L3 (mm)	D1 (mm)
WR071513751	7/32	60	20	8.34	22.5
WR071513752	1/4			9.53	
WR071513754	3/8			-	
WR071513756	1/2				

## SOCKETS

### ZEBRA Step-Down/Up Sockets

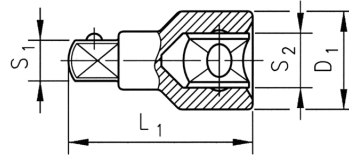

- Standard: DIN 3123, ISO 3316
  - Surface: Chrome-plated, polished
  - Material: Steel
- Packing & Sold In: Each

Item #	S2 (in)	S1 (in)	L1 (mm)	D1 (mm)
WR0713118401	1/4"	3/8"	24	12.5
WR0713128401	3/8"	1/4"	27	17
WR0713128402		1/2"	36	20
WR0712138401	1/2"	3/8"	38	23
WR0712138402		3/4"	44	25
WR071514108	3/4"	1/2"	53.5	34

### Zebra Universal Joints



- Surface: Chrome-plated, polished
  - Remains in specified position
- Packing & Sold In: Each

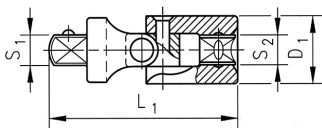

Item #	S2 (in)	S1 (in)	L1 (mm)	D1 (mm)
WR0713118301	1/4"	1/4"	33	14
WR0713128301	3/8"	3/8"	55	17.5
WR0712138301	1/2"	1/2"	70	25



A  
B  
C  
D  
E  
F  
G  
H  
I  
J  
K  
L  
M  
N  
O  
P  
Q  
R  
S  
T  
U  
V  
W  
X  
Y

**A SOCKETS**

**1/2 Inch Impact Sockets**



- Metric, short
- For use with electric or pneumatic screwdrivers and impact tools
- Standard: DIN 3129, DIN 3121/ISO 1174
- Design: Forged, burnished
- Drive: Square socket 1/2"
- Tip: Hexagon

Packing & Sold In: Each

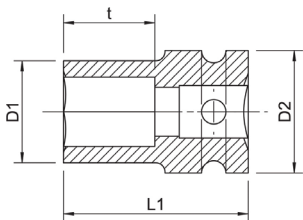

Item #	(mm)	L1 (mm)	D1 (mm)	D2 (mm)	t (mm)
WR07141302	9.5	38	17	25	12
WR07141303	10		20		10
WR07141304	12				12
WR07141305	13		21	30	13.5
WR07141306	14		22.5		12
WR07141307	15		23		13.5
WR071413071	16		25		12
WR07141308	17		26		12.5
WR071413081	18		27.3		13.5
WR07141309	19		28.5		15
WR071413091	21	30	14		
WR07141310	22	32	14.5		
WR07141311	24	34	17		
WR07141312	27	42	38	20	
WR07141330	30		42	19	
WR07141332	32	44	44	20	
WR07141334	34		46	21.5	
WR07141336	36		48	49	18.5



- Metric, long
- For use with electric or pneumatic screwdrivers and impact tools
- Standard: DIN 3129, DIN 3121/ISO 1174
- Design: Forged, burnished
- Drive: Square socket 1/2"
- Tip: Hexagon

Packing & Sold In: Each

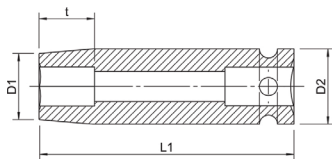

Item #	(mm)	L1 (mm)	D1 (mm)	D2 (mm)	t (mm)	
WR07141313	13	78	20.5	25	17	
WR071413131	16		24	30	23	
WR07141314	17					26
WR071413142	18		27.3			
WR07141315	19		28			
WR071413151	21		30			
WR07141316	22		32			
WR07141317	24		34			
WR07141318	27		38			30

A  
B  
C  
D  
E  
F  
G  
H  
I  
J  
K  
L  
M  
N  
O  
P  
Q  
R  
S  
T  
U  
V  
W  
X  
Y



**SOCKETS**

**1/2 Inch Impact Extensions**

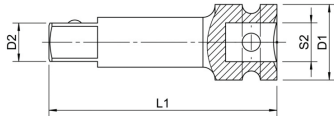

- For use with electric or pneumatic screwdrivers and impact tools
- Standard: DIN 3121/ISO 1174
- Design: Forged, burnished
- Drive: Square socket 1/2"
- Tip: External square drive 1/2", with ball lock

Packing & Sold In: Each

Item #	S2 (in)	L1 (mm)	D1 (mm)	D2 (in)
WR07141322	1/2"	75	25	1/2"
WR07141323	1/2"	150		1/2"

**Impact Step-Up Socket - 1/2 Inch to 3/4 Inch**

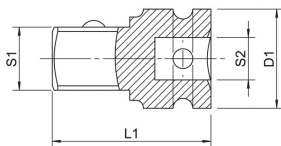

- For all electrical or compressed air-driven screwdrivers and impact tools
- Drop-forged steel guarantees high breaking and wear resistance
- Standard: DIN 3121/ISO 1174
- Design: Forged, burnished
- Drive: 1/2" square socket
- Tip: 3/4" square head

Packing & Sold In: Each

Item #	S2 (in)	S1 (in)	L1 (mm)	D1 (mm)
WR07141328	1/2"	3/4"	48	30

**1/2 Inch Impact Universal Joint**

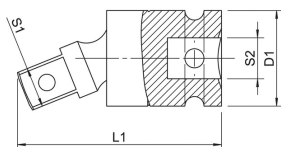

- For use with electric or pneumatic screwdrivers and impact tools
- Standard: DIN 3121/ISO 1174
- Design: Forged, burnished
- Drive: square socket 1/2"
- Tip: External square drive 1/2", with ball lock

Packing & Sold In: Each

Item #	S2 (in)	S1 (in)	L1 (mm)	D1 (mm)
WR0714138351	1/2"	1/2"	63	30

A  
B  
C  
D  
E  
F  
G  
H  
I  
J  
K  
L  
M  
N  
O  
P  
Q  
R  
S  
T  
U  
V  
W  
X  
Y

**A SOCKETS**

**ZEBRA 1/4 Inch Multi-Sockets**

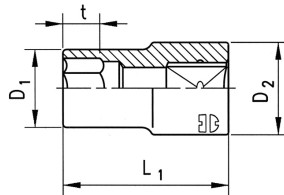

- 12-Point
  - Surface: Chrome-plated, polished
  - Drive: 1/4" square socket
  - Tip: 12-point
- Packing & Sold In: Each

Item #	Multi-profile (mm)	Possible Uses				L1 (mm)	D1 (mm)	D2 (mm)	t (mm)
		Hexagon/ Bi-hexagon (mm)	Hexagon (in.)	TX Head TX	Square (mm)				
WR071311304	4	Size 4	5/32"	E 5	-	22	6.8	11.9	5
WR071311305	5	Size 5	-	-	Size 4		8.1		
WR0713113055	5.5	Size 5.5	7/32"	-	Size 4.5		8.7		
WR071311306	6	Size 6	-	E 8	Size 5		9.3	6	
WR071311307	7	Size 7	9/32"	-	-		10.8		
WR071311308	8	Size 8	5/16"	E 10	-		11.9	7	
WR071311309	9	Size 9	11/32"	-	-		13.4		13.4
WR071311310	10	Size 10	3/8"	E 12	Size 8		14.5	14.5	10
WR071311311	11	Size 11	7/16"	E 14	Size 9		15.9	15.9	
WR071311312	12	Size 12	15/32"	E 16	Size 10		16.9	16.9	11
WR071311313	13	Size 13	1/2"	-	-		18.0	18.0	
WR071311314	14	Size 14	9/16"	E 18	-		19.6	19.6	

**SOCKETS**

**ZEBRA 1/4 Inch Multi-Socket Assortment (32 Pieces)**



Item # **WR096511032** 32 piece set

The multiple profile is suitable for the five most common screw heads (hexagon metric, square metric, bi-hex metric, hexagon inch, TX head)

- Supplied in a metal box with high-quality foam insert compartment with clamping effect
- 12 sockets
- 14 1/4" bits

Packing & Sold In: Each

**Includes:**

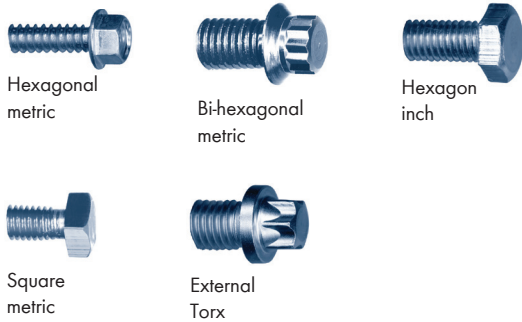

Item #	Description	Drive	Length
WR0713118301	Universal Joint	☐	33 mm
WR0613430311	Screwdriver handle		216 mm
WR07151101	Adapter with quick change chuck	⊕	30 mm
WR071311304 Thru WR071311314	12 multi-use sockets, one each sizes 4-14	⊗	22 mm
WR0614176461	Bit PH 2	⊕	25 mm
WR061417693	Bit hex, socket size 3	⊙	
WR061417694	Bit hex, socket size 4		
WR061417696	Bit hex, socket size 6		
WR06143110	TX 10	★	Sold in multiple of 5 each 25 mm
Only available in set	TX 15		
WR06143120	TX 20		
WR06143125	TX 25		
WR06143127	TX 27		
WR06143130	TX 30		
WR06143140	TX 40		



A  
B  
C  
D  
E  
F  
G  
H  
I  
J  
K  
L  
M  
N  
O  
P  
Q  
R  
S  
T  
U  
V  
W  
X  
Y

**A SOCKETS**

**ZEBRA 1/4 Inch Multi-Sockets**

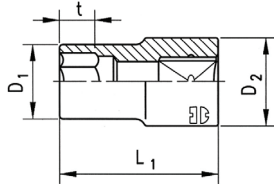

- 12-Point
  - Surface: chrome-plated, polished
  - Drive: 3/8" square socket
  - Tip: 12-Point
- Packing & Sold In: Each

Item #	Multi-profile (mm)	Possible Uses				L1 (mm)	D1 (mm)	D2 (mm)	t (mm)
		6-sd./12-sd. (mm)	6-sided (in.)	Outer TX TX	4-sided (mm)				
WR071312306	6	6 mm	-	E8	5 mm	25.5	9.3	17	7
WR0713123063	6.3	6.3 mm	1/4"	-			9.9		
WR071312307	7	7 mm	9/32"				10.9		
WR071312308	8	8 mm	5/16"	E10			11.8		8
WR071312309	9	9 mm	11/32"	-			13.4		
WR071312310	10	10 mm	3/8"	E12	8 mm		14.6		
WR071312311	11	11 mm	7/16"	E14	9 mm		15.9		
WR071312312	12	12 mm	15/32"	E16	10 mm		17		8.5
WR071312313	13	13 mm	1/2"	-			18.4		
WR071312314	14	14 mm	9/16"	E18			19.6		18
WR071312315	15	15 mm	19/32"	-	12 mm	20.9	19		
WR071312316	16	16 mm	5/8"	E20	13 mm	22	20		
WR071312317	17	17 mm	-	-	14 mm	23.4	21		
WR071312318	18	18 mm		E22		24.5	21.5		
WR071312319	19	19 mm	3/4"	E24		25.6	22.5		
WR071312320	20	20 mm	25/32"	-	16 mm	26.8	23.5	14	
WR071312321	21	21 mm	13/16"	E26	17 mm	27.9	24.5		
WR071312322	22	22 mm	7/8"	E28	18 mm	29.6	26		

**ZEBRA 3/8 Inch Multi-Socket Assortment (22 Pieces)**



Item # WR096512022 22 piece set

**Newly developed multi-purpose profile fitting the 5 most common screw heads**

- Hexagon metric, square metric, bi-hexagon metric, hexagon inch and external Torx
- Geometry: Short
- Supplied in a metal box with high-quality foam insert compartment
- High-quality multi-use socket bits guarantee a long service life
- Chrome-plated and polished
- Bit: 12-sided, multi-profile



Hexagonal metric    Bi-hexagonal metric    Hexagon inch    Square metric    External Torx



**SOCKETS**

**ZEBRA Step-Up And Step-Down Socket Assortment (8 Pieces)**



Item # WR09651280 8 piece set

**Combined adapter assortment with most common socket wrench and bit adapters**

**Socket Wrench Adapters** (1 each)  
 3/4" - 1/2", 1/2" - 3/4", 1/2" - 3/8",  
 3/8" - 1/4", 1/4" - 3/8", 3/8" - 1/2"

**Bit Adapters**  
 1/4" - 1/4", 3/8" - 5/16"

**ZEBRA 1/2 Inch Torx, Multi-Point, and Allen Socket Assortment (31 Pieces)**



Item # WR096513310 31 piece set

**Complete 1/2" assortment with short and long Allen, inner TX and multi-point sockets. Contents especially matched to automotive and cargo applications**

- Metal box 350 x 260 x 55 mm (13-3/4" x 10-1/4" x 2-3/16")
- 8 TX socket wrenches, short version TX 25, 27, 30, 40, 45, 50, 55, 60
- 4 TX socket wrenches, long version TX 30, 40, 50, 60
- 4 Multi-point socket wrenches, short version M 5, 6, 8, 10
- 3 Multi-point socket wrenches, long version M 8, 10, 12
- 8 Allen socket wrenches, short version 5, 6, 7, 8, 10, 12, 14, 17 mm
- 4 Allen socket wrenches, long version 6, 8, 10, 12 mm



A  
B  
C  
D  
E  
F  
G  
H  
I  
J  
K  
L  
M  
N  
O  
P  
Q  
R  
S  
T  
U  
V  
W  
X  
Y



**A SOCKETS**

**ZEBRA 1/2 Inch Multi-Sockets**

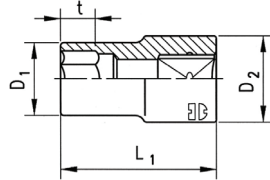

- 12-Point, Multi-profile for the five most common screw head drives
  - Surface: Chrome-plated, polished
  - Drive: 1/2" square socket
  - Tip: 12-point, multi-profile
- Packing & Sold In: Each

Item #	Multi-profile (mm)	Possible Uses				L1 (mm)	D1 (mm)	D2 (mm)	t (mm)	
		6-pt./12-pt. (mm)	6-pt. (in.)	Outer TX TX	4-pt. (mm)					
WR071213410	10	10	3/8"	E 12	8	36	15.5	23.0	9	
WR071213411	11	11	7/16"	E 14	9		16.7		10	
WR071213412	12	12	15/32"	E 16	10		18.0		11	
WR071213413	13	13	1/2"	-	-		19.2		13	
WR071213414	14	14	9/16"	E 18	-		20.5			
WR071213415	15	15	19/32"	-	12		21.7			
WR071213416	16	16	5/8"	E 20	13		23.0			
WR071213417	17	17	-	-	14		24.2		23.2	14
WR071213418	18	18	-	E 22	-		25.5		23.5	
WR071213419	19	19	3/4"	E 24	-		26.7		24.7	
WR071213420	20	20	25/32"	-	16	28.0	25.5	16		
WR071213421	21	21	13/16"	E 26	17	29.2	26.0			
WR071213422	22	22	7/8"	E 28	18	38	30.5	26.5	18	
WR071213424	24	24	15/16"	E 30	19		33.0	29.0		
WR071213426	26	26	-	E 32	21		35.5	31.5		
WR071213427	27	27	1 1/16"	E 34	22	44	36.7	32.2	20	
WR071213428	28	28	1 1/8"	E 36	23		38.0	33.5		
WR071213430	30	30	1 3/16"	E 38	24		40.5	36.0	22	
WR071213432	32	32	1 1/4"	E 40	26		43.0	38.1	24	

**ZEBRA 1/2 Inch Standard Hexagon Socket Assortment (21 Pieces)**



Item # WR09651321 21 piece set

- 1 ratchet
- 1 125mm extension
- 1 250mm extension
- 1 universal joint
- 17 Socket Wrench Inserts Sizes
- 3/8", 7/16", 1/2", 9/16", 19/32", 5/8", 11/16", 3/4", 25/32", 13/16", 7/8", 15/16", 1-1/16", 1-1/8", 1-3/16", 1-1/4"

**SOCKETS**

**ZEBRA 1/2 Inch Multi-Socket Assortment (23 Pieces)**



**Item # WR096513023 23 piece set**

- Supplied in a metal box and a high-quality foam insert to hold each piece in place
- Box: 405 x 160 x 50 mm (approx.: 16" x 6-5/16" x 2")



Designation	Tip	Length	Item #
19 multi-sockets, 1 ea., 10-32 mm		36 - 44 mm	See table below for details

Item #	Designation	Tip	Length
WR07120120	Ratchet		250 mm
WR0712138105	Extension Bar		125 mm
WR0712138110	Extension Bar		250 mm
WR0712138301	Universal Joint		70 mm

**1/2" Universal Joint**

Standard: DIN 3123, ISO 3316  
 Finish: Chrome-plated  
 Input drive: 1/2", ball groove  
 Output drive: 1/2"  
 Joint: Spring-loaded,  
 stays in set position

**1/2" Extension Bars**

Standard: DIN 3123, ISO 3316  
 Finish: chrome-plated  
 Input drive: 1/2" ball groove  
 Output drive: 1/2"

**1/2" High-Performance Ratchet**

- Easy handling and maximum service life
- Drive: 12.5mm / 1/2"
- Standard, DIN 3122, ISO 3315
- Head: Fine-toothed, 72 teeth, 5° rotating angle
- Chrome-plated with anti-slip 2-component handle resistant to general workplace oils and cleaners
- Top quality, tested by German TÜV SÜD product service
- Handy directional switch for easy switching, even with oily fingers; can be operated with one hand
- Chamfer on square enables easier pull-off as better gripping is possible
- Offset ratchet body enables more clearance for gripping with screw connections

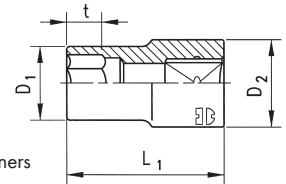

**MULTI-PROFILE**

Suitable for the five most common screw head drives:

- Hexagon** metric
- Square** metric
- Bi-hexagon** metric
- Hexagon** standard
- TX** head

Includes:	Multi-profile	Possible uses					Note: This is a metric set. Standard sizes are only approximate equivalencies and may not work in all applications!				
		6/12 sided/12		6 sided		Outside Torx	4 Sided	L1	D1	D2	t
Item #								in mm	in mm	in mm	in mm
WR071213410	10	10	1/4"	3/8"	E12	8 mm	36	15.5	23	13	9
WR071213411	11	11	1/4"	7/16"	E14	9 mm		16.7			10
WR071213412	12	12	-	15/32"	E16	10 mm		18			11
WR071213413	13	13	5/16"	1/2"	-	-		19.2			11
WR071213414	14	14	3/8"	9/16"	E18	-		20.5			13
WR071213415	15	15	-	19/32"	-	12 mm		21.7			13
WR071213416	16	16	7/16"	5/8"	E20	13 mm		23			13
WR071213417	17	17	-	-	-	14 mm		24.2			23.2
WR071213418	18	18	-	-	E22	-		25.5			23.5
WR071213419	19	19	1/2"	"	E24	-		26.7			24.7
WR071213420	20	20	-	25/32"	-	16 mm	28	25.5	16		
WR071213421	21	21	9/16"	13/16"	E26	17 mm	38	29.2	26	18	
WR071213422	22	22	-	7/8"	E28	18 mm		30.5	26.5		
WR071213424	24	24	5/8"	15/16"	E30	19 mm	44	33	29	20	
WR071213426	26	26	-	-	E32	21 mm		35.5	31.5		
WR071213427	27	27	-	1-1/16"	E34	22 mm		36.7	32.2		
WR071213428	28	28	3/4"	1-1/8"	E36	23 mm	44	38	33.5	22	
WR071213430	30	30	-	1-3/16"	E38	24 mm		40.5	36		
WR071213432	32	32	-	-	E40	26 mm		43	38.1		24

**A RATCHET / SOCKET ASSORTMENT**

**ZEBRA Pass-Through Reversible Ratchet Assortment (14 Pieces)**



**Item # WR07131300 14 piece set**

- Low-profile allows for access to narrow spaces
- Pass-through feature makes this set ideal for fastening hardware to long bolts and threaded rods
- Included socket adapters (1/4" & 3/8") can be used with any standard wrench
- Includes high-quality metal box for storage and transportation

**Sockets**

Bit: Hexagon, metric, POWERDRIV®  
Model: Chrome-plated, polished

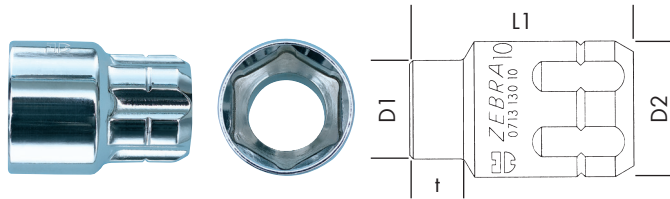

**Includes:**

Item #		L1 mm	t mm	D1 mm	D2 mm
	in mm				
WR071313010	10	32	7	14.7	19.5
WR071313011	11			15.4	
WR071313012	12			16.6	
WR071313013	13			8.5	
WR071313014	14		9.5	18.9	
WR071313015	15		11.5	20.1	
WR071313016	16		12	21.2	
WR071313017	17		22.4		
WR071313018	18		23.6		
WR071313019	19		24.8		

Item #	Designation	Length in mm
WR071313001	Ratchet	205
WR071313002	Extension	76
WR071313003	Adapter 1/4"	26
WR071313004	Adapter 3/8"	30
See table below for details	10 sockets, 10-19 mm	32

**Ratchet**

Head: 72 teeth, 5° rotating angle, round, compact head, one-hand operation with reversing lever for clockwise and counter-clockwise operation  
Model: Chrome-plated, polished, very slim design

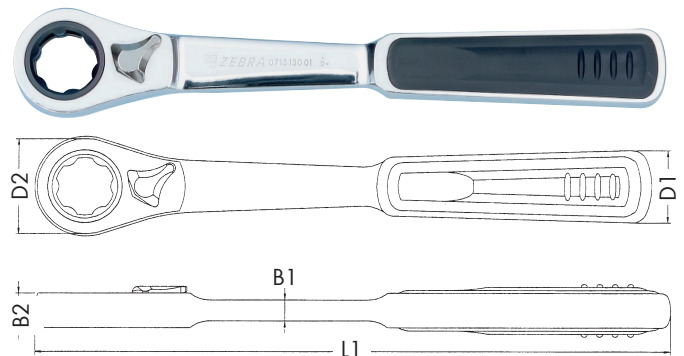

Item #	L1 mm	B1 mm	B2 mm	D1 mm	D2 mm
WR071313001	205	7	11.5	24.7	32.5

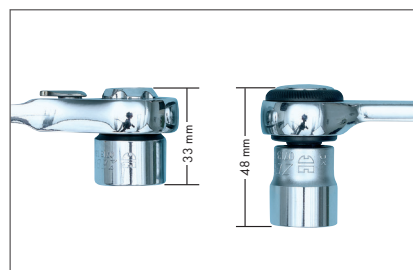

Low height of the through-ratchet as compared to the standard ratchet

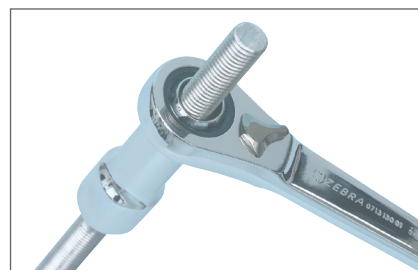

Thanks to the through-hole, long bolts and threaded rods can be processed



Through-ratchet with adapter ejector enables an easy removal of the socket spanner



**RATCHET / SOCKET ASSORTMENT**

**ZEBRA 1/4 Inch Socket Wrench Assortment**



Item # **WR0965900001** 33 piece set

**33 pcs, with drive tool**

**Contents:**

- Hexagon socket wrench inserts: SW 4; 5; 5.5; 6; 7; 8; 9; 10; 11; 12; 13; 14
- 100 and 150 mm extension
- Universal joint
- Adapter with quick-change chuck
- 1/4 inch Ratchet
- ZEBRA handle
- 3 bits: PH1; PH2; PH3
- 1 bit slotted 0.8 x 5.5mm
- 7 bits TX: TX10; 15; 20; 25; 27; 30; 40mm
- 4 hexagon bits, sizes 3, 4, 5, 6
- Foam insert

**ZEBRA 1/2 Inch Socket Wrench Assortment**



Item # **WR0965900201** 17 piece set

**17 Pieces**

- Inner TX  
TX 20, TX 25, TX 27, TX 30, TX 40,  
TX 45, TX 50, TX 55, TX 60.
- Outer TX  
E 10, E 11, E 12, E 14, E 16, E 18,  
E 20, E 24
- Foam insert

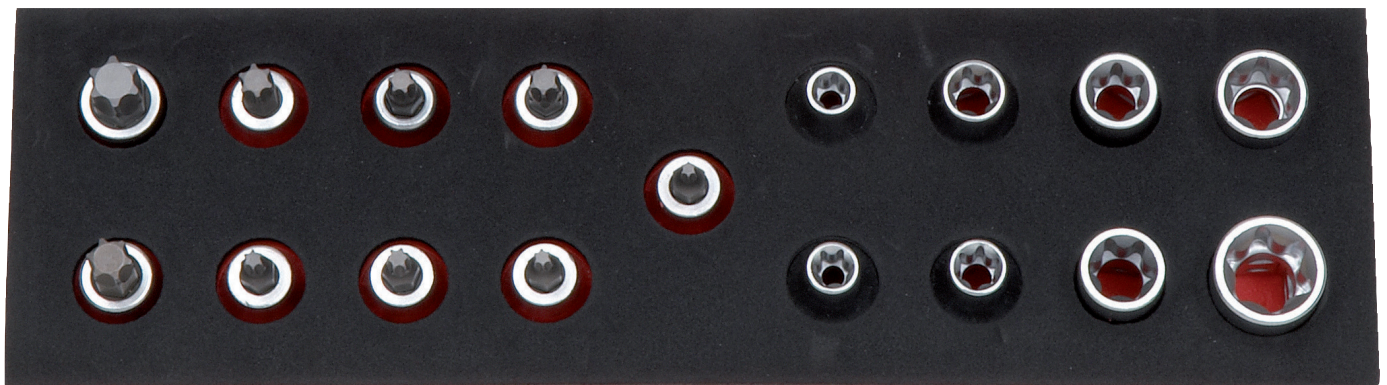

A  
B  
C  
D  
E  
F  
G  
H  
I  
J  
K  
L  
M  
N  
O  
P  
Q  
R  
S  
T  
U  
V  
W  
X  
Y

**A PLIERS / CUTTERS**

**ZEBRA Combination Pliers**



- 2K grip for gripping, holding and cutting hard and soft wires and cables
  - DIN ISO 5746
  - High-quality steel construction ensures long tool life and precision of gripping and cutting surfaces
  - Extra-long blade also suitable for thicker cables
  - Ergonomic and slip-free 2K comfort handle with narrow collar profile for comfortable working and optimum force transfer
  - Inductively hardened precision blades
  - Burner hole for gripping round materials
  - Surface: Entirely ground and chrome-plated
  - Joint: Lap joint
- Packing & Sold In: Each

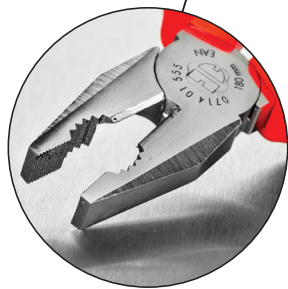

**THE HANDLE IS CRITICAL**

Optimal power distribution – Comfortable grip without pressure points thanks to special handle geometry



Slim collar shape - for optimal accessibility in tight work areas

Item #	Length (in.)	Length (mm)	Medium-hard wire	Hard wire	Copper and aluminum cable	
WR071401554	6 - 1/2"	170	3.1 mm diameter	2.0 mm diameter	10.0 mm diameter	16 mm <sup>2</sup>
WR071401555	7"	180	3.4 mm diameter	2.2 mm diameter	12.0 mm diameter	
WR071401556	8"	200	3.8 mm diameter	2.5 mm diameter	13.0 mm diameter	





**PLIERS / CUTTERS**

**ZEBRA Wire Stripping Pliers**



- 2K grip, precise, effortless stripping of cables and wires with plastic or rubber insulation
- High-quality steel construction
- Long service life and precision of cutting surfaces
- For single, multi and fine-wire conductors
- Opening spring opens pliers automatically
- Ergonomic and non-slip 2K comfort handle with narrow collar profile
- Comfortable working and optimum power transmission
- Adjustment screw can be fixed in place with knurled nut
- Surface: Entirely ground and chrome-plated
- Joint: Lap joint

Item #	Length (in)	Length (mm)	Diameter (mm)	(mm) <sup>2</sup>
WR071401550	6-1/4"	160	5	10

Packing & Sold In: Each

**ZEBRA Water Pump Pliers**



- 2K grip, self-locking water pump pliers with push-button adjustment
- DIN ISO 8976
- Rapid and convenient fine adjustment at the push of a button
- Hardened precision teeth
- High wear resistance and secure grip
- Ergonomic and non-slip 2K comfort handle with narrow collar profile
- Comfortable working and optimum power transmission
- Huge gripping capacity with slim design

Item #	Length (in)	Length (mm)	Min./Max. Grip Range
WR071401563	10"	250	16 - 46 mm

Packing & Sold In: Each



**With  
PUSH BUTTON ADJUSTMENT  
and hardened precision teeth**

A  
B  
C  
D  
E  
F  
G  
H  
I  
J  
K  
L  
M  
N  
O  
P  
Q  
R  
S  
T  
U  
V  
W  
X  
Y

**A PLIERS / CUTTERS**

**ZEBRA Needle Nose Pliers**



- 2K grip for gripping, holding and cutting soft and hard wires and cables
  - DIN ISO 5745
  - High-quality steel construction ensures long tool life and precision of gripping and cutting surfaces
  - Elastic tips for high stresses, especially under bending forces
  - Ergonomic and slip-free 2K comfort handle with narrow collar profile for comfortable working and optimum force transfer
  - Blades: Additional inductive hardening
  - Surface: Entirely ground and chrome-plated
  - Gripping surfaces: Toothed
  - Joint: Lap joint
- Packing & Sold In: Each

Item #	Length (in)	Length (mm)	Tip Geometry	Jaw shape	L3 (mm)	W3 (mm)	T1 (mm)	W4 (mm)	T2 (mm)
WR071401557	8-1/4"	210			76	17.5	9.5	4	3
WR071401558				40°	72				
WR071401559	6-1/4"	160			50	16.5	9	3	2.5
WR071401562				40°	46				

**ZEBRA Side Cutters**



Milled precision cutting edge saves strength and gives a clean cut!

- 2K grip for cutting hard and soft wires and cables, including in hard-to-reach places
  - DIN ISO 5749
  - High-quality tool steel ensures long service life and precision of blades
  - Slim head shape for optimum accessibility
  - Ergonomic and slip-free 2K comfort handle with narrow collar profile for comfortable working and optimum force transfer
  - Inductively hardened precision blades
  - Surface entirely ground and chrome-plated
  - Lap joint
- Packing & Sold In: Each

Item #	Length (in.)	Length (mm)	Soft wire	Medium-hard wire	Hard wire
WR071401566	5 - 1/2"	140	4.0 mm diameter	2.5 mm diameter	1.8 mm diameter
WR071401567	6 - 1/4"	160		2.8 mm diameter	2.0 mm diameter
WR071401568	7"	180		3.0 mm diameter	2.5 mm diameter

**PLIERS / CUTTERS**

**ZEBRA Power Side Cutters**



- 2K grip for cutting piano wire, hard and soft wire
- DIN ISO 5749
- Strength-saving. Milled precision cutting edge for clean cuts
- High-quality steel ensures long service life and precision of blades
- Ergonomic and slip-free 2K comfort grip handle with narrow collar profile for comfortable working and optimum force transfer
- Inductively hardened precision blades
- Surface: Ground and chrome-plated
- Joint: Lap joint, forged-on rivets

Packing & Sold In: Each

Item #	Length (in.)	Length (mm)	Soft wire	Medium-hard wire	Hard wire	Piano wire
WR071401551	5 - 1/2"	140	4.0 mm diameter	3.1 mm diameter	2.0 mm diameter	1.5 mm diameter
WR071401552	6 - 1/4"	160		3.4 mm diameter	2.5 mm diameter	2.0 mm diameter
WR071401553	7"	180		3.8 mm diameter	2.7 mm diameter	2.2 mm diameter
WR071401598	8"	200	4.5 mm diameter	4.2 mm diameter	3.0 mm diameter	2.5 mm diameter

**ZEBRA Heavy-Duty Side Cutters, Reversible**



By pressing the power button, you get twice the cutting power!

- 2 tools in one: Side cutters with connectible lever transmission
- High cutting power cuts thick cables
- Avoids hard cutting impact found with conventional side cutters
- Precision cutting ensures a long service life
- Manufactured from high-grade steel
- Safe handling
- Ergonomic 2K plastic handle with non-slip surface
- Surface: Chrome-plated
- Joint: Launched

Packing & Sold In: Each

**2 in 1!**

Side cutters with connectible lever transmission

Item #	Length (in.)	Length (mm)	Soft wire	Medium-hard wire	Hard wire	Piano wire
WR071401599	8"	200	5 mm diameter	4.5 mm diameter	3.5 mm diameter	3 mm diameter

A  
B  
C  
D  
E  
F  
G  
H  
I  
J  
K  
L  
M  
N  
O  
P  
Q  
R  
S  
T  
U  
V  
W  
X  
Y



**A PLIERS / CUTTERS**

**ZEBRA Pliers and Cutters Sets**



**Item # WR071401560 4 piece set**

- 2K grip, set of one of each combination pliers, wire stripping pliers, needle nose pliers, and power side cutters
- High-quality steel construction ensures long service life and precision of gripping and cutting surfaces
- Combination pliers with extra-long blade also suitable for thicker cables
- Wire stripping pliers with opening spring for automatic opening
- Needle nose pliers with tips for high bending stresses
- Heavy-duty side cutters for piano wire, hard and soft wire
- Ergonomic and slip-free 2K comfort handle with narrow collar profile for comfortable working and optimum force transfer

**Includes:**

Item #	Contents	Length (in)	Length (mm)
WR071401555	Zebra Combination Pliers	7"	180
WR071401550	Zebra Wire Stripping Pliers	6-1/4"	160
WR071401557	Zebra Needle Nose Pliers	8-1/4"	210
WR071401552	Zebra Power Side Cutters	6-1/4"	160



**Item # WR071401565 4 piece set**

- 2K grip, set of one of each combination pliers, water pump pliers, needle nose pliers, and power side cutters
- High-quality steel construction ensures long service life and precision of gripping and cutting surfaces
- Combination pliers with extra-long blade also suitable for thicker cables
- Water pump pliers with convenient quick adjustment
- Needle nose pliers with tips for high bending stresses
- Heavy-duty side cutters for piano wire, hard and soft wire
- Ergonomic and slip-free 2K comfort handle with narrow collar profile for comfortable working and optimum force transfer

**Includes:**

Item #	Contents	Length (in)	Length (mm)
WR071401555	Zebra Combination Pliers	7"	180
WR071401563	Zebra Water Pump Pliers	10"	250
WR071401557	Zebra Needle Nose Pliers	8-1/4"	210
WR071401552	Zebra Power Side Cutters	6-1/4"	160



**PLIERS / CUTTERS**

**ZEBRA Pliers Assortment**



Item # WR0965900600 4 piece set

- 2K Grip
- 4 piece set of 2K grip pliers
- Foam drawer insert and cutters

Includes:

Item #	Contents	Length (in)	Length (mm)
WR071401555	Zebra Combination Pliers	7"	180
WR071401563	Zebra Water Pump Pliers	10"	250
WR071401557	Zebra Needle Nose Pliers	8-1/4"	210
WR071401552	Zebra Power Side Cutters	6-1/4"	160



Side cutters:  
160 mm

Combination pliers:  
180 mm



Water pump pliers:  
250 mm

Needle nose pliers:  
210 mm

**THE HANDLE IS CRITICAL**

Optimal power distribution – Comfortable grip without pressure points thanks to special handle geometry



A  
B  
C  
D  
E  
F  
G  
H  
I  
J  
K  
L  
M  
N  
O  
P  
Q  
R  
S  
T  
U  
V  
W  
X  
Y



**A PLIERS / CUTTERS**

**Circlip Pliers Form A/B**



A

- For shaft locking rings
- Standard: DIN 5254
- Handle: Plastic-coated
- Guarantees a secure grip, prevents slippage
- Compressed Spring Steel Tip
- Optimized stability for use with tight fitting and seized rings
- Inserted Tips
- Offers maximum strength when loosening tight-fitting/seized rings and allows rings to be installed with minimal distortion
- Screwed and Mounted Joint

- High precision and optimized movement
- Large Contact Surfaces
- Rings mounted with minimal torsion
- Pliers Head
- Slim design for optimum access to work piece, especially in hard-to-reach areas
- Internal Spring
- Lies protected in the internal joint

Packing & Sold In: Each



B

Item #	Length (mm)		Min./Max. grip range	Tenon diameter (mm)	Jaws length (mm)	Hook length (mm)
WR07140211	140	A Straight	3 - 10	0.9	39	-
WR07140212			10 - 25	1.25	38	
WR07140213	180		19 - 60	1.8	56	
WR07140214	225		40 - 100	2.25	70	
WR07140215	320	B 90°	85 - 140	3.2	92	12
WR07140216	130		3 - 10	0.9	27	
WR07140217			10 - 25	1.25		
WR07140218	165		19 - 60	1.8	40	
WR07140219	210		40 - 100	2.25	55	
WR07140220	305		85 - 140	3.2	73	

**Circlip Pliers Form C/D**



C

- For retaining rings (bore circlips)
- Standard: DIN 5256
- Handle: Plastic-coated
- Guarantees a secure grip, slip-resistant
- Compressed Spring Steel Tip
- Optimized stability for use with tight-fitting and seized rings
- Inserted Tips
- Offers maximum strength when loosening tight-fitting/seized rings and allows rings to be installed with minimal distortion

- Screwed and Mounted Joint
- High precision and optimized movement
- Large Contact Surfaces
- Rings mounted with minimal torsion
- Pliers Head
- Slim design for optimum access to work piece, especially in hard-to-reach areas

Packing & Sold In: Each



D

Item #	Length (mm)		Min./Max. grip range	Tenon diameter (mm)	Jaws length (mm)	Hook length (mm)
WR07140201	140	C Straight	8 - 13	0.9	39	-
WR07140202			12 - 25	1.25	38	
WR07140203	180		19 - 60	1.8	54	
WR07140204	225		40 - 100	2.25	65	
WR07140205	320	D 90°	85 - 140	3.2	91	12
WR07140206	130		8 - 13	0.9	26	
WR07140207			12 - 25	1.25		
WR07140208	165		19 - 60	1.8	40	
WR07140209	210		40 - 100	2.25	49	
WR07140210	305		85 - 140	3.2	73	

**PLIERS / CUTTERS**

**Circlip Plier Set (4 Pieces)**

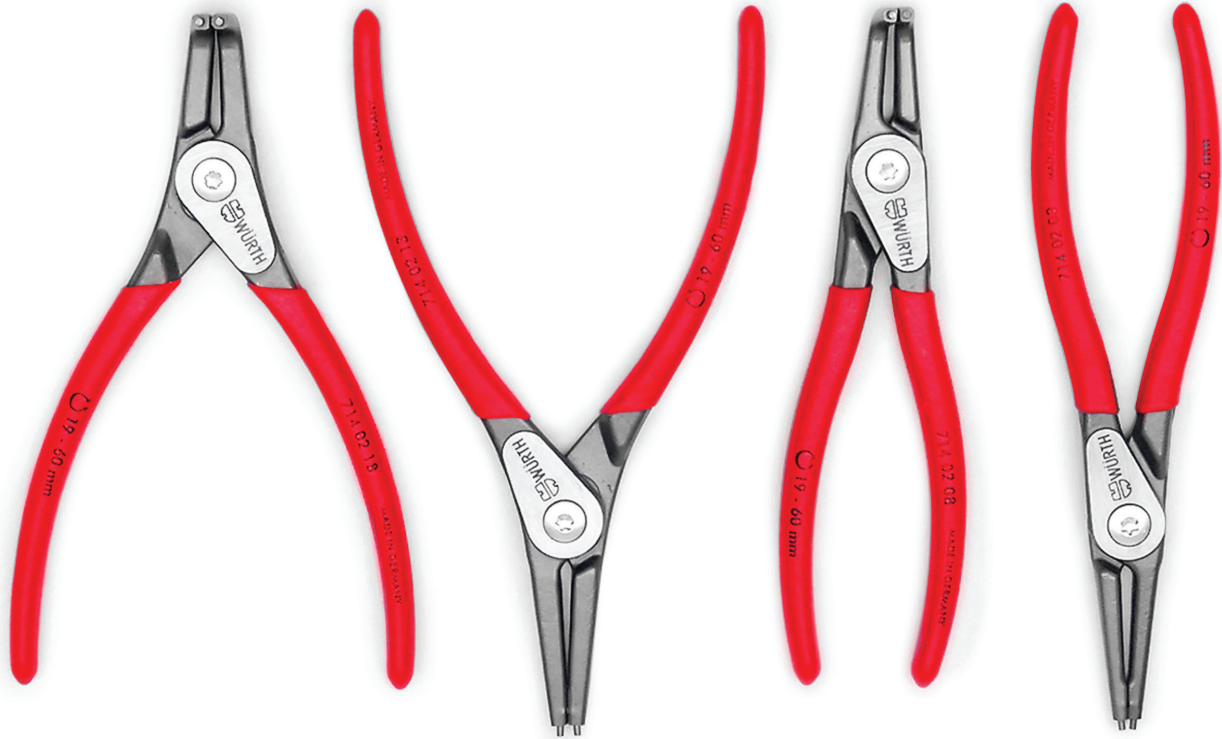

**Item # WW07140230 4 piece set**

- 4-piece set
- Handle: Plastic-coated
- Guarantees a secure grip, prevents slippage
- Tip from compressed spring steel
- Optimized stability, even with seized rings
- Inserted tips
- Offers maximum strength when loosening seized rings and allows rings to be installed with minimal distortion
- Screwed and mounted joint
- High precision and optimized movement
- Large locating faces
- Rings mounted without torsion
- Pliers head
- Narrow design for optimum access to workpiece, including in hard-to-reach spots
- Contents:
  - Form A Circlip Pliers, 19 - 60 mm grip range
  - Form B Circlip Pliers, 19 - 60 mm grip range
  - Form C Circlip Pliers, 19 - 60 mm grip range
  - Form D Circlip Pliers, 19 - 60 mm grip range

**Includes:**

Item #	Form / Grip Range
WR07140213	Form A, 19 - 60 mm
WR07140218	Form B, 19 - 60 mm
WR07140203	Form C, 19 - 60 mm
WR07140208	Form D, 19 - 60 mm

**A PLIERS / CUTTERS**

**Zebra Vice-Grip Locking Pliers**



**Features:**

- Effortless release lever with spring mechanism
- One-hand operation – pull-action rather than push-action
- Lock nut for fixing clamping width, setting retained for repetitive applications
- Ergonomic design
- Comfortable and effortless handling
- High-quality epoxy coating, welding beads roll off
- 10x better rust resistance than Nickel coatings

Packing & Sold In: Each

**Straight Jaws**



Item #	Length (mm)	Clamping Width (mm)
WR07150909	190	0-42
WR07150910	235	0-63

**Long Straight Jaws**



Item #	Length (mm)	Clamping Width (mm)
WR07150904	235	0-70

**Semi-Circular Jaws**



Item #	Length (mm)	Clamping Width (mm)
WR07150906	135	0-30
WR07150907	190	0-42
WR07150908	235	0-63



**SNIPS**

**Zebra Sheet Metal Snips - Short Length**



**Maneuverable, powerful and compact**



- Double Leverage
- Lower application of force with simultaneously increased cutting performance
- No slipping and no serration
- Perfect Design
- Small and lightweight
- Easily stores in most pockets
- Extremely Compact Shearing Head
- Ideal for cutting extremely tight radii and for hard-to-reach places
- Combined lock and stop for improved safety
- Cutting snips can be quickly and easily closed and kept closed
- Ergonomically shaped handle
- Easy to grip
- Allows for lower fatigue

Packing & Sold In: Each

Item #	Version	Length (mm)	Cutting capacity (mm)	
			Steel	Stainless Steel
WR071303200	Right-hand cutting	180	1.2	0.8



A  
B  
C  
D  
E  
F  
G  
H  
I  
J  
K  
L  
M  
N  
O  
P  
Q  
R  
S  
T  
U  
V  
W  
X  
Y

**A SNIPS**

**Zebra Sheet Metal Snips**



**Leverage Sheet Metal Cutting Snips For Continuous And Shaped Cuts**

- Rounded grip made from 2-component plastic
- Prevents hands from slipping
- Lower handle made from 1-component plastic
- Simply slide your finger over the lower handle when opening and closing the handle
- Handle heights prevent the cutting snips from slipping out of your hand
- Allows for safe execution
- Long service life
- Cutting head manufactured from stainless steel, die-forged
- Induction hardened cutting edges
- Non-serrated cutting geometry
- Helps prevent sheet metal slipping
- Lever transmission
- High cutting power with less effort

Packing & Sold In: Each



**Ideal Snips for continuous and figure cutting**

Item #	Version	Length (mm)	Cutting capacity (mm)	
			Steel	Stainless Steel
WR071303100	Right-hand cutting	260	1.8	1.2
WR071303110	Left-hand cutting			



- Longer service life
- Especially suitable for cutting stainless steel

**Ideal Carbide Snips with carbide cutting edges for continuous and figure cutting**

Item #	Version	Length (mm)	Cutting capacity (mm)	
			Steel	Stainless Steel
WR071303130	Right-hand cutting	260	1.8	1.2
WR071303135	Left-hand cutting			



**Figure Snips for continuous and tight figure cutting**

Item #	Version	Length (mm)	Cutting capacity (mm)	
			Steel	Stainless Steel
WR071303115	Right-hand cutting	260	1.8	1.2
WR071303120	Left-hand cutting			





