



WÜRTH

WÜRTH LOUIS AND COMPANY

TRESCO[®]

CATALOG



tresco 
lighting

TABLE OF CONTENTS

4-5

Neoloop



15-18

Infinex



6-7

**White
Tunable
FlexTape®**



19-20

FlexTape®



8-9

**COB
FlexTape®**



21-22

**Equiline
Tape**



10-11

**RGB
Tunable
FlexTape®**

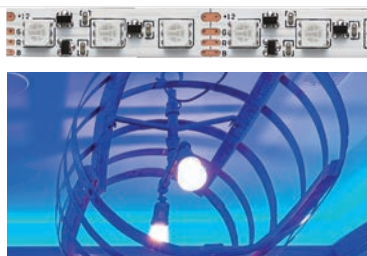

23

Eurolinx

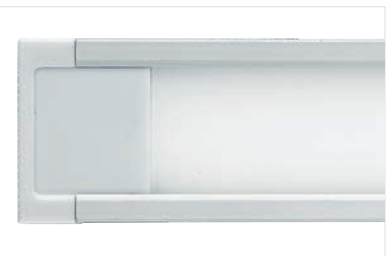

12

**4W CCT
Power
Pockit®**



24

**FineLine
2.0**

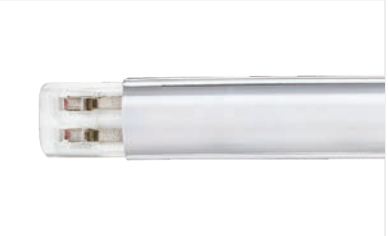

12-14

**RGB-CCT
Accessories**



25

**3W Power
Pockit®**



TABLE OF CONTENTS

26

**3W EquiLine
Puck**



37-40

**FREEDiM
Wireless
Controllers**



27-29

**Plug-In
Power
Supplies**



41

**Round
Controllers**



30-31

**Hardwire
Power
Supplies**



42

**Dimmer
Switches**



32-35

Swidget



43

**On/Off Switches
& Extension
Cords**



36

**Wall
Dimmer
Switches**

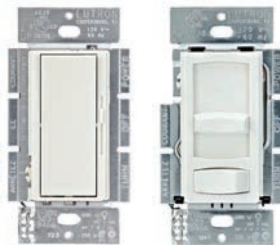

TRESCO® NEOLOOP

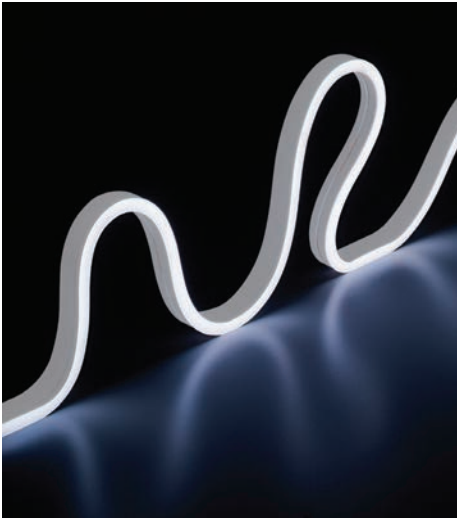

Neoloop Flexible Silicone LED Lighting Side-Emitting, 12 Volt

- 3 Watts per foot, 100 lumens per foot, 110° beam spread
- Flexible silicone construction
- Flat illuminated side emitting, bendable on the horizontal axis, IP65 rated
- Sold in 16.4' rolls and cuttable every 1"
- Linkable with connectors
- 79" starter cords are molded on each end for easy installation
- Presses into a 6mm W x 12mm D groove for recess mounting
- Size: 1/2"H x 1/4"W
- IP65 rated for use in indoor, outdoor*, damp and wet* locations,
*when used with factory installed inputs



Item #	Quick Code	Description	Light Color
RVN1-12V3WM-30K5M	T936	12V 3W/FT, 16.4' Roll	3000K
RVN1-12V3WM-35K5M	T937	12V 3W/FT, 16.4' Roll	3500K
RVN1-12V3WM-48K5M	T938	12V 3W/FT, 16.4' Roll	4800K



Neoloop Side-Emitting Starter Cord (Optional)

- Used to connect the Neoloop light to the power supply mounting block

Item #	Quick Code	Description
RVN12PKT-2M	T954	79"L Starter Cord



Neoloop Side-Emitting Linking Cords (Optional)

- Used to connect two Neoloop lights together

Item #	Quick Code	Description
RVN1-LNK25	T956	10"L Linking Cord
RVN1-LNK60	T957	24"L Linking Cord
RVN1-LNK120	T958	48"L Linking Cord
RVN1-LNK180	T959	72"L Linking Cord

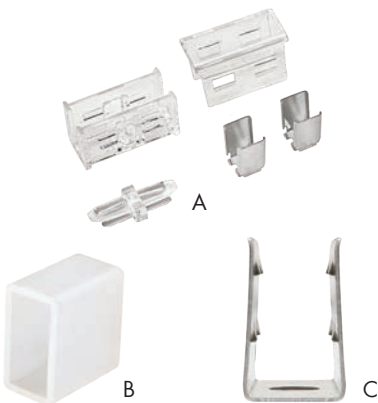

Neoloop Side-Emitting Back-To-Back Connector & End Cap & U-Clips (Optional)

- Accessories for Neoloop Side-Emitting LED lights

	Item #	Quick Code	Description
A	RVN1-BTB	T964	Connector used to connect two lights back-to-back
B	RVN1-ENDCAP	T950	End Cap used to cap the end of a light
C	RVN1-UCLP	T952	U-Clips, 10 per pack

NOTE: Power Supplies on pages 27-31 and accessories on pages 32-43.

TRESCO® NEOLOOP



Neoloop Flexible Silicone LED Lighting Top-Emitting, 12 Volt

- 3 Watts per foot, 200 lumens per foot, 145° beam spread
- Flexible silicone construction
- Curved illuminated top emitting, bendable on the vertical axis, IP65 rated
- Sold in 16.4' rolls and cuttable every 1"
- Linkable with connectors
- 79" starter cords are molded on each end for easy installation
- Size: 7/16"H x 13/32"W
- IP65 rated for use in indoor, outdoor*, damp and wet* locations, *when used with factory installed inputs



Item #	Quick Code	Description	Light Color
RVN2-12V3WM-30K5M	T931	12V 3W/FT, 16.4' Roll	3000K
RVN2-12V3WM-35K5M	T932	12V 3W/FT, 16.4' Roll	3500K
RVN2-12V3WM-48K5M	T933	12V 3W/FT, 16.4' Roll	4800K

Neoloop Top-Emitting Starter Cord (Optional)

- Used to connect the Neoloop light to the power supply mounting block



Item #	Quick Code	Description
RVN22PKT-2M	T955	79"L Starter Cord

Neoloop Top-Emitting Linking Cords (Optional)

- Used to connect two Neoloop lights together



Item #	Quick Code	Description
RVN2-LNK25	T960	10"L Linking Cord
RVN2-LNK60	T961	24"L Linking Cord
RVN2-LNK120	T962	48"L Linking Cord
RVN2-LNK180	T963	72"L Linking Cord

Neoloop Top-Emitting Back-To-Back Connector & End Cap & U-Clips (Optional)

- Accessories for Neoloop Top-Emitting LED lights

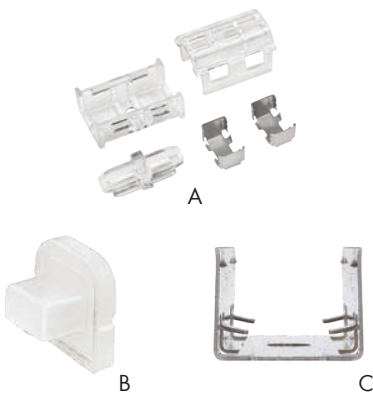

	Item #	Quick Code	Description
A	RVN2-BTB	T965	Connector used to connect two lights back-to-back
B	RVN2-ENDCAP	T951	End Cap used to cap the end of a light
C	RVN2-UCLP	T953	U-Clips, 10 per pack

NOTE: Power Supplies on pages 27-31 and accessories on pages 32-43.

TRESCO® WHITE TUNABLE FLEXTAPE®



2700K

Changing your light source's color temperature is easy with TreSCO® Lighting's White Tunable CCT FlexTape®. Select between a warmer temperature that highlights natural wood grains and earth tones or cool to highlight whites. Eliminate the guesswork and get the LED that pairs perfectly with your general lighting and overall design.



3500K



6500K

Features:

- 115-degree beam spread excellent for illuminating cabinets, displays, store fixtures and more
- High output at 345 lumens per ft.
- Cuttable and linkable with simple FlexConnect connectors and DIY accessories allowing customization for your project
- Precision tuning from Warm (2700K) to Cool (6500K) with parent controller/receiver (sold separately)
- Dimmable with optional tunable wireless remote or wall dimmer (sold separately)
- Low-profile 300 LSE adhesive 3M™ backing allows versatility to install in a multitude of places
- 5-year commercial-grade warranty



3W/ft.
(9.8W/m)



Dimensions:

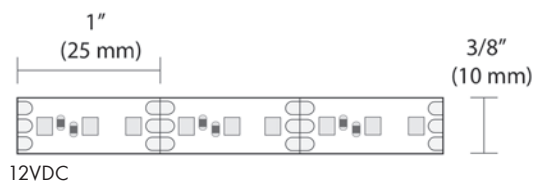
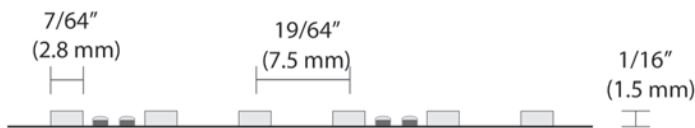

12VDC



12VDC

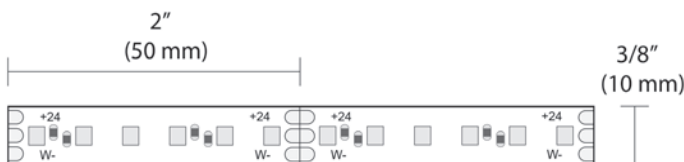

24VDC



24VDC

TRESCO® WHITE TUNABLE FLEXTAPE®

Typical Setup:

12VDC

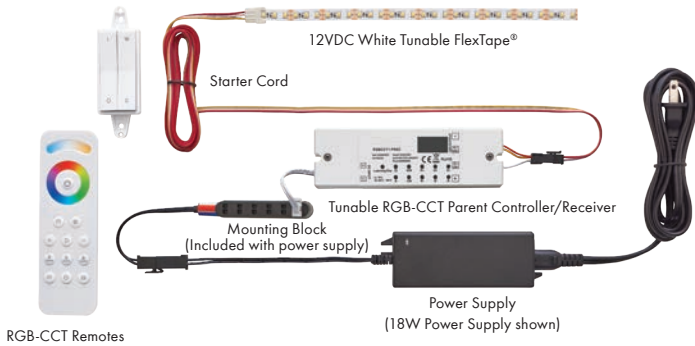

24VDC

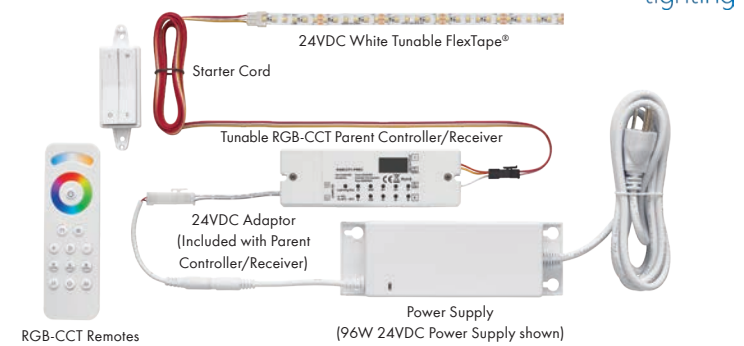

NOTE: Power Supplies on pages 27-31 and accessories on pages 32-43.

White Tunable (CCT) FlexTape® and Required Components

12/24VDC White Tunable FlexTape®



Item #	Quick Code	Description
RVFLXTPE12CCT	T667	12V, 16.4' Roll, 3W/FT
RVFLXTPE-24CCT	T669	24V, 16.4' Roll, 3W/FT

12/24VDC CCT Starter Cord



Item #	Quick Code	Description
RVTPEPKT2IN-CCT	T711	2"L
RVTPEPKT2M-CCT	T701	79"L

12/24VDC RGB-CCT Parent Controller/Receiver

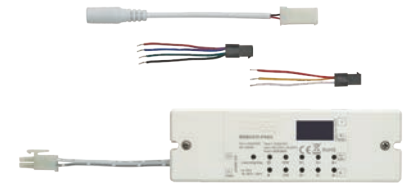

Item #	Quick Code	Description
RVRGBCCT1-PREC	T673	Parent Receiver

White Tunable (CCT) FlexTape® Optional Components

12/24VDC Starter CCT Extension Leads



Item #	Quick Code	Desc.
RVCCTEXT-60	T659	24"L
RVCCTEXT20	T658	48"L

12/24VDC RGB-CCT Child Controller/Receiver



Item #	Quick Code	Description
RVRGBCCT1-CREC	T672	Child Receiver

12/24VDC CCT Link Cords

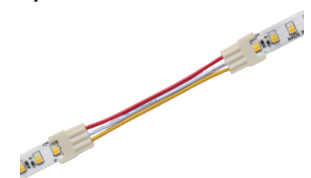

12/24VDC CCT Back-to-Back Connector



Item #	Quick Code
RVTPELNK-BTB	T479

12/24VDC RGB-CCT Remotes



Item #	Quick Code	Description
RVRGBCCT-RMT	T674	Wireless Remote
RVWLDCCT-WH	T703	Deco Wall Dimmer, White

12/24VDC CCT DIY Wire and Terminal Block



Item #	Quick Code	Desc.
RVCCTWIRE25	T660	25' 20AWG CCT Wire Roll
RVBS4PBL	T657	Barrier Splice 4 Position

12/24VDC 6 Output Adaptor



Item #	Quick Code
RV4P6O	T656

Wire and terminal block can be used as a DIY option to create longer extensions.

Connects to the parent or child controller/receiver to control multiple lights

NOTE: All product dimensions and specifications are subject to change without prior notice.

TRESCO® COB FLEXTAPE®



Chip on Board or “COB” FlexTape® is the latest advancement in tape lighting. With diodes directly mounted on a printed circuit board and a continuous fortified coating, this flexible, high density LED lighting strip creates our Luniform look without dark spots – no covers or filters needed!

Features:

- New generation of tape lighting with encapsulated diodes to protect from splashes, dust and moisture
- 115° beam angle excellent for illuminating store fixtures, backlighting, edge lighting and more
- Cutable and linkable with our standard FlexTape® link cords, tee connector and 90-degree connector
- Available in 2700K, 3000K, 3500K, 4800K or 6500K
- Low-profile 300 LSE adhesive 3M™ backing allows versatility to install in a multitude of places
- Dimmable with optional controllers (sold separately)
- 5-year commercial-grade warranty

12VDC



4.4W/ft.
(14.5W/m)

245 Lumens
per ft.
(809 per meter)



24VDC



5.5W/ft.
(18.1W/m)

420 Lumens
per ft.
(1386 per meter)



Strong 300 LSE 3M™ adhesive backing

Dimensions:

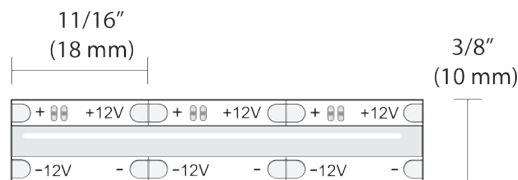

12VDC

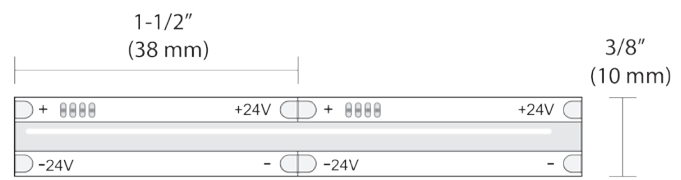

24VDC

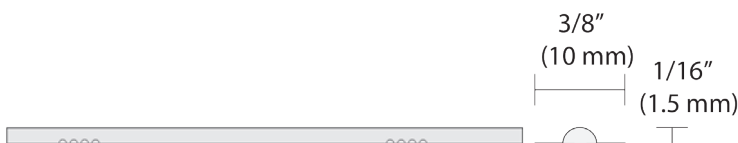

TRESCO® COB FLEXTAPE®

Typical Setup:

12VDC

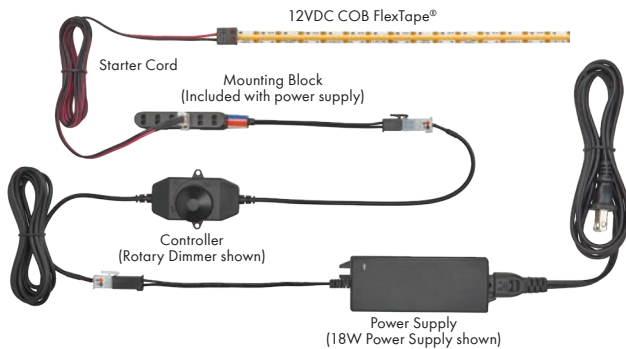

24VDC

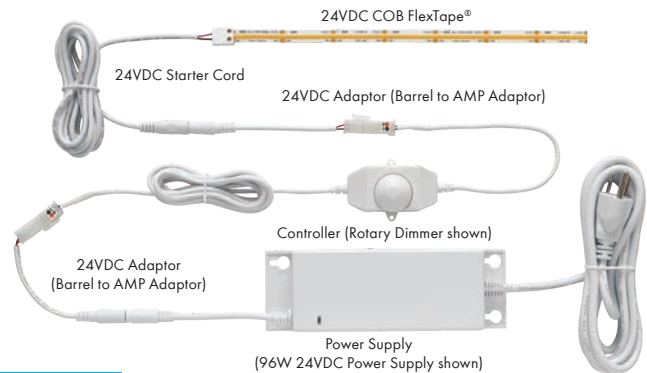

NOTE: Power Supplies on pages 27-31 and accessories on pages 32-43.

12VDC COB FlexTape® and Required Starter Cord Options

12VDC COB FlexTape® 4.4W



Item #	Quick Code	Description
RVFLXCOB12-27RV	T661	12V, 13' Roll, 2700K, 4.4W/FT
RVFLXCOB12-30RV	T662	12V, 13' Roll, 3000K, 4.4W/FT
RVFLXCOB12-35RV	T716	12V, 13' Roll, 3500K, 4.4W/FT
RVFLXCOB12-48RV	T663	12V, 13' Roll, 4800K, 4.4W/FT
RVFLXCOB12-65RV	T717	12V, 13' Roll, 6500K, 4.4W/FT

12VDC Starter Cord for Single Color Tape



Item #	Quick Code	Description
RVLED-TPEPKT-2M	T147	79" Starter Cord
RVTPPKT2IN-CCT	T711	2" Starter Cord

12VDC Tee Starter Cord for Single Color Tape



Item #	Quick Code	Desc.
RVLED-TPEPKT-2MTEE	T180	79" Tee Starter Cord

12VDC Extension Lead (Optional)



Item #	Quick Code	Desc.
RVLED-LINKD-8	T351	3" L
RVLED-LINKD-15	T844	6" L
RVLED-LINKD-25	T194	10" L
RVLED-LINKD-60	T195	24" L
RVLED-LINKD-120	T203	48" L
RVLED-LINKD-180	T190	72" L
RVLEDLINKD-245	T447	96" L

COB FlexTape® and Required Starter Cord Options

24VDC COB FlexTape® 5.5W



Item #	Quick Code	Description
RVFLXCOB24-27RU	T664	24V, 16.4' Roll, 2700K, 5.5W/FT
RVFLXCOB24-30RU	T665	24V, 16.4' Roll, 3000K, 5.5W/FT
RVFLXCOB24-35RU	T714	24V, 16.4' Roll, 3500K, 5.5W/FT
RVFLXCOB24-48RU	T666	24V, 16.4' Roll, 4800K, 5.5W/FT
RVFLXCOB24-65RU	T715	24V, 16.4' Roll, 6500K, 5.5W/FT

24VDC Starter Cord for COB



Item #	Quick Code	Description
RV24B2SPKT-2M	T648	79" Starter Cord

24VDC Tee Starter Cord for COB



Item #	Quick Code	Desc.
RV24B2SPKT2M-TEE1	T649	79" Tee Starter Cord

24VDC Extension Lead (Optional)



Item #	Quick Code	Description
RV24BBEXTM	T650	39" Barrel Extension Cord
RV24BBEXT-2M	T651	79" Barrel Extension Cord
RV24BBEXT-3M	T652	119" Barrel Extension Cord

12VDC – 24VDC COB FlexTape® Optional Components

12/24VDC Link Cord for Single Color Tape



Item #	Quick Code	Desc.
RVLED-TPELNK-5	T144	2" L
RVLED-TPELNK-15	T141	6" L
RVLED-TPELNK-25	T143	10" L
RVLED-TPELNK-60	T145	24" L
RVLED-TPELNK-120	T140	48" L
RVLED-TPELNK-180	T142	72" L

12/24VDC Tee Connector for Single Color Tape



Item #	Quick Code
RVLED-TPELNK-TEE	T146

12/24VDC Right Angle Connector for Single Color Tape



Item #	Quick Code
RVLEDTPELNK-CON90	T152

12/24VDC Back-to-Back Connector for COB



Item #	Quick Code
RVTPELNK-BTB	T479

NOTE: All product dimensions and specifications are subject to change without prior notice.

TRESCO® RGB TUNABLE FLEXTAPE®



STANDARD

Creating dramatic lighting with 16 million color combinations is now a reality with RGB Standard color-changing FlexTape®. Created and priced for everyday projects.

BALANCE

RGB Balance FlexTape® goes the distance with the addition of On-Board Constant Current Regulators. By mitigating voltage drop, the On-Board Constant Current Regulators ensure a balanced color from start to finish. Created for high-end projects including residential, hospitality and commercial.

Features:

- 120-degree beam spread excellent for illuminating cabinets, displays, store fixtures and more
- Cuttable and linkable with simple FlexConnect connectors and DIY accessories allowing customization for your project
- Precision tuning of R, G and B with parent controller/receiver (sold separately)
- Dimmable with optional tunable wireless remote or wall dimmer (sold separately)
- Low-profile 300 LSE adhesive 3M™ backing allows versatility to install in a multitude of places
- 5-year commercial-grade warranty



4.4W/ft.
(14.4W/m)



DIMENSIONS:

12VDC Balance



24VDC Balance

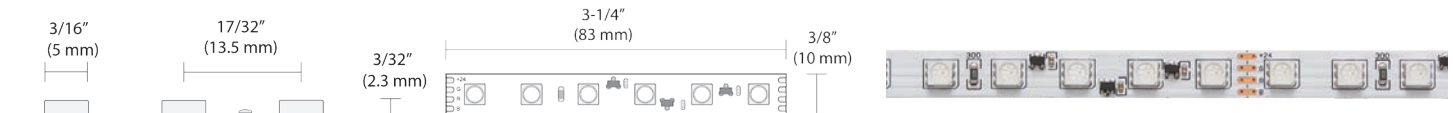

24VDC Standard



TRESCO® RGB TUNABLE COB FLEXTAPE® cont'd

12VDC

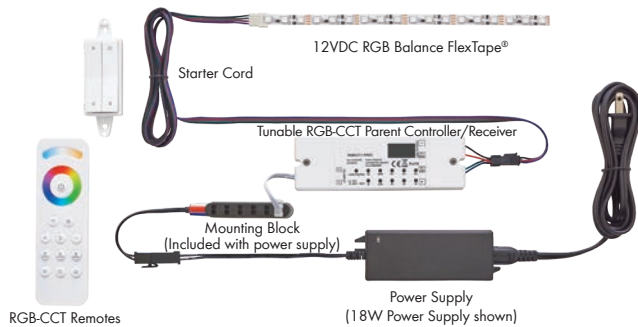

24VDC

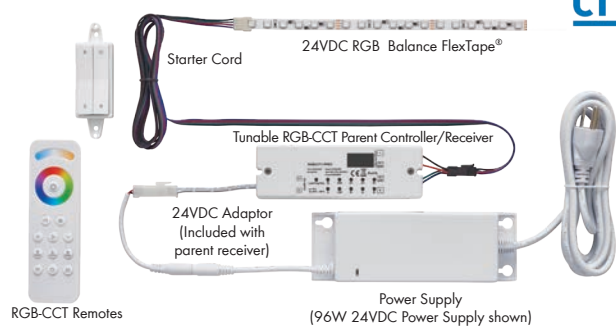

NOTE: Power Supplies on pages 27-31 and accessories on pages 32-43.

RGB Tunable FlexTape® and Required Components

12/24VDC RGB Balance Tunable FlexTape®



Item #	Quick Code	Description
RVFLXTPE2RGB	T668	12V, 13' Roll, 4.4W/FT
RVFLXTPE-24RGB	T712	24V, 16.4' Roll, 4.4W/FT

24VDC RGB Standard FlexTape®



Item #	Quick Code	Description
RVTPELED-24RGB	T686	24V, 16.4' Roll, 4.4W/FT

12/24VDC RGB Starter Cord



Item #	Quick Code	Description
RVTPEPKT2IN-RGB	T713	2" L Starter Cord
RVTPEPKT2M-RGB	T702	79" L Starter Cord

12/24VDC RGB-CCT Parent Controller/Receiver



Item #	Quick Code	Description
RVRGBCCT1-PREC	T673	Parent Receiver

RGB Tunable FlexTape® Optional Components

12/24VDC Starter RGB Extension Leads



Item #	Quick Code	Desc.
RVRGBEXT-60	T676	24" L
RVRGBEXT20	T675	48" L

12/24VDC RGB-CCT Child Controller/Receiver



Item #	Quick Code	Desc.
RVRGBCCT1-CREC	T672	Child Receiver

12/24VDC RGB Link Cords

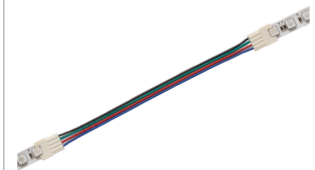

Item #	Quick Code	Desc.
RVTPELNK5-RGB	T698	2" L
RVTPELNK15-RGB	T692	6" L
RVTPELNK25-RGB	T696	10" L
RVTPELNK60-RGB	T700	24" L
RVTPELNK120-RGB	T690	48" L
RVTPELNK180-RGB	T694	72" L

12/24VDC RGB Back-to-Back Connector



Item #	Quick Code
RVTPELNK-BTB	T479

12/24VDC RGB-CCT Remotes



Item #	Quick Code	Desc.
RVRGBCCT-RMT	T674	Wireless Remote
RVWLDRGB-WH	T704	Deco Wall Dimmer, White

12/24VDC RGB DIY Wire and Terminal Block



Item #	Quick Code	Desc.
RVRGBWIRE25	T677	25' 20AWG RGB Wire Roll
RVBS4PBL	T657	Barrier Splice 4 Position

Wire and terminal block can be used as a DIY option to create longer extensions.

12/24VDC 6 Output Adaptor



Item #	Quick Code
RV4P6O	T656

Connects to the parent or child controller/receiver to control multiple lights

NOTE: All product dimensions and specifications are subject to change without prior notice.

TRESCO® 4W CCT POWER POCKET® & RGB-CCT ACCESSORIES

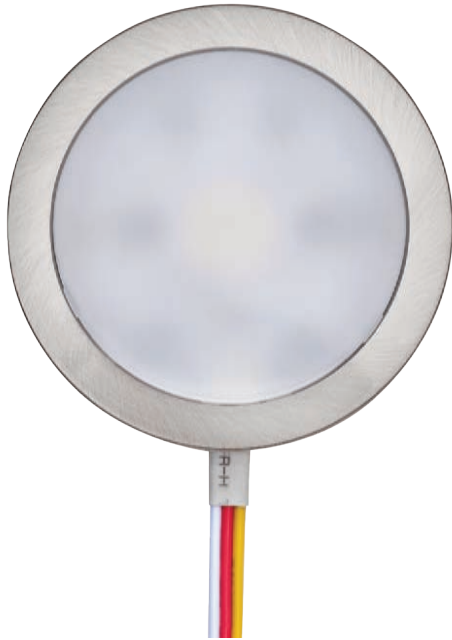

24 Volt 4W CCT Power Pocket®

- Aluminum die cast construction w/79" cord and milk lens
- 2-1/4" Bore Hole Dia x 1/2"D
- 105-degree beam spread
- Recess or surface mount
- White Tunable from 2700K-6500K (2700K = 236 lumens / 6500K = 280 lumens)

Black Item #	Quick Code	Color	Description
RVPOC-4CCT24-BL	T900	Black	24V 4W CCT Puck Light
RVPOC-4CCT24-NI	T901	Nickel	24V 4W CCT Puck Light
RVPOC-4CCT24-WH	T902	White	24V 4W CCT Puck Light

NOTE: Power Supplies on pages 27-31 and accessories on pages 32-43.



A (Parent)



B (Child)

RGB-CCT Controller/Receivers 12 VOLT / 24 VOLT

- 60W capacity (12VDC); 96W capacity (24VDC)
- Digital user interface
- Power failure memory
- Simple one-button programming of FREEDiM Series wireless controls
- Compatible Tresco® FREEDiM series RGB or CCT hand and wall controllers (sold separately)
- Works with any 12/24VDC Tresco® RGB or CCT low voltage lights
- Complete with pigtails for RGB or CCT connection
- Tuning of the RGB or Color temperature from 2700K-6500K



Display in RGB mode. RGB values can be tuned in increments of 1



Display in CCT mode. CCT values can be tuned in increments of 15-16K (Color temperature is range)

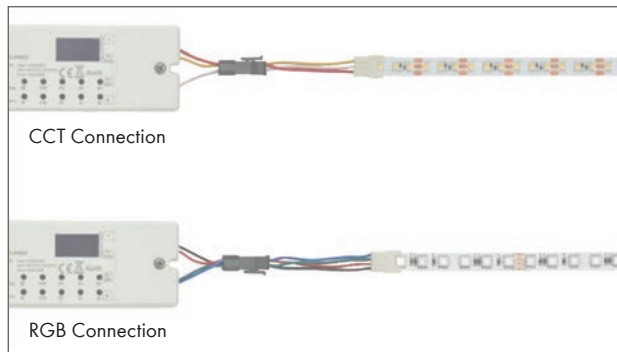

CCT Connection

RGB Connection

	Item #	Quick Code	Description	Size
A	RVRGBCCT1-PREC	T673	12VDC/24VDC RGB-CCT Parent Controller/Receiver	1-13/16"W x 5/8"H x 5-3/4"L
B	RVRGBCCT1-CREC	T672	12VDC/24VDC RGB-CCT Child Controller/Receiver	1-13/16"W x 5/8"H x 5-3/4"L

TRESCO® RGB-CCT ACCESSORIES

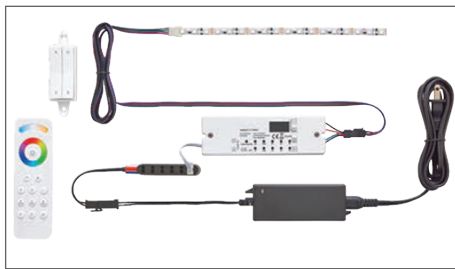

12 Volt Set Up

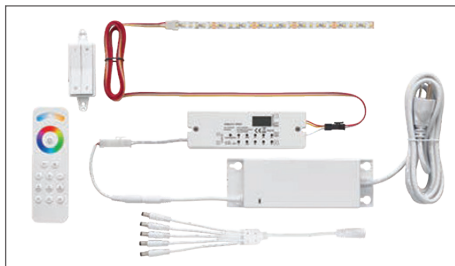

24 Volt Set Up

RGB-CCT Controllers/Receivers Set Up

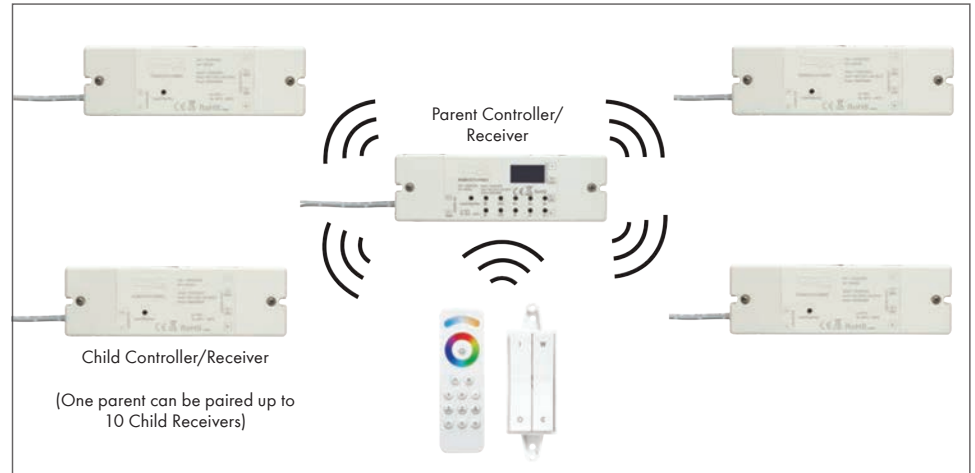

Wireless remote controls 1 parent per zone and 10 child receivers per parent



RGB-CCT Wall Controllers

- (2) configurations: RGB or CCT (White tunable)
- Can be programmed with up to (1) parent and (10) child receivers
- Fits Decora® style wall plates
- 65 ft. (20 m) range of control from dimmer to receiver
- Controls all Tresco® RGB or CCT low voltage lights
- RGB/CCT receivers required (sold separately)
- Long-lasting CR1625/1620 battery (included)

CCT – White tunable

- Easy touch warm 2700K to daylight 6500K and on/off/dimming controls

RGB

- Easy touch Red, Green, Blue and on/off/dimming controls



	Item #	Quick Code	Description
A	RVWLCCT-WH	T703	CCT FREEDiM Deco Wall Dimmer White
B	RVWLRGB-WH	T704	RGB FREEDiM Deco Wall Dimmer White

TRESCO® RGB-CCT ACCESSORIES

RGB-CCT Wireless Remote

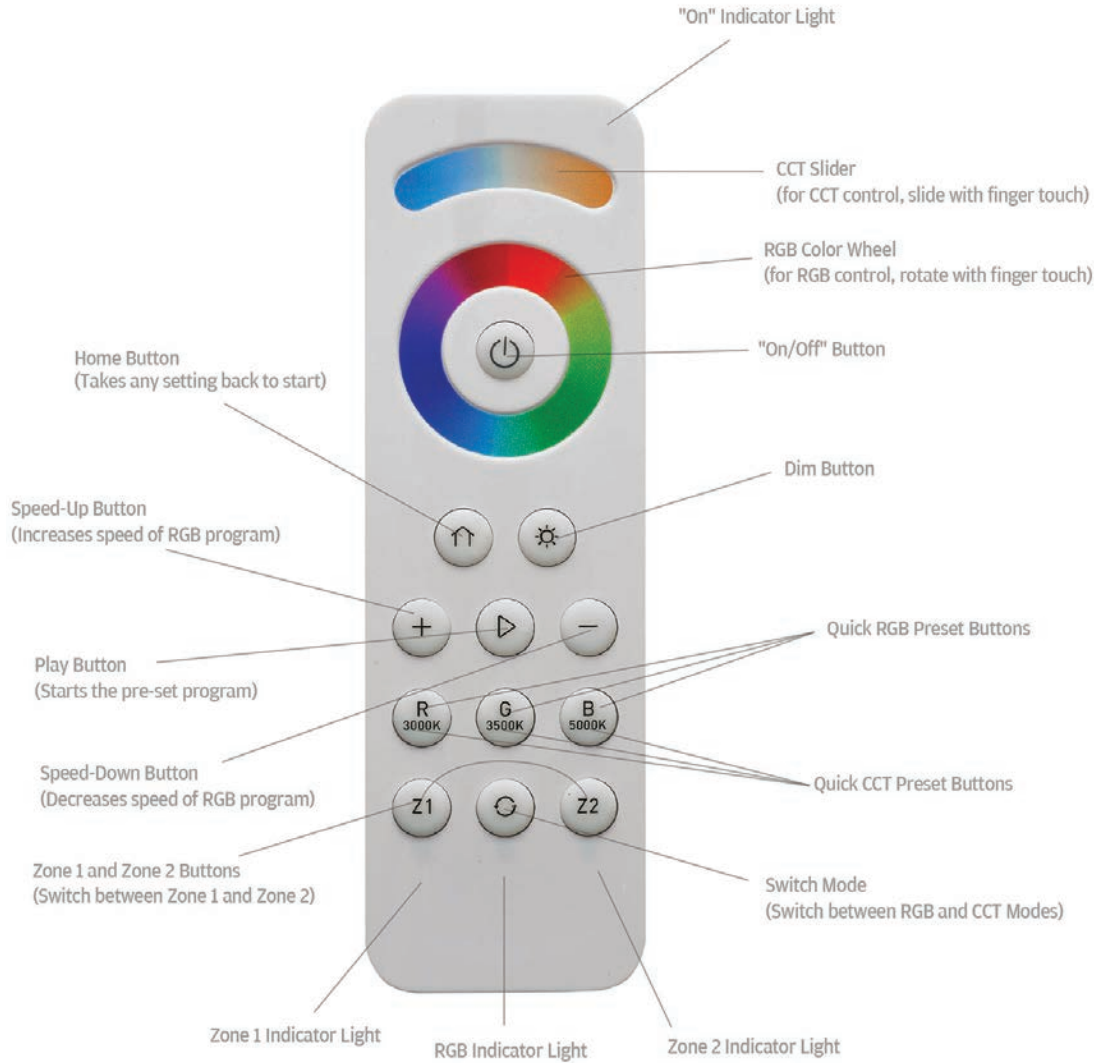

- Intuitive and ergonomic design
- Can control RGB and CCT
- Touch control for color mixing
- Quick set buttons for common CCT and static RGB values
- Program up to (2) separate zones and control independently
- (10) preset RGB sequences with speed control (i.e. fade in, fade out)
- A single remote can control 1 parent and 10 child receivers per zone



Item #	Quick Code	Description	Size
RVRGBCCT-RMT	T674	RGB-CCT Wireless Hand Remote	1-23/32"W x 5-17/32"L



- 1 CHOOSE YOUR ALUMINUM CHANNEL STYLE & FINISH**
- 2 CHOOSE YOUR DIFFUSERS**
- 3 CHOOSE YOUR LED TAPE**
- 4 CHOOSE YOUR END CAPS & STARTER CORD & LINKING CORDS**
- 5 CUT TO SIZE & ASSEMBLE**
- 6 OPTIONS**

TRESCO® INFINEX

1 CHOOSE YOUR ALUMINUM CHANNEL STYLE & FINISH



Extruded Aluminum Channel

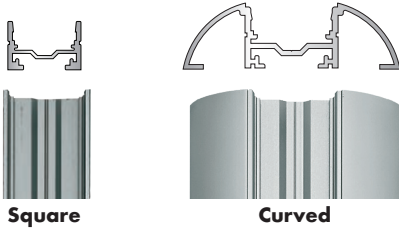

Square

Curved

Shape	Size	Clear Aluminum Item #	Quick Code	Black Item #	Quick Code
Square	72"L	RVXSQR72-SC	T394	RVXSQR72-BL	T551
Curved	72"L	RVXCRV72-SC	T405	RVXCRV72-BL	T828

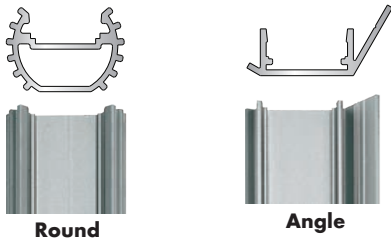

Round

Angle

Shape	Size	Clear Aluminum Item #	Quick Code	Black Item #	Quick Code
Round	72"L	RVXRND72-SC	T397	RVXRND72-BL	T829
Angle	72"L	RVXANG72-SC	T407	-	-

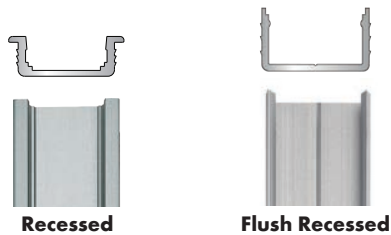

Recessed

Flush Recessed

Shape	Size	Clear Aluminum Item #	Quick Code	Black Item #	Quick Code
Recessed	72"L	RVXREC72-SC	T401	RVXREC72-BL	T582
Flush Recessed (Includes Milk Diffuser)	72"L	RVXFL72-SC-10	T546		
Flush Recessed (Includes Milk Diffuser)	96"L	RVXFL96-SC	T547		

2 CHOOSE YOUR DIFFUSERS (Required Item)

Clear Diffuser



1.5W FlexTape®

Frosted Diffuser



1.5W FlexTape®

Milk Diffuser



1.5W FlexTape®

Diffusers

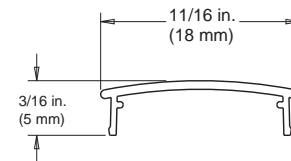

3W FlexTape®



3W FlexTape®



3W FlexTape®



4.4W FlexTape®



4.4W FlexTape®



4.4W FlexTape®

Item #	Quick Code	Description
RVX72-DIFF-CL	T409	72" (1.8 m) Diffuser Clear
RVX72-DIFF-FR	T408	72" (1.8 m) Diffuser Frosted
RVX72-DIFF-MLK	T544	72" (1.8 m) Diffuser Milk

TRESCO® INFINEX

3 CHOOSE YOUR LED TAPE

(See Tape options on pages 19-22)



4 CHOOSE YOUR END CAPS & STARTER CORD & LINKING CORDS

End Caps for Extruded Aluminum Channels

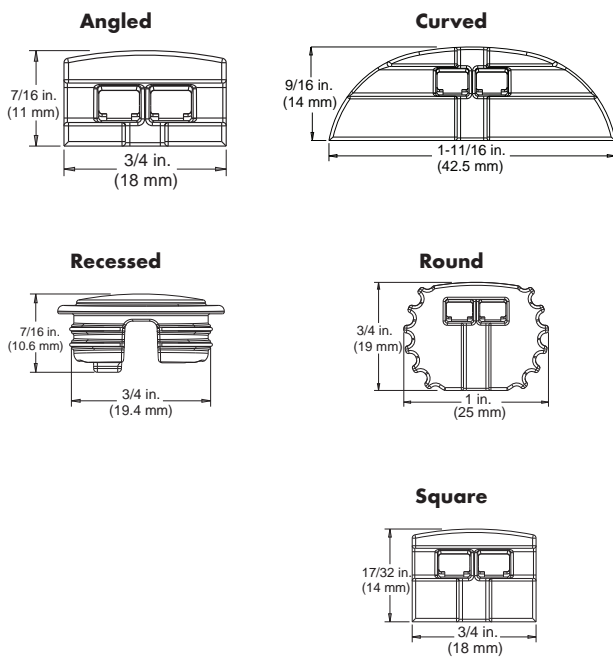

Shape	Black Finish Item #	Quick Code	Gray Finish Item #	Quick Code
Angled	-		RVXANGECP-GY	T406
Curved	RVXCRVECP-BL	T833	RVXCRVECP-GY	T404

Shape	Black Finish Item #	Quick Code	Gray Finish Item #	Quick Code
Recessed	RV-XRECECP-BL	T834	RV-XRECECP-GY	T400
Round	RV-XRNDECP-BL	T835	RV-XRNDECP-GY	T396

Shape	Black Finish Item #	Quick Code	Gray Finish Item #	Quick Code
Square	RV-XSQRECP-BL	T553	RV-XSQRECP-GY	T393

79" (2 m) Starter Cord



Black Finish Item #	Quick Code	White Finish Item #	Quick Code
RVXPKT-2M-BL	T403	RVXPKT-2M-WH	T402

Linking Cords



Black Finish Item #	Quick Code	White Finish Item #	Quick Code	Description
RVXLNK-BL	T489	RVXLNK-WH	T484	15 cm (6") Length
RVXLNK-25-BL	T490	RVXLNK-25-WH	T485	25 cm (10") Length
RVXLNK-60-BL	T491	RVXLNK-60-WH	T486	60 cm (24") Length
RVXLNK-120-BL	T492	RVXLNK-120-WH	T487	120 cm (48") Length
RVXLNK-180-BL	T493	RVXLNK-180-WH	T488	180 cm (72") Length

TRESCO® INFINEX

5 CUT TO SIZE & ASSEMBLE



Aluminum extrusions can be cut on a variety of equipment. For the best performance and longest life, use a saw blade designed for non-ferrous, thin stock, on your miter saw. It is also highly recommended to cut extrusion with diffuser securely attached via clamps, tape, stretch wrap etc. to prevent unwanted cracking of diffuser.

6 OPTIONS

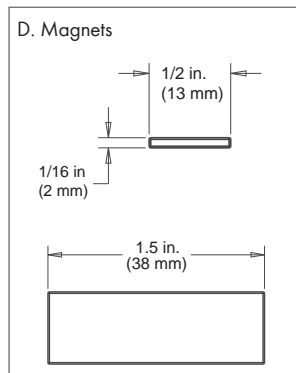
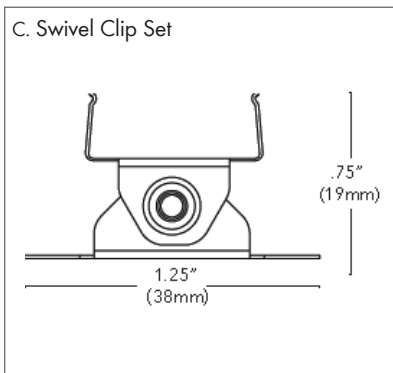
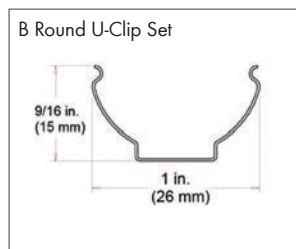
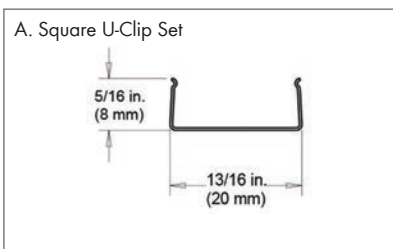

U-Clips/Magnets

	Item #	Quick Code	Description
A	RV-XSQR-UCLP	T395	Square/Curved U-Clip Set (2 Clips)
B	RV-XRND-UCLP	T398	Round U-Clip Set (2 Clips)
C	RVXSQRSWCLP	T555	Swivel Clip Set (2 Clips)
D	RV-XRM42-155	T399	Set of 2 Magnets



Back-to-Back Connectors

- Used with Square & Curved Channels Only
- 10 Per Pack

Item #	Quick Code	Description
RVEXTBTB10	T545	Back-to-Back Connectors (10 Per Pack)

TRESCO® FLEXTAPE® 1.5W



Specifications:

Lumens: 150 per ft.

Lamp Life: 50,000 Hours

Mounting: Surface

Warranty: 5 years

Beam Angle: 115°

Maximum continuous run in 20'

Maximum per power supply is 40'

Cuttable every 2"

To be used on clean, smooth surfaces

Sold by the roll



Required Items		
Item #	Quick Code	Description
RVLEDFLXTPE-WROLL	T151	1.5W Per Foot, 20' FlexTape® Roll, 2700K
RVLEDFLXTPE-NROLL	T445	1.5W Per Foot, 20' FlexTape® Roll, 3500K
RVLEDFLXTPE-CROLL	T150	1.5W Per Foot, 20' FlexTape® Roll, 4800K
RVLEDFLXTPE-DROLL	T823	1.5W Per Foot, 20' FlexTape® Roll, 6500K

FlexTape® 1.5W works with all Tresco® 12VDC power supplies.

Required Items		
Item #	Quick Code	Description
RVTPEPKT-2IN1	T824	2" 12VDC FlexTape® Straight Starter Lead
RVLED-TPEPKT-2M	T147	79" (2 m) 12VDC FlexTape® Straight Starter Lead
RVLED-TPEPKT-2MTEE	T180	79" (2 m) 12VDC FlexTape® Tee Starter Lead

Optional Items		
Item #	Quick Code	Description
RVTPELNK-BTB	T479	Back-to-Back Connector
RVLED-TPELNK-TEE	T146	Tee Link Connector
RVLEDTPELNK-CON90	T152	90° Link Connector

Item #	Quick Code	Description
RVLED-TPELNK-5	T144	2" (5 cm) 12VDC FlexTape® Link Cord
RVLED-TPELNK-15	T141	6" (15 cm) 12VDC FlexTape® Link Cord
RVLED-TPELNK-25	T143	10" (25 cm) 12VDC FlexTape® Link Cord
RVLED-TPELNK-60	T145	24" (60 cm) 12VDC FlexTape® Link Cord
RVLED-TPELNK-120	T140	48" (120 cm) 12VDC FlexTape® Link Cord
RVLED-TPELNK-180	T142	72" (180 cm) 12VDC FlexTape® Link Cord

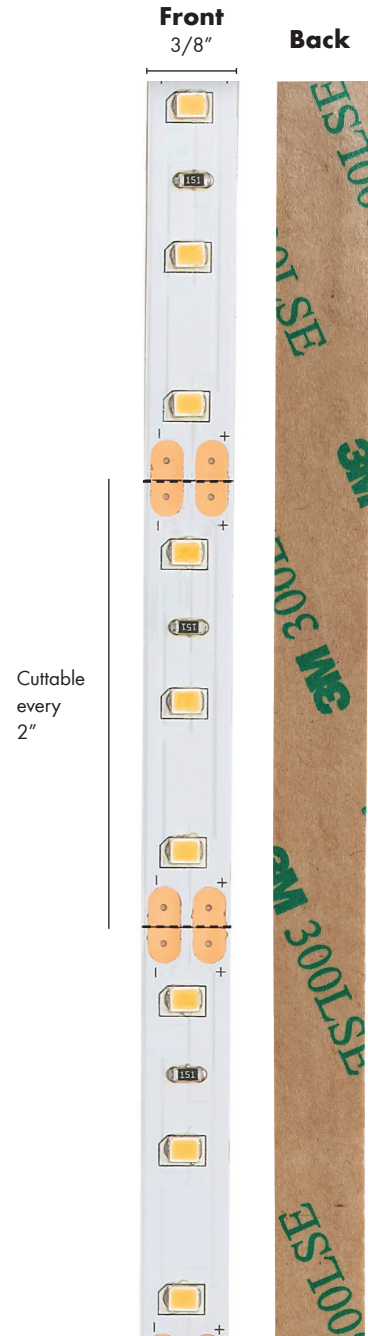

Cuttable every 2"

NOTE: Power Supplies on pages 27-31 and accessories on pages 32-43.

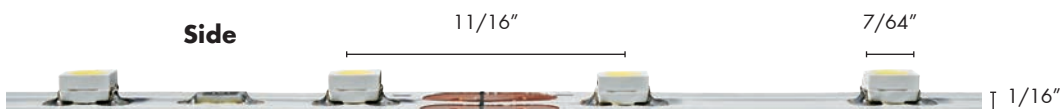

TRESCO® FLEXTAPE® 3W



Specifications:

- Lumens: 365 per ft.
- Lamp Life: 50,000 Hours
- Mounting: Surface
- Warranty: 5 years
- Beam Angle: 115°
- Maximum continuous run in 16.4'
- Maximum per power supply is 20'
- Cuttable every 1"
- To be used on clean, smooth surfaces

Sold by the roll



Required Items		
Item #	Quick Code	Description
RVLED-FLXTPE-WRHO	T318	3W Per Foot, 16.4' FlexTape® Roll, 2700K
RVLED-FLXTPE-NRHO	T444	3W Per Foot, 16.4' FlexTape® Roll, 3500K
RVLED-FLXTPE-CRHO	T319	3W Per Foot, 16.4' FlexTape® Roll, 4800K
RVLED-FLXTPE-DRHO	T825	3W Per Foot, 16.4' FlexTape® Roll, 6500K

FlexTape® 3W works with all Tresco® 12VDC power supplies.

Required Items		
Item #	Quick Code	Description
RVTPEPKT-2IN1	T824	2" 12VDC FlexTape® Straight Starter Lead
RVLED-TPEPKT-2M	T147	79" (2 m) 12VDC FlexTape® Straight Starter Lead
RVLED-TPEPKT-2MTEE	T180	79" (2 m) 12VDC FlexTape® Tee Starter Lead

Optional Items		
Item #	Quick Code	Description
RVTPELNK-BTB	T479	Back-to-Back Connector
RVLED-TPELNK-TEE	T146	Tee Link Connector
RVLEDTPELNK-CON90	T152	90° Link Connector

Item #	Quick Code	Description
RVLED-TPELNK-5	T144	2" (5 cm) 12VDC FlexTape® Link Cord
RVLED-TPELNK-15	T141	6" (15 cm) 12VDC FlexTape® Link Cord
RVLED-TPELNK-25	T143	10" (25 cm) 12VDC FlexTape® Link Cord
RVLED-TPELNK-60	T145	24" (60 cm) 12VDC FlexTape® Link Cord
RVLED-TPELNK-120	T140	48" (120 cm) 12VDC FlexTape® Link Cord
RVLED-TPELNK-180	T142	72" (180 cm) 12VDC FlexTape® Link Cord

NOTE: Power Supplies on pages 27-31 and accessories on pages 32-43.

Front

3/8"

Back

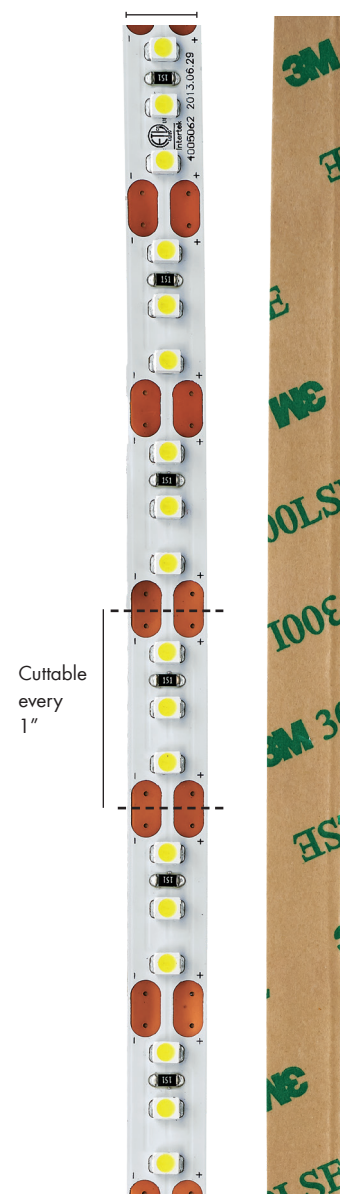

TRESCO® EQUILINE TAPE LED 1.5W



Specifications:

- Lumens: 135 per ft.
- Input Voltage: 12VDC
- Lamp Life: 25,000 Hours
- Mounting: Surface
- Warranty: 2 years
- Maximum continuous run in 20'
- Maximum per power supply is 40'
- Cutable every 2"
- To be used on clean, smooth surfaces

Sold by the roll



Required Items		
Item #	Quick Code	Description
RV-TPELED-27SER	T415	1.5W Per Foot, 20' EquiLine FlexTape® Roll, 2700K
RVTPELED-35SER	T474	1.5W Per Foot, 20' EquiLine FlexTape® Roll, 3500K
RVTPELED-48SER	T413	1.5W Per Foot, 20' EquiLine FlexTape® Roll, 4800K
RVTPELED-65SER	T843	1.5W Per Foot, 20' EquiLine FlexTape® Roll, 6500K

EquiLine Tape 1.5W works with all Treco® 12VDC power supplies.

Required Items		
Item #	Quick Code	Description
RVTPEPKT-2IN1	T824	2" 12VDC Straight Starter Lead
RVLED-TPEPKT-2M	T147	79" (2 m) 12VDC Straight Starter Lead
RVLED-TPEPKT-2MTEE	T180	79" (2 m) 12VDC Tee Starter Lead

Optional Items		
Item #	Quick Code	Description
RVTPELNK-BTB	T479	Back-to-Back Connector
RVLED-TPELNK-TEE	T146	Tee Link Connector
RVLEDTPELNK-CON90	T152	90° Link Connector

Item #	Quick Code	Description
RVLED-TPELNK-5	T144	2" (5 cm) 12VDC FlexTape® Link Cord
RVLED-TPELNK-15	T141	6" (15 cm) 12VDC FlexTape® Link Cord
RVLED-TPELNK-25	T143	10" (25 cm) 12VDC FlexTape® Link Cord
RVLED-TPELNK-60	T145	24" (60 cm) 12VDC FlexTape® Link Cord
RVLED-TPELNK-120	T140	48" (120 cm) 12VDC FlexTape® Link Cord
RVLED-TPELNK-180	T142	72" (180 cm) 12VDC FlexTape® Link Cord

NOTE: Power Supplies on pages 27-31 and accessories on pages 32-43.

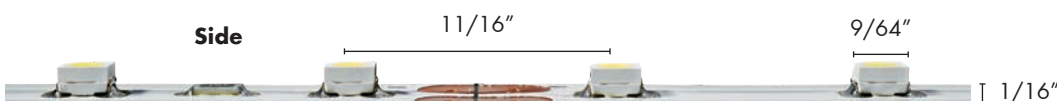

TRESCO® EQUILINE TAPE LED 3W



Specifications:

- Lumens: 255 per ft.
- Input Voltage: 12VDC
- Lamp Life: 25,000 Hours
- Mounting: Surface
- Warranty: 2 years
- Maximum continuous run in 16.4'
- Maximum per power supply is 20'
- Cuttable every 1"
- To be used on clean, smooth surfaces

Sold by the roll



Required Items		
Item #	Quick Code	Description
RVTPELED-27HER	T416	3W Per Foot, 16.4' Equiline FlexTape® Roll, 2700K
RVTPELED-35HER	T473	3W Per Foot, 16.4' Equiline FlexTape® Roll, 3500K
RVTPELED-48HER	T414	3W Per Foot, 16.4' Equiline FlexTape® Roll, 4800K
RVTPELED-65HER	T420	3W Per Foot, 16.4' Equiline FlexTape® Roll, 6500K

EquiLine Tape 3W works with all Treco® 12VDC power supplies.

Required Items		
Item #	Quick Code	Description
RVTPEPKT-2IN1	T824	2" 12VDC Straight Starter Lead
RVLED-TPEPKT-2M	T147	79" (2 m) 12VDC Straight Starter Lead
RVLED-TPEPKT-2MTEE	T180	79" (2 m) 12VDC Tee Starter Lead

Optional Items		
Item #	Quick Code	Description
RVTPELNK-BTB	T479	Back-to-Back Connector
RVLED-TPELNK-TEE	T146	Tee Link Connector
RVLED-TPELNK-CON90	T152	90° Link Connector

Item #	Quick Code	Description
RVLED-TPELNK-5	T144	2" (5 cm) 12VDC FlexTape® Link Cord
RVLED-TPELNK-15	T141	6" (15 cm) 12VDC FlexTape® Link Cord
RVLED-TPELNK-25	T143	10" (25 cm) 12VDC FlexTape® Link Cord
RVLED-TPELNK-60	T145	24" (60 cm) 12VDC FlexTape® Link Cord
RVLED-TPELNK-120	T140	48" (120 cm) 12VDC FlexTape® Link Cord
RVLED-TPELNK-180	T142	72" (180 cm) 12VDC FlexTape® Link Cord

NOTE: Power Supplies on pages 27-31 and accessories on pages 32-43.

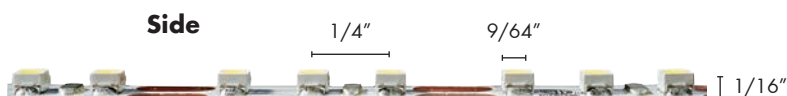

TRESCO® EUROLINX



Specifications:

Lumens: 216 per ft.

Warranty: 5 years

Lamp Life: 50,000 Hours

Beam Angle: 120°

Mounting: Surface

Linkable up to 10'

U-Clip mounted

Each light includes: 79" Starter Cord with AMP Connector and U-Clips for mounting.



Required Items		
Item #	Quick Code	Description
RVEUL3W-197CAL	T428	7.75" L, 3 Watts, 5000K
RVEUL3W-197WAL	T429	7.75" L, 3 Watts, 3000K
RVEUL4W-273CAL	T613	10.75" L, 4 Watts, 5000K
RVEUL4W-273WAL	T548	10.75" L, 4 Watts, 3000K
RVEUL7W-502CAL	T430	19.75" L, 7 Watts, 5000K
RVEUL7W-502WAL	T431	19.75" L, 7 Watts, 3000K
RVEUL11W-06CAL	T424	31.75" L, 11 Watts, 5000K
RVEUL11W-06WAL	T425	31.75" L, 11 Watts, 3000K
RVEUL15W1111CAL	T426	43.75" L, 15 Watts, 5000K
RVEUL15W1111WAL	T427	43.75" L, 15 Watts, 3000K

Power Supplies		
Item #	Quick Code	Description
RVDC-ELT6WP-CON	T543	6W Wall Mount with 3 AMP Ports Mounting Block
RVDC-ELT15WP-CON	T362	15W Wall Mount with 6 AMP Ports Mounting Block
RVDC-ELT18-CON	T100	18W with 6 AMP Ports Mounting Block
RVDC-EQ30	T605	30W Power Supply with 6 AMP Ports Mounting Block
RVDC-EQ60	T606	60W with 6 AMP Ports Mounting Block
RVDC-E30D-CON	T611	30W Wall Dimmable Hardwire Power Supply with 6 AMP Ports
RVDC-E60D-CON	T537	60W Wall Dimmable Hardwire with 6 AMP Ports

Optional Items - Link Cord, Links Two Eurolinxs Together					
Item #	Quick Code	Size	Item #	Quick Code	Size
RVEULNK-WH	T433	6"	RVEULNK-120-WH	T432	48"
RVEULNK-25-WH	T435	10"	RVEULNK-180-WH	T434	72"
RVEULNK-60-WH	T436	24"			

Item #	Quick Code	Description
RVEUL-GTD	T423	27 Watts Inline Gradual Touch Dimmer, Controls up to 6.75' of Eurolinx lights (maximum 27 watts)
RVEUL-UCLP1	T821	Extra U-Clips (2 Pack)
RVEULNK-BTBGY1	T822	Extra Back-to-Back Link



NOTE: Power Supplies on pages 27-31 and accessories on pages 32-43.

TRESCO® FINELINE 2.0

Specifications:

Lumens: 330 per ft.

Lamp Life: 50,000 Hours

Mounting: Surface

U-Clip mounted

4.4W per ft.

Warranty: 5 years

Beam Angle: 120°

Linkable up to 12'

Each light includes: 79" Starter Cord with AMP Connector and U-Clips for mounting.



Required Items - FineLine 2.0 LED Light		
Item #	Quick Code	Description
RVSTKHO8-CNI	T637	8"L, 2.93W, 5000K, Nickel Finish
RVSTKHO8-WNI	T638	8"L, 2.93W, 3000K, Nickel Finish
RVSTKHO12-CNI	T631	12"L, 4.4W, 5000K, Nickel Finish
RVSTKHO12-WNI	T632	12"L, 4.4W, 3000K, Nickel Finish
RVSTKHO22-CNI	T633	22"L, 8.07W, 5000K, Nickel Finish
RVSTKHO22-WNI	T634	22"L, 8.07W, 3000K, Nickel Finish
RVSTKHO34-CNI	T635	34"L, 12.47W, 5000K, Nickel Finish
RVSTKHO34-WNI	T636	34"L, 12.47W, 3000K, Nickel Finish

Power Supplies		
Item #	Quick Code	Description
RVDC-ELT6WP-CON	T543	6W Wall Mount with 3 AMP Ports Mounting Block
RVDC-ELT15WP-CON	T362	15W Wall Mount with 6 AMP Ports Mounting Block
RVDC-ELT18-CON	T100	18W with 6 AMP Ports Mounting Block
RVDC-EQ30	T605	30W Power Supply with 6 AMP Ports Mounting Block
RVDC-EQ60	T606	60W with 6 AMP Ports Mounting Block
RVDCE30D-CON	T611	30W Wall Dimmable Hardwire Power Supply with 6 AMP Ports
RVDCE60D-CON	T537	60W Wall Dimmable Hardwire with 6 AMP Ports

Item #	Quick Code	Description
RVLED-STKLNK-5	T138	2" Fineline Stick Linking Cord
RVLED-STKLNK-15	T135	6" Fineline Stick Linking Cord
RVLED-STKLNK-25	T137	10" Fineline Stick Linking Cord
RVLED-STKLNK-60	T139	24" Fineline Stick Linking Cord
RVLED-STKLNK-120	T134	48" Fineline Stick Linking Cord
RVLED-STKLNK-180	T136	72" Fineline Stick Linking Cord

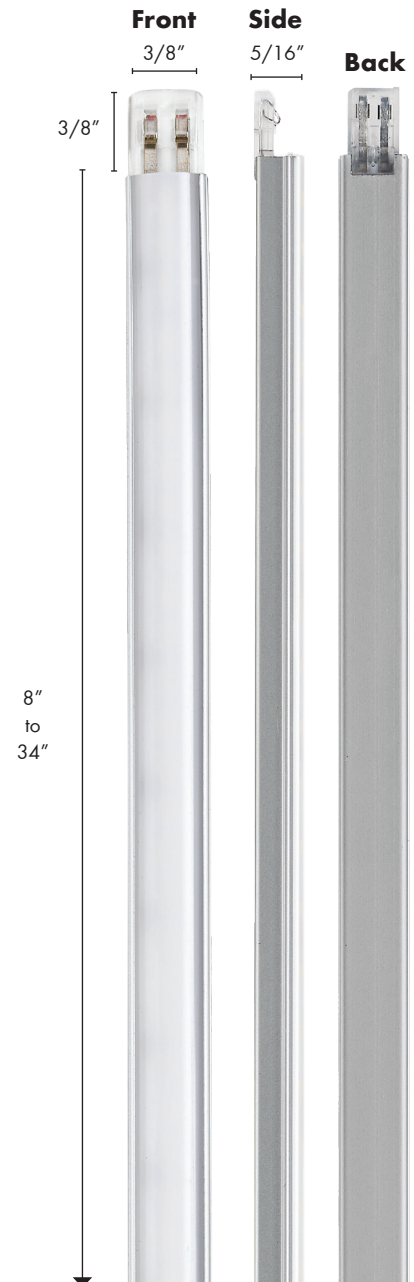

NOTE: Power Supplies on pages 27-31 and accessories on pages 32-43.

TRESCO® 3W POWER POCKET®



Front

79"

2-1/2"

Specifications:

Lumens: 234

Lamp Life: 50,000 Hours

Mounting: Recess/Surface

Warranty: 5 years

Beam Angle: 120°

Surface Mount Ring is included with each light.



Side

1/4"

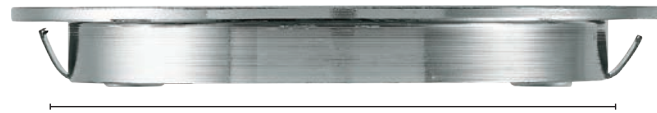

Hole Size: 2-1/4"

Item #	Quick Code	Description
3W LED Power Pocket®, 5000K		
RVPOC-3LEDSFR-CBL	T191	Black Finish
RVPOC-3LEDSFR-CNI	T232	Nickel Finish
RVPOC-3LEDSFR-CWH	T294	White Finish
3W LED Power Pocket®, 3000K		
RVPOC-3LEDSFR-WBL	T162	Black Finish
RVPOC-3LEDSFR-WCH	T293	Chrome
RVPOC-3LEDSFR-WNI	T163	Nickel Finish
RVPOC3LEDSFR-WORB	T166	Oil Rubbed Bronze Finish
RVPOC-3LEDSFR-WWH	T164	White Finish

Power Supplies		
Item #	Quick Code	Description
RVDC-ELT6WP-CON	T543	6W Wall Mount Power Supply with 3 AMP Ports Mounting Block
RVDC-ELT15WP-CON	T362	15W Wall Mount Power Supply with 6 AMP Ports Mounting Block
RVDC-ELT18-CON	T100	18W Power Supply with 6 AMP Ports Mounting Block
RVDC-EQ30	T605	30W Power Supply with 6 AMP Ports Mounting Block
RVDC-EQ60	T606	60W Power Supply with 6 AMP Ports Mounting Block
RVDC30D-CON	T611	30W Wall Dimmable Hardwire Power Supply with 6 AMP Ports
RVDC60D-CON	T537	60W Wall Dimmable Hardwire Power Supply with 6 AMP Ports

NOTE: Power Supplies on pages 27-31 and accessories on pages 32-43.

TRESCO® 3W EQUILINE PUCK



Front

79"

2-1/2"

Specifications:

- Lumens: 218
- Lamp Life: 25,000 Hours
- Mounting: Recess/Surface
- Warranty: 2 years
- Beam Angle: 100°



Side



1/2"

Hole Size: 2-1/4"

Item #	Quick Code	Description
RVPOC-3EQFR-WBL	T556	3W, 12V EquiLine Puck Light, 3000K, Black Finish
RVPOC-3EQFR-WNI	T539	3W, 12V EquiLine Puck Light, 3000K, Nickel Finish
RVPOC-3EQFR-CBL	T864	3W, 12V EquiLine Puck Light, 5000K, Black Finish
RVPOC-3EQFR-CNI	T538	3W, 12V EquiLine Puck Light, 5000K, Nickel Finish

Power Supplies		
Item #	Quick Code	Description
RVDC-ELT6WP-CON	T543	6W Wall Mount Power Supply with 3 AMP Ports Mounting Block
RVDC-ELT15WP-CON	T362	15W Wall Mount Power Supply with 6 AMP Ports Mounting Block
RVDC-ELT18-CON	T100	18W Power Supply with 6 AMP Ports Mounting Block
RVDC-EQ30	T605	30W Power Supply with 6 AMP Ports Mounting Block
RVDC-EQ60	T606	60W Power Supply with 6 AMP Ports Mounting Block
RVDC-EQ30D-CON	T611	30W Wall Dimmable Hardwire Power Supply with 6 AMP Ports
RVDC-EQ60D-CON	T537	60W Wall Dimmable Hardwire Power Supply with 6 AMP Ports

Optional Items		
Item #	Quick Code	Description
RVSMR-2LED-BLK	T645	Equiline Puck Light Surface Mount Ring, Black Finish
RVSMR-2LED-NI	T360	Equiline Puck Light Surface Mount Ring, Nickel Finish

NOTE: Power Supplies on pages 27-31 and accessories on pages 32-43.

TRESCO® POWER SUPPLIES

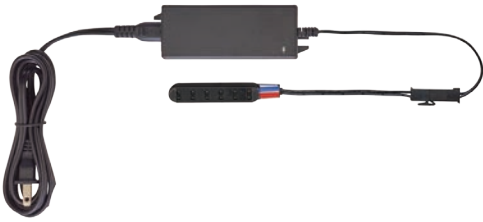

12 Volt Commercial Plug-In Power Supply 18 Watts

- 12VDC constant voltage output
- Short circuit protection*
- Overcurrent protection
- Overload protection*
- RFI protection
- Dimmable on trailing edge (12VDC side)
- **Includes: mounting block w/6 ports & 6' power cord**
- Compatible with all Tresco® low voltage dimmers
- **NOT compatible with hardwire wall dimmers**
- * Automatic reset (no fuses)



Item #	Quick Code	Description	Size
RVDC-ELT18-CON	T100	12VDC/18W Power Supply w/6 Snap Mounting Block	1-11/16"W x 1-1/4"H x 4-1/4"L



12 Volt Commercial Plug-In Power Supplies 30 Watts & 60 Watts

- Slim design, under 1" height
- 12VDC constant voltage output
- High power factor (Pf > .95)
- Short circuit protection*
- Overcurrent protection
- Overload protection*
- RFI protection
- Dimmable on trailing edge (12VDC side)
- Class 2
- **Includes: mounting block w/6 ports & 8' power cord**
- Compatible with all Tresco® low voltage dimmers
- **NOT compatible with hardwire wall dimmers**
- * Automatic reset (no fuses)



Item #	Quick Code	Description	Size	
A	RVDC-SLELT30	T625	12VDC/30W Power Supply w/Mounting Block	2-1/8"W x 13/16"H x 6-1/8"L
B	RVDC-SLELT60	T626	12VDC/60W Power Supply w/Mounting Block	2-3/8"W x 15/16"H x 7"L

TRESCO® POWER SUPPLIES



24 Volt EquiLine Plug-In Power Supply 15 Watts

- 24VDC constant voltage output
- Fully enclosed wall mount plastic case
- Single barrel connector output
- Short circuit protection*
- Overcurrent protection
- Overload protection*
- RFI protection
- Dimmable on trailing edge (24VDC side)
- Class 2, 2-Year warranty
- Compatible with all Tresco® low voltage dimmers
- **NOT compatible with hardwire wall dimmers**
- * Automatic Reset (no fuses)

10' Cord from Plug to Barrel Connector



Item #	Quick Code	Description	Size
RV24DCELT15WP	T841	24VDC/15W Wall Mnt Power Supply w/Barrel Connector	1-5/8"W x 1-1/4"H x 3"L

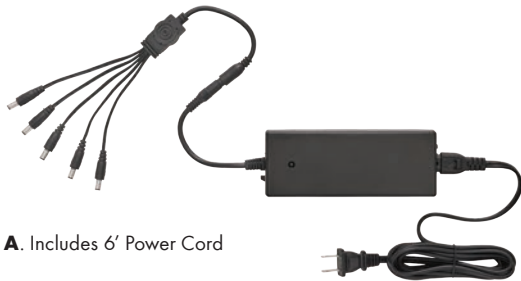

A. Includes 6' Power Cord

24 Volt Commercial Plug-In Power Supplies 48 Watts & 96 Watts

- Slim design, under 1.6" height
- 24VDC constant voltage output
- High power factor (Pf > .95) 96W only
- Short circuit protection*
- Overcurrent protection
- Overload protection*
- RFI protection
- Dimmable on trailing edge (24VDC side)
- Class 2
- **Includes: 5 barrel wires**
- Compatible with all Tresco® low voltage dimmers
- **NOT compatible with hardwire wall dimmers**
- * Automatic reset (no fuses)



B. Includes 8' Power Cord



Item #	Quick Code	Description	Size	
A	RV24DCELT48-BL	T653	24VDC/48W Power Supply w/5 Barrel Wires - Black	2-3/8"W x 1-1/2"H x 6"L
B	RV24DCELT96	T577	24VDC/96W Power Supply w/5 Barrel Wires - White	2-5/16"W x 1-5/16"H x 7-1/16"L

TRESCO® POWER SUPPLIES



12 Volt EquiLine Plug-In Power Supplies 6 Watts / 15 Watts / 30 Watts / 60 Watts



A. 10' Cord from Plug to Mounting Block



B. 10' Cord from Plug to Mounting Block

- 12VDC constant voltage output
- Short circuit protection*
- Overload protection*
- RFI protection
- Dimmable on trailing edge (12VDC side)
- Class 2
- 2-Year warranty
- **Includes: mounting block**
- Compatible with all Tresco® low voltage dimmers
- **NOT compatible with hardwire wall dimmers**
- * Automatic reset (no fuses)



C. Includes 8' Power Cord



D. Includes 8' Power Cord

	Item #	Quick Code	Description	Size
A	RVDC-ELT6WP-CON	T543	12VDC/6W Power Supply & Mnting Block w/3 Ports	1-1/2"W x 1-1/2"H x 2-3/4"L
B	RVDC-ELT15WP-CON	T362	12VDC/15W Power Supply & Mnting Block w/6 Ports	1-5/8"W x 1-1/4"H x 3"L
C	RVDC-EQ30	T605	12VDC/30W Power Supply & Mnting Block w/6 Ports	2-1/8"W x 13/16"H x 6-1/8"L
D	RVDC-EQ60	T606	12VDC/60W Power Supply & Mnting Block w/6 Ports	2-3/8"W x 15/16"H x 7"L

TRESCO® POWER SUPPLIES



A



B

12 Volt Commercial Wall Dimmable Hardwire Power Supplies 30 Watts & 60 Watts

- Under 1" height
- 12VDC constant voltage output
- High power factor (Pf > .95)
- Dimmable by standard LED wall dimmers
- Continuous smooth dimming
- Wire directly into unit, quiet operation
- Requires electrician to install
- Electronic units are lower profile and generate less heat than magnetic transformers
- Includes: mounting block w/6 ports
- Dimmable by LED line voltage (120V) wall dimmers
- RFI Protection
- Class 2 with short circuit and automatic reset

Class 2 SELV

Item #	Quick Code	Description	Size	
A	RVDCE30D-CON	T611	12VDC/30W Wall Dimmable Hardwire Power Supply	2-1/8"W x 13/16"H x 6-1/8"L
B	RVDCE60D-CON	T537	12VDC/60W Wall Dimmable Hardwire Power Supply	2-3/8"W x 15/16"H x 7"L



A



B

12 Volt Industrial Wall Dimmable Hardwire Power Supplies 60 Watts & 180 Watts

- Slim design, under 2" height
- 12VDC constant voltage output
- High power factor (Pf > .95)
- Built-in hardwire compartment
- All metal construction
- Short circuit protection*
- Overcurrent protection
- Overload protection*
- RFI protection
- Dimmable by standard LED wall dimmers
- Class 2
- Compatible with all Tresco® low voltage dimmers
- Compatible with hardwired LED wall dimmers
- Does not include mounting block
- Requires electrician to install
- * Automatic reset (no fuses)

Class 2 SELV

Item #	Quick Code	Description	Size	
A	RV12DCH60X1	T621	12VDC/60W Industrial Wall Dimmable Hardwire Power Supply	3-5/8"W x 1-11/16"H x 7-3/8"L
B	RV12DCH60X3	T622	12VDC/180W Industrial Wall Dimmable Hardwire Power Supply	4-1/4"W x 1-3/4"H x 10-15/16"L

TRESCO® POWER SUPPLIES & TERMINAL BLOCKS



24 Volt Industrial Wall Dimmable Hardwire Power Supplies 96 Watts & 288 Watts



A



B



- Slim design, under 2" height
- 24VDC constant voltage output
- High power factor (PF>.95)
- Built-in hardwire compartment
- All metal construction
- Short circuit protection*
- Overcurrent protection
- Overload protection*
- RFI protection
- Dimmable by standard LED wall dimmers
- Class 2
- Compatible with all Tresco® low voltage dimmers
- Compatible with hardwired LED wall dimmers
- Does not include 5 Output Barrel
- Requires electrician to install
- Dimmable by LED line voltage (120V) wall dimmers
- * Automatic reset (no fuses)



Item #	Quick Code	Description	Size	
A	RV24DCH96X1	T623	24VDC/96W Hardwire Wall Dimmable Power Supply	3-11/16"W x 1-11/16"H x 8-11/16"L
B	RV24DCH96X3	T624	24VDC/288W Hardwire Wall Dimmable Power Supply	4-1/4"W x 1-3/4"H x 11-15/16"L

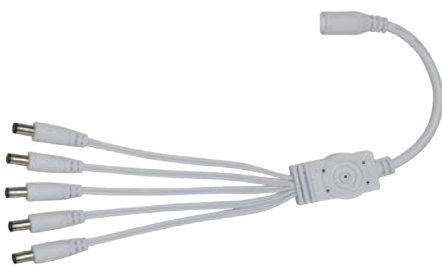

Extra 5 Output Barrel Splice

- Designed for Tresco®'s 24 Volt Power Supplies
- 5 Barrel Connector Wires

Item #	Quick Code	Description
RV1BRL5	T574	Extra 5 Output Barrel Splice



Terminal Block

- Works with Tresco® 12VDC system

Item #	Quick Code	Description	Finish
RVTRANS-MNT-BL	T179	Additional Terminal Block with 6 AMP Ports, Cord is 6" L	Black

TRESCO® SWIDGET



Tresco® is now offering Swidget “smart” outlets and switches. The outlets and switches can be controlled remotely from your mobile phone via the Swidget app.



Swidget App



With knowledge and control at your fingertips, the Swidget App allows you to control your device while monitoring power consumption accurately and in real-time.

- Power On/Off your outlet or switch
- Program schedules, create scenes and set automations
- Monitor your energy consumption and set automatic notifications including when power consumption is too high
- Connect inserts to trigger one another for a complete smart home system
- Voice control your Swidget Wi-Fi connected inserts by using Alexa, Google Assistant and IFTTT enabled devices

Swidget Set Up

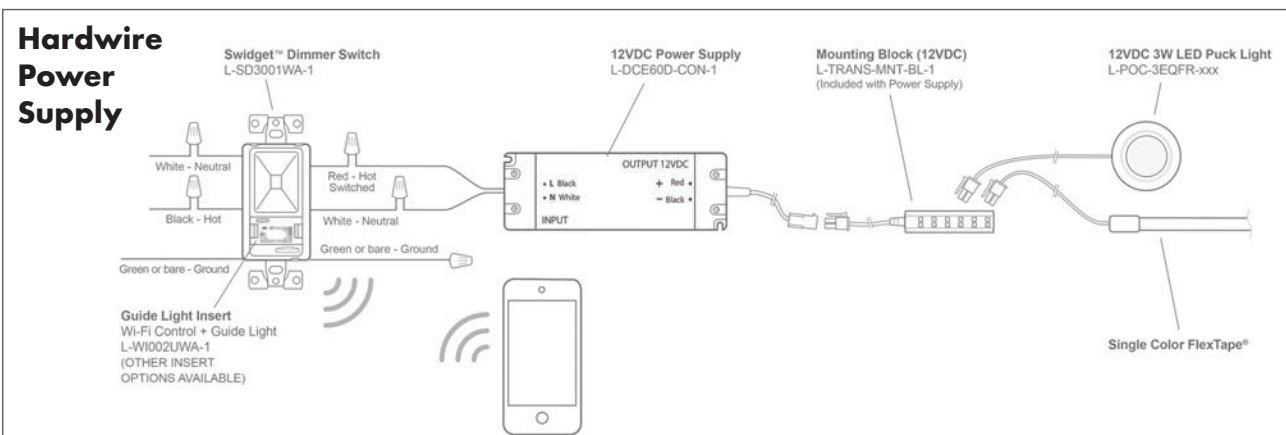
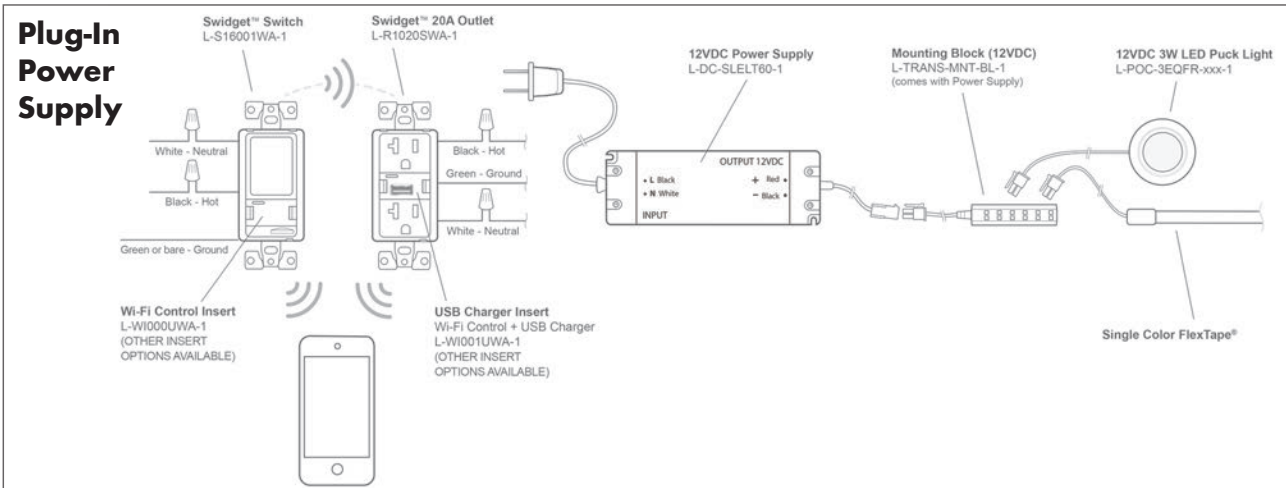

TRESCO® SWIDGET

Swidget Devices with Wi-Fi Control Inserts



Swidget Outlet w/Wi-Fi Control Insert

- Independent power monitoring for each of the (2) receptacles with Wi-Fi enabled control insert with the Swidget App
- **Top receptacle** is always “on” and allows for wireless power monitoring
- **Bottom receptacle** allows for wireless “on/off” control and power monitoring
- Fits all electrical boxes 3” x 2” x 2.5” and larger
- Tamper resistant shutters for safe operation
- Wireless Band: 2.4GHz
- Device Compatability: Amazon Alexa, Google Assistant, IFTTT
- Neutral wire required for installation
- Electrician required for install, works with all standard rocker switch plates (not included)

Item #	Quick Code	Description	Color
RVR1020WI000	T929	120VAC 20A Swidget Outlet, w/ Wi-Fi Control Insert	White



Swidget Standard Switch w/Wi-Fi Control Insert

- Single pole and 3-way wiring compatible for lighting and fan applications
- Capability for scene programming with Wi-Fi control insert
- 300W LED/CFL load rating
- Fits all electrical boxes 3” x 2” x 2.5” and larger
- Wireless Band: 2.4GHz
- Device Compatability: Amazon Alexa, Google Assistant, IFTTT
- Neutral wire required for installation
- Electrician required for install, works with all standard rocker switch plates (not included)



Item #	Quick Code	Description	Color
RVS16001WI000	T927	120VAC 300W/600W Swidget On/Off Switch w/Wi-Fi Control	White



Swidget Dimmer Switch w/Wi-Fi Control Insert

- Unique on/off/dimmer control in a single pad with the capability for scene programming with a Wi-Fi control insert
- 150W LED/CFL load rating
- Compatible with all Tresco® dimmable power supplies
- Fits all electrical boxes 3” x 2” x 2.5” and larger
- Wireless Band: 2.4GHz
- Device Compatability: Amazon Alexa, Google Assistant, IFTTT
- Neutral wire required for installation
- Electrician required for install, works with all standard rocker switch plates (not included)



Item #	Quick Code	Description	Color
RVSD300WI000	T928	120VAC 150W/300W Swidget Dimmer Switch w/Wi-Fi Control	White

TRESCO® SWIDGET

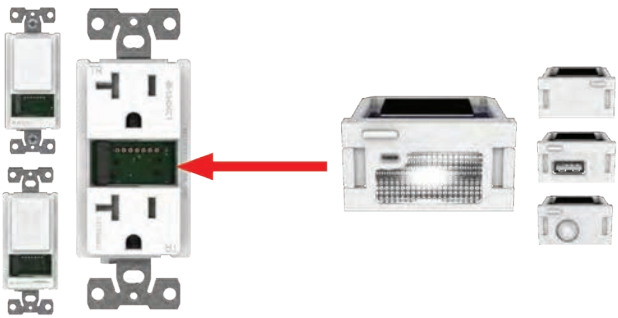

If you are looking for more options than just standard Wi-Fi Control, then Swidget Devices without Inserts are the answer. They allow you to choose Wi-Fi Inserts that have options like a USB Charger, Night Light or Motion Sensor (see Inserts on next page).



Swidget Devices without Inserts



Swidget Outlet w/o Insert (Insert on Next Page)

- Independent power monitoring for each of the (2) receptacles with Wi-Fi enabled insert (sold separately) and the Swidget App
- **Top receptacle** is always “on” and allows for wireless power monitoring
- **Bottom receptacle** allows for wireless “on/off” control and power monitoring
- Fits all electrical boxes 3” x 2” x 2.5” and larger
- Tamper resistant shutters for safe operation
- Neutral wire required for installation
- Electrician required for install, works with all standard rocker switch plates (not included)



Item #	Quick Code	Description	Color
RVR1020SWA	T922	120VAC 20A Swidget Outlet, w/o Insert	White



Swidget On/Off Switch w/o Insert (Insert on Next Page)

- Single pole and 3-way wiring compatible for lighting and fan applications
- Capability for scene programming with a Wi-Fi enabled insert (sold separately)
- 300W LED/CFL load rating
- Fits all electrical boxes 3” x 2” x 2.5” and larger
- Neutral wire required for installation
- Electrician required for install, works with all standard rocker switch plates (not included)



Item #	Quick Code	Description	Color
RVS16001WA	T921	120VAC 300W/600W Swidget On/Off Switch, w/o Insert	White



Swidget Dimmer Switch w/o Insert (Insert on Next Page)

- Unique on/off/dimmer control in a single pad with the capability for scene programming with a Wi-Fi enabled insert (sold separately)
- 150W LED/CFL load rating
- Compatible with all Tresco® dimmable power supplies
- Fits all electrical boxes 3” x 2” x 2.5” and larger
- Neutral wire required for installation
- Electrician required for install, works with all standard rocker switch plates (not included)



Item #	Quick Code	Description	Color
RVSD3001WA	T920	120VAC 150W/300W Swidget Dimmer Switch, w/o Insert	White

TRESCO® SWIDGET

Swidget Wi-Fi Inserts



Swidget Wi-Fi Control Insert

- Wi-Fi Control Insert transforms a Swidget device into a smart device
- Control an outlet (lights, appliances or anything plugged in) from anywhere
- Wireless Band: 2.4GHz
- Device Compatibility: Amazon Alexa, Google Assistant, IFTTT



Item #	Quick Code	Description	Color
RVW1000UWA	T923	Swidget Wi-Fi Control Insert	White



Swidget Wi-Fi Control + USB Charger Insert

- Type A USB connector to allow for fast-charging of your devices
- USB output up to a 2.0A rating
- Class 2 output certified
- Wireless Band: 2.4GHz
- Device Compatibility: Amazon Alexa, Google Assistant, IFTTT



Item #	Quick Code	Description	Color
RVW1001UWA	T924	Swidget Wi-Fi Control + USB Charger Insert	White



Swidget Wi-Fi Control + Guide/Night Light Insert

- Basic night light functionality with automatic light sensor trigger
- Warm white high efficient LED
- Wireless Band: 2.4GHz
- Device Compatibility: Amazon Alexa, Google Assistant, IFTTT



Item #	Quick Code	Description	Color
RVW1002UWA	T925	Swidget Wi-Fi Control + Guide/Night Light Insert	White



Swidget Wi-Fi Control + Motion Sensor Insert

- Wireless Infrared Detection (PIR) Panasonic Motion Sensor
- Occupancy/Vacancy detection
- Vacancy timer adjustable between 1-60 minutes
- 120-degree detection angle with a 10' (3 m) detection range
- When connected to Wi-Fi, it can be used to create sensor-based automations, where motion or occupancy can trigger actions in switches, outlets, send notifications and more
- Automatically turns on lights when someone enters or turns off lights when no motion is detected
- Wireless Band: 2.4GHz
- Device Compatibility: Amazon Alexa, Google Assistant, IFTTT



Item #	Quick Code	Description	Color
RVW1004UWA	T926	Swidget Wi-Fi Control + Motion Sensor Insert	White

TRESCO® 120 VOLT LED WALL DIMMERS



Lutron Diva® C-L™ Dimmer 150 Watts

- Large paddle switch with a captive linear-slide dimmer for a standard designer wall plate opening
- Switch returns light to preset light level
- Offers more reliable dimming performance over standard dimmers
- HED™ technology with advanced dimming circuitry designed for compatibility with most high-efficiency light bulbs
- Adjustment switch to modify the minimum light level in order to maximize the dimming range if flickering occurs at lower dimming levels

Item #	Quick Code	Description
RVDVCL-153PH-WH	T321	150W Lutron Diva® Dimmer without plate



Lutron Skylark Contour Diva® C-L™ Dimmer 150 Watts

- On/off rocker switch with a captive linear-slide dimmer for a standard designer wallplate opening
- Switch returns light to preset light level
- Offers more reliable dimming performance over standard dimmers
- HED™ technology with advanced dimming circuitry designed for compatibility with most high-efficiency light bulbs
- Low-end adjustment dial

Item #	Quick Code	Description
RVCTCL-153P-WH	T320	150W Lutron Skylark Dimmer without plate



Leviton Decora® LED Dimmer 300 Watts

- Large paddle switch with a captive linear-slide dimmer for a standard designer wall plate opening
- Packaged with White, Ivory, and Light Almond color change kits
- Switch returns light to preset light level
- No neutral wire required for installation
- Adjustment switch to modify the minimum light level in order to maximize the dimming range if flickering occurs at lower dimming levels

Item #	Quick Code	Description
RVDSL06-1LZ	T608	300W Leviton Decora® Dimmer w/WH-IV-LA Color Kits

TRESCO® FREEDiM

Installation Set-Up for FREEDiM Wireless Controllers (Micro Dimmer, Deco Wall Dimmer & Multi-Zone Remote)

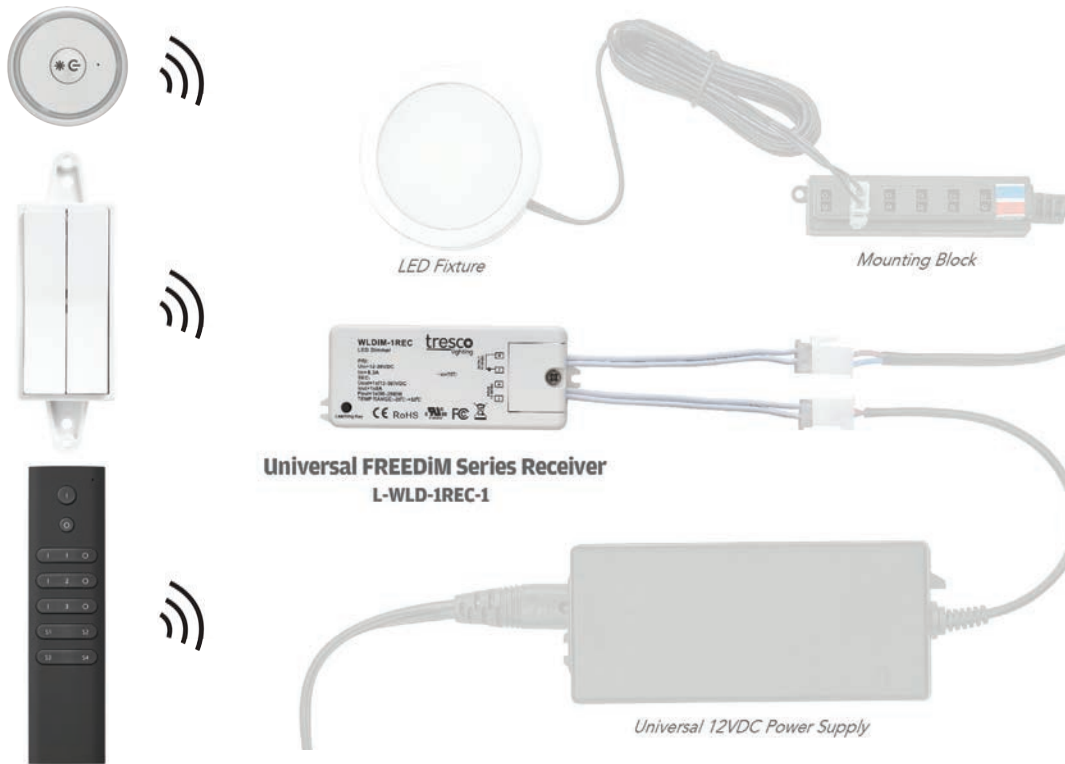

Micro Dimmer

- Single zone wireless dimmer
- Sleek Black or Nickel finish
- Easy to replace, long life lithium battery
- 65 ft. range of control from dimmer to receiver
- Mounting case can be mounted with screws or to a metallic surface
- A single dimmer can be programmed to up to 10 different receivers; a single receiver can be programmed to up to 8 different dimmers
- Required Component: Universal Receiver, must purchase to operate Micro Dimmers



A



B



C

Item #	Quick Code	Description	
A	RVWLD-1RND-BL	T494	0-100% Dim and On/Off Switch, Includes Lithium Battery (Type CR2025), Black Finish
B	RVWLD-1RND-NI	T495	0-100% Dim and On/Off Switch, Includes Lithium Battery (Type CR2025), Nickel Finish
Required Component: Must purchase the Universal Receiver in order to operate the Micro Dimmer			
C	RVWLD-1REC	T496	60 Watts, 12VDC, Universal Receiver (Must purchase to operate Micro Dimmer)

TRESCO® FREEDIM



FREEDIM
WIRELESS CONTROL



Deco Wall Dimmer

- Single & Two zone wireless dimmers
- Sleek Black, White or Light Almond finish
- Easy to replace, long life lithium battery
- 65 ft. range of control from dimmer to receiver
- Can be mounted to standard wall electrical boxes or directly to drywall
- A single dimmer can be programmed to up to 10 different receivers; a single receiver can be programmed to up to 8 different dimmers
- Required Component: Universal Receiver, must purchase to operate Deco Wall Dimmers

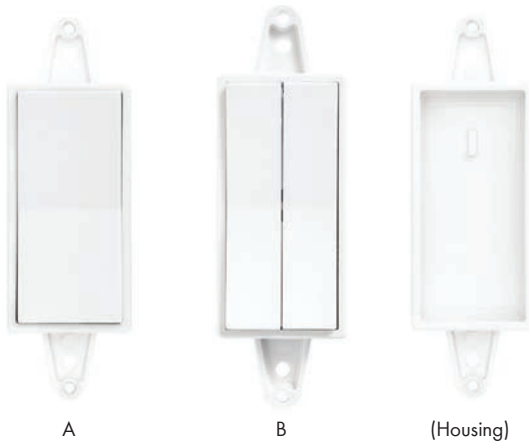

Item #	Quick Code	Finish	
Single Zone - 0-100% Dim and On/Off Switch, Includes Lithium Battery (Type CR1620)			
A	RVWLD-1WAL-WH	T530	White Finish
	RVWLD-1WAL-BL	T531	Black Finish
	RVWLD-1WAL-AL	T532	Light Almond Finish
Two Zone - 0-100% Dim and On/Off Switch, Includes Lithium Battery (Type CR1620)			
B	RVWLD-2WAL-WH	T541	White Finish
	RVWLD-2WAL-LA	T542	Light Almond Finish
Required Component: Must purchase the Universal Receiver in order to operate the Deco Wall Dimmer			
C	RVWLD-1REC	T496	60 Watts, 12VDC, Universal Receiver (Must purchase to operate Deco Wall Dimmer)



(Back Side)

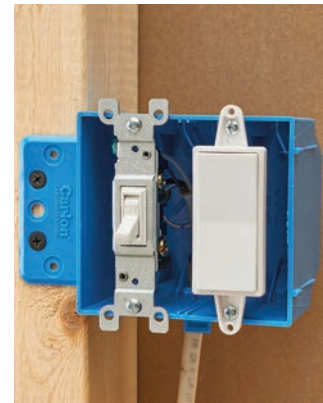
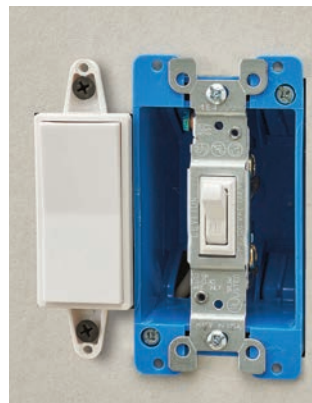



Multi-Zone Remote

- Independent control of three lighting zones from single remote
- Program additional Receivers to separate the lighting in a room into multiple Zones that you can control independently
- Set brightness levels of all of the Zones to a desired level then save as a "Scene"
- Integrated magnet allows for mounting to refrigerator or other metallic surfaces
- Includes: magnetic mounting tray that can be screw mounted
- 65 ft. range of control from remote to Receiver
- Required Component: Universal Receiver, must purchase to operate Multi-Zone Remote

tresco
lighting

FREEDIM
WIRELESS CONTROL



A. 3-Zone Remote (Back Side)

Magnetic Mounting Tray



B

Item #	Quick Code	Description	
A	RWWLD-3RMT-BL	T646	3-Zone Remote Dimmer, 0-100% Dim and On/Off Switch, Includes Magnetic Mounting Tray and Lithium Battery (Type CR2032)
Required Component: Must purchase the Universal Receiver in order to operate the Multi-Zone Remote			
B	RWWLD-1REC	T496	60 Watts, 12VDC, Universal Receiver (Must purchase to operate Multi-Zone Remotes)

TRESCO® FREEDiM

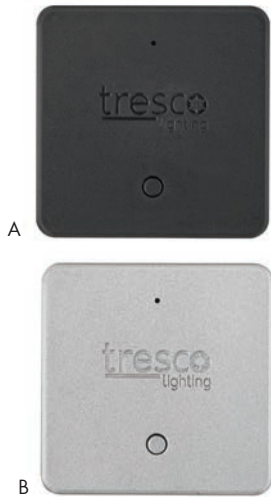

Wireless Door Sensor

- Allows light to be controlled by multiple doors
- Simple push-button pairing with receiver (sold separately)
- Program up to (4) sensors to a single receiver
- No cumbersome, messy wires to have to hide inside your cabinetry
- Mounting hardware (included)
- **Required Component: Wireless Door Sensor Receiver (see below)**

	Item #	Quick Code	Description	Size
A	RVWLDS-BL	T615	FREEDiM Wireless Door Sensor - Black Finish	1-13/16" Sq. x 5/8"H
B	RVWLDS-NI	T614	FREEDiM Wireless Door Sensor - Nickel Finish	1-13/16" Sq. x 5/8"H



Wireless Door Sensor Receiver

- 60W capacity (12VDC); 96W capacity (24VDC)
- Power failure memory
- Install inline between power supply and lights
- Simple one button pairing with Wireless Door Sensors
- Single receiver can be programmed with up to (4) sensors
- Allows for up to 4 doors to control the same light fixtures
- **Required component for Wireless Door Sensors**

Item #	Quick Code	Description	Size
RVWLDSREC	T616	12/24VDC Wireless Door Sensor Receiver	1-3/8"W x 7/8"H x 3-1/4"L

Installation Set-Up for FREEDiM Wireless Door Sensors

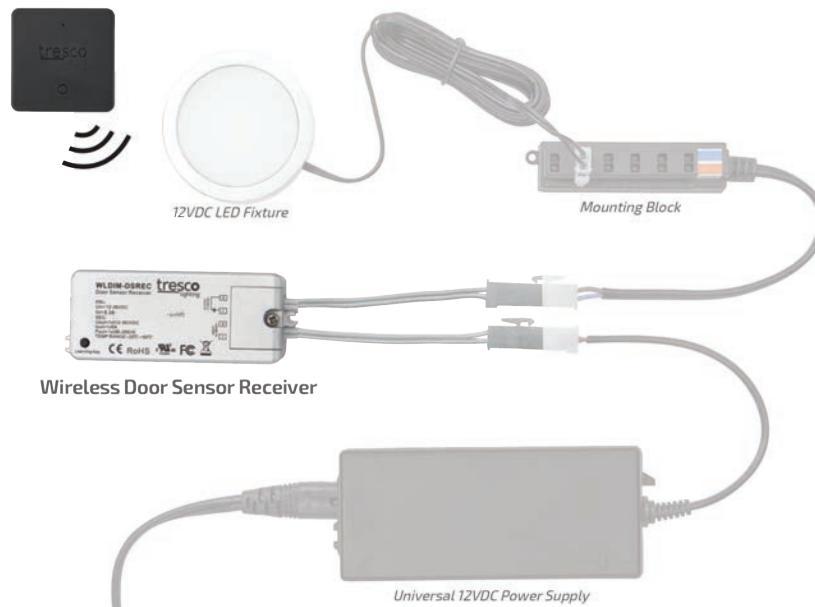

TRESCO® ROUND CONTROLLERS



Round Controller, Single Door Sensor

- Max Wattage: 12VDC/60W; 24VDC/96W
- Recessed bore hole size: 1/2"
- Includes: (1) 79" input cord, (1) 6" output cord, (1) 39" extension cord and (1) surface mount clip
- Door open, light on; door closed, light of (sensor range: 1/16" - 2")

Item #	Quick Code	Description	Finish
RVRSDS-BL	T974	Single Door Sensor	Black
RVRSDS-NI	T975	Single Door Sensor	Nickel



Round Controller, Two Door Sensor

- Max Wattage: 12VDC/60W; 24VDC/96W
- Recessed bore hole size: 1/2"
- Includes: (1) 79" input cord, (1) 6" output cord, (2) 39" extension cord and (2) surface mount clip
- Either door open, light on; both doors closed, light of (sensor range: 1/16" - 2")

Item #	Quick Code	Description	Finish
RVRSDS2-BL	T976	Two Door Sensor	Black
RVRSDS2-NI	T977	Two Door Sensor	Nickel



Round Controller, Touch Dimmer

- Max Wattage: 12VDC/60W; 24VDC/96W
- Recessed bore hole size: 1/2"
- Includes: (1) 79" input cord, (1) 6" output cord, (1) 39" extension cord and (1) surface mount clip
- Touch on/off and 0-100% dimming control (hold finger down for dimming)
- Touch dimmer once to turn on/off (power failure memory, retains last setting)

Item #	Quick Code	Description	Finish
RVRSDIM-BL	T978	Touch Dimmer	Black
RVRSDIM-NI	T979	Touch Dimmer	Nickel



Round Controller, Motion Sensor

- Max Wattage: 12VDC/60W; 24VDC/96W
- Recessed bore hole size: 1/2"
- Includes: (1) 79" input cord, (1) 6" output cord, (1) 39" extension cord and (1) surface mount clip
- Turns on when human motion is detected (sensor range: 0" - 118")
- Viewing degree: 120° (time on: 30 secs if no motion)

Item #	Quick Code	Description	Finish
RVRSMOT-NI	T980	Motion Sensor	Nickel

TRESCO® DIMMER SWITCHES

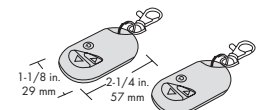
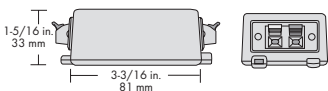
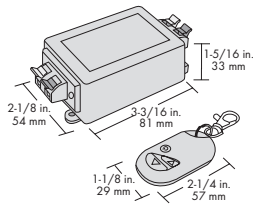

12VDC Remote Control Dimmers

Remote Control LED Dimmers feature radio-frequency, remote-control dimming to adjust lights from anywhere in the room up to 30' (9 m). The remote control provides on/off power and dims lights from 100%-1%.

Universal Remote Dimmer

- Controls up to 5A/60W of LED lighting
- Features a built-in memory that recalls the last setting when turned on
- Comes with two remote controls (one extra, as a backup)
- No line of sight required
- Can control multiple dimmers in same room with single remote control for universal dimming

Dedicated Remote Dimmer

- Controls up to 5A/60W of LED lighting
- Features a built-in memory that recalls the last setting when turned on
- No line of sight required
- Comes with two remote controls (one extra, as a backup) that are synchronized to control the same dimmer
- Can use multiple independently controlled dimmers in the same room

* Recommended not to exceed 3 per room

Placement of multiple dimmers in a room may be critical for proper function depending on set-up and obstacles.

Item #	Quick Code	Description
RVLEDDIMRMT-12V8A	T148	LED Dedicated Dimmer
RVLEDDIMRMT12V8AU	T149	LED Universal Dimmer

Both models of the Remote Control LED Dimmer provide on/off power and dim lights from 100%-1%. The dedicated Remote Control independently controls one specific dimmer in a room. The Universal Remote Control (U) controls multiple dimmers in a room.

12VDC Manual In-Line Rotary Dimmer

- 4A/48W capacity
- 100-0% dimming and on/off power
- 79" (2 m) input lead snaps into power supply mounting block with male AMP® connector
- 8" (203 mm) output connects to run of light with female AMP® connector

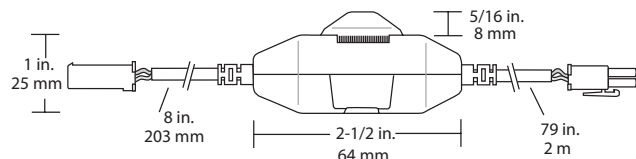
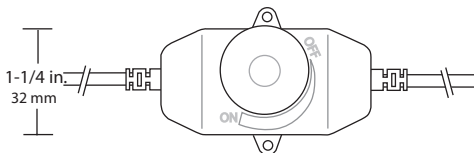

Item #	Quick Code	Description
RVLED-DIMCON-BL	T114	LED Black Inline Rotary Dimmer, 12VDC 48W
RVLED-DIMCON-WH	T115	LED White Inline Rotary Dimmer, 12VDC 48W

TRESCO® ON/OFF SWITCHES & EXTENSION CORDS



Round On/Off Switch - 12V

- 3/4" hole required



Front View



Available in White & Black

Item #	Quick Code	Description
RVRDSW-2M-BL	T167	Black Rocker Switch w/ 79" (2 m) Lead, 12VAC/DC
RVRDSW-2M-WH	T168	White Rocker Switch w/ 79" (2 m) Lead, 12VAC/DC



Starter/Extension Cord

- Low-voltage wire, hole size 1/2"
- Used to extend the starter leads for any Tresco® 12VDC lights
- Seven lengths to choose from

Item #	Quick Code	Description
RVLED-LINKD-8	T351	3" (8 cm) 12VDC Starter/Link/Extension Cord
RVLED-LINKD-15	T844	6" (15 cm) 12VDC Starter/Link/Extension Cord
RVLED-LINKD-25	T194	10" (25 cm) 12VDC Starter/Link/Extension Cord
RVLED-LINKD-60	T195	24" (60 cm) 12VDC Starter/Link/Extension Cord
RVLED-LINKD-120	T203	48" (120cm) 12VDC Starter/Link/Extension Cord
RVLED-LINKD-180	T190	72" (180cm) 12VDC Starter/Link/Extension Cord
RVLEDLINKD-245	T447	96" (245 cm) 12VDC Starter/Link/Extension Cord

Now Offering FREE Lighting Layout Assistance!

Because application of LED lighting is new to many design professionals, Tresco® is now offering Lighting Layout Assistance to help specify Tresco® products for both residential and commercial lighting design projects. trescolighting.com/layout

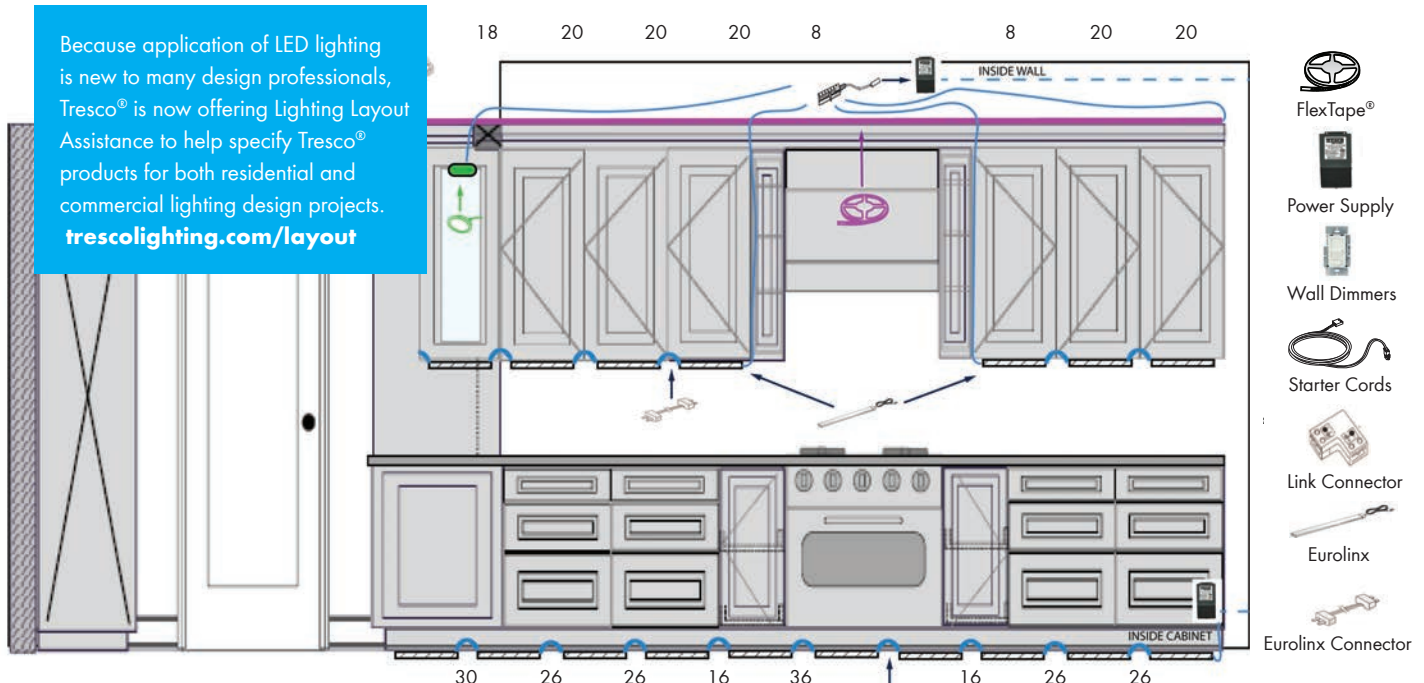



tresco
lighting



WÜRTH LOUIS AND COMPANY

TRESCO® Catalog

Würth Louis and Company

895 Columbia Street
Brea, CA 92821
(714) 529-1771
(800) 422-4389
Fax: (800) 446-9452
www.wurthlac.com

Other locations:

Anaheim, CA
Benton, AR
Boise, ID
Denver, CO
Grand Prairie, TX
Houston, TX

Idaho Falls, ID
Lacey, WA
Las Vegas, NV
Oklahoma City, OK
Phoenix, AZ
Portland, OR

Post Falls, ID
Salt Lake City, UT
San Antonio, TX
San Marcos, CA
St. George, UT
West Jordan, UT

Source Code: LP1606