

HAND TOOLS

Würth Louis and Company



Contents

4 - 15	WRENCHES
16 - 17	ALLEN KEYS
18	RIVETERS
19 - 28	SCREWDRIVERS
29 - 32	T-HANDLES
33 - 35	BITS
36 - 37	RATCHETS
38 - 53	SOCKETS
54 - 65	PLIERS/CUTTERS
66	LIMITED EDITION SETS



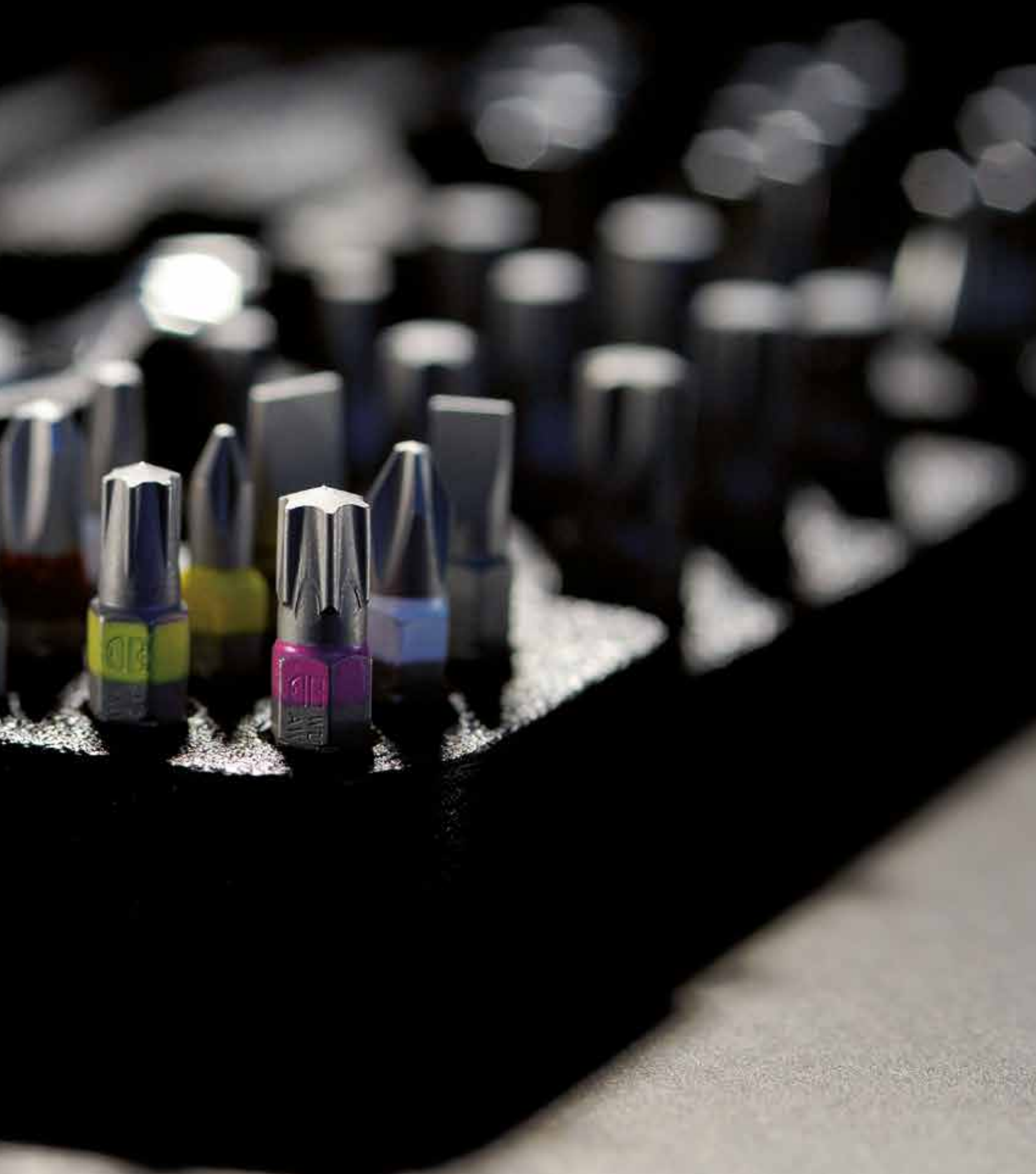

ZEBRA POWERDRIV® COMBINATION WRENCH - EXTRA SLIM

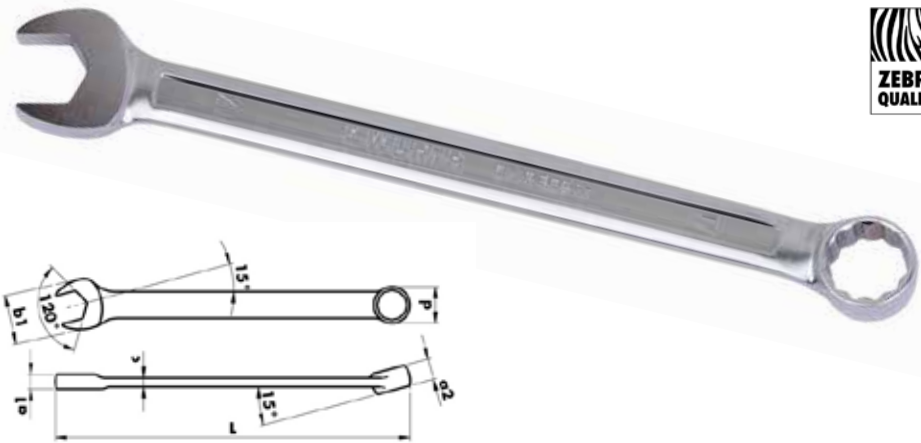

Metric, ultra slim shape

Allows for easy access and usability in hard-to-reach places

- Drive: Box end **POWERDRIV®** 12 point.
 - Standard: DIN 3113A / ISO 3318/7738
 - Geometry: Box end 15 ° angled, open-end position 15 °
 - Material: Chrome vanadium steel
 - Surface: Chrome-plated, matte satin finish
- Packing & Sold in: Each

Item #	 (mm)	L (mm)	a1 (mm)	a2 (mm)	b (mm)	c (mm)	Dia. d (mm)
WR071330908	8	139	4.2	6.5	14.7	2.6	12
WR071330916	16	206	7	12.1	29.2	4.3	22.3
WR071330918	18	233	8	13.1	32.2	4.7	25.3
WR071330919	19	244		13.5	33.7	5	26.8

ZEBRA DOUBLE OPEN-END WRENCH ASSORTMENT



Metric

12 pieces, with plastic holder

- Standard: DIN 3110 / ISO 1085
- Material: Chrome-vanadium steel
- Surface finish: Chrome-plated polished heads
- Open-end position 15°, strong heads for heavy duty use

Packing & Sold in: Each

Item #	Set	in mm
WR071330443	12 pieces	6x7, 8x9, 10x11, 12x13, 14x15, 16x17, 18x19, 20x22, 21x23, 24x27, 25x28, 30x32

POWERDRIV® (12-POINT) DOUBLE BOX END WRENCH - EXTRA LONG



Universal joint shaft flange, axle, ball and suspension joints, axle linkages

For high tightening and release forces

- Metric
- Drive: Double box end **POWERDRIV®** 12-point
- Standard: Wrench size according to DIN 475 Part II
- Material: Chrome-vanadium steel
- Surface: Body chromed, matte satin
- Geometry: Straight, very slim box-end design for hard to reach places

Packing & Sold in: Each

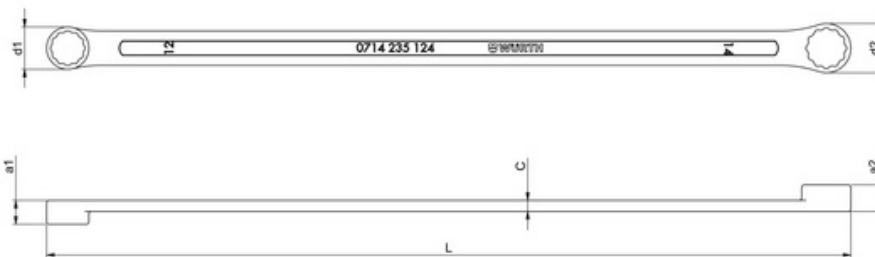

Item #	WR0714235101	WR0714235124	WR0714235135	WR0714235168	WR0714235179
Size	10 x 11 mm	12 x 14 mm	13 x 15 mm	16 x 18 mm	17 x 19 mm
Outside diameter d1	15 mm	17.2 mm	20 mm	22.6 mm	26 mm
Outside diameter d2	18.1 mm	20 mm	21.6 mm	26 mm	26.5 mm
Thickness a1	8 mm	9.7 mm	11 mm	12.3 mm	13.8 mm
Thickness a2	9 mm	10.8 mm	12 mm	13.3 mm	14 mm
Shank thickness c	4mm	4.5 mm	5 mm	5 mm	5.4 mm
Length l	292 mm	327 mm	367 mm	388 mm	410 mm

ZEBRA POWERDRIV® (12-POINT) COMBINATION WRENCH SET - SHORT TYPE (8 PIECES - 3/8, 7/16, 1/2, 9/16, 5/8, 11/16, 3/4, 7/8 INCH)



Standard

8 piece set

- Standard: DIN 3113A/ISO 3318/773
- Drive: Box end **POWERDRIV®** (12-Point)
- Material: Chrome-vanadium steel
- Surface: Chrome-plated, polished
- Geometry: Box end angled 15°, open end offset 15°

Packing & Sold in: Each

Item #	⚙️ (in.)
WR071330340	3/8, 7/16, 1/2, 9/16, 5/8, 11/16, 3/4, 7/8

ZEBRA POWERDRIV® COMBINATION WRENCH - SHORT TYPE

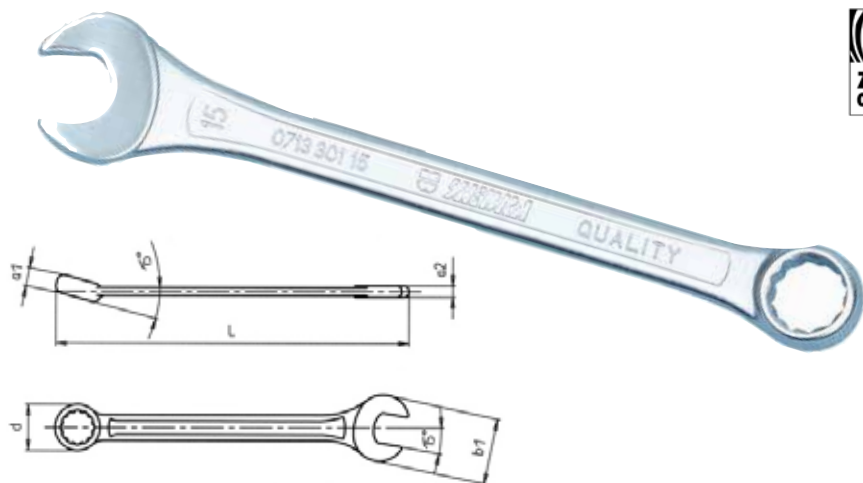

Metric

- Standard: DIN 3113A/ISO 3318/7738
- Drive: Box end **POWERDRIV®** (12-Point)
- Material: Chrome-vanadium steel
- Surface: Chrome-plated, polished heads and ring
- Geometry: Box end angled 15°, head angle 15°

Packing & Sold in: Each

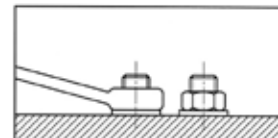
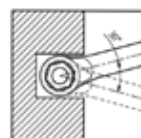

Item #	⌀ (mm)	L (mm)	b1 (mm)	Dia. d (mm)	a1 (mm)	a2 (mm)
WR0713301055	5.5	100	14.0	10.5	5.5	3.7
WR071330106	6					
WR071330107	7	110	16.0	11.8	6.0	4.0
WR071330108	8	120	18.0	13.2		
WR071330109	9	130	20.0	14.6	7.0	4.5
WR071330110	10	140	22.5	16.1	7.5	
WR071330111	11	150	25.0	17.4	8.0	5.0
WR071330112	12	160	27.0	18.9	8.5	5.5
WR071330113	13	170	29.0	20.4	9.0	
WR071330114	14	180	31.0	21.6	9.5	6.0
WR071330115	15	190	33.5	22.9	10.0	
WR071330116	16	200	36.0	24.6	10.5	6.5
WR071330117	17	205	38.0	26.1		
WR071330118	18	215	40.0	27.7	11.0	7.0
WR071330119	19	230	42.0	29.9	11.5	7.5
WR071330120	20	240	45.0	30.7	12.0	8.0
WR071330121	21	250	47.0	32.2	12.5	
WR071330122	22	260	49.0	33.7	13.5	
WR071330123	23	270	51.0	35.2	14.0	
WR071330124	24	280	53.0	36.9	14.5	9.0
WR071330125	25	290	55.0	38.5	15.0	
WR071330126	26	300	57.0	39.8	15.5	
WR071330127	27	310	59.0	40.8		
WR071330128	28	320	62.0	42.8	16.0	10.0
WR071330129	29	330	63.5	43.8	16.5	
WR071330130	30	340	65.0	44.8	17.0	11.0
WR071330132	32	350	69.0	47.8	17.5	
WR071330134	34	360	73.0	50.8	18.0	12.0



ZEBRA POWERDRIV® COMBINATION WRENCH - SHORT TYPE



Standard

- Standard: DIN 3113A/ISO 3318/773
 - Drive: Box end **POWERDRIV®**, 12-point
 - Material: Chrome-vanadium steel
 - Surface: Chrome-plated, polished
 - Geometry: Box end angled 15°, open-end offset 15°
- Packing & Sold in: Each

Item #	Ø (in.)	L (mm)	b1 (mm)	Ø d (mm)	α1 (mm)	α2 (mm)
WR071330303	3/8"	140	22.5	16.1	7.5	4.5
WR071330304	7/16"	150	25	17.4	8	5
WR071330305	1/2"	170	29	20.4	9	5.5
WR071330306	9/16"	180	31	21.6	9.5	6
WR071330307	5/8"	200	36	24.6	10	6
WR071330308	11/16"	205	38	26.1	10.5	6.5
WR071330309	3/4"	230	42	29.9	11.5	7.5
WR071330311	7/8"	260	49	33.7	13.5	8

ZEBRA POWERDRIV® COMBINATION WRENCH ASSORTMENT - SHORT TYPE



Metric

11 pieces, with plastic holder

- Box end **POWERDRIV®** (12 point)
- Standard: DIN 3113A/ISO 3318/7738
- Material: Chrome-vanadium steel
- Surface Finish: Chrome-plated polished heads
- Open-end position 15°, strong heads for heavy duty use
- 12-Point box-end and open-end position of 15° for an optimal grip ratio, resulting in minimal rotating angle
- The 15° angle of the box end provides more free space for the fingers or to work around obstacles

Packing & Sold in: Each

Item #	Set	Ø (mm)
WR071330140	11 pieces	8, 9, 10, 11, 12, 13, 14, 15, 17, 19, 22

ZEBRA POWERDRIV® (12-POINT) DUAL RATCHET COMBINATION WRENCH



Innovative wrench with ratchet function on the box and open sides.

- Drive: Box end POWERDRIV® modified 12 point, open side with open ratchet segment
- Standard: Max. torque as per DIN 899
- Material: Chrome-vanadium steel
- Surface: polished, chrome-plated
- Geometry: Straight on box end, 15° angle on open end
- To change the turning direction, simply turn the wrench around
- Open side features moving ratchet segment
- Enables working without stopping, as the wrench no longer needs to be taken off the nut. Ideal for all line screw joints
- Fine-toothed on ring side, 72 teeth, 5° rotating angle
- Very rugged and strong ratchet for high tightening torques

Packing & Sold in: Each

Areas of use

- Designed for union screw joints, e.g. brake lines, injection lines, air conditioning, hydraulics etc.

Item #	C (mm)					
		L (mm)	a1 (mm)	a2 (mm)	Dia. d (mm)	b1 (mm)
WR071425908	8	140	4.1	6.5	16.8	16.7
WR071425909	9	149	4.3	6.9	18.8	18.7
WR071425910	10	158	4.8	7.3	20.8	20.8
WR071425911	11	165	5.1	7.7	21.8	23.5
WR071425912	12	171	5.3	8.2	22.8	24.6
WR071425913	13	178	5.9	8.6	24.8	26.8
WR071425914	14	190	6.3	9.0	27.8	29.0
WR071425915	15	199	6.6	9.4	28.8	31.0
WR071425916	16	208	6.9	9.9	30.8	33.0
WR071425917	17	225	7.3	10.3	31.8	35.5
WR071425918	18	236	7.8	10.7	32.8	37.5
WR071425919	19	247	8.3	11.2	33.8	39.4
WR071425921	21	289	8.8	13.0	40.0	45.8
WR071425922	22					
WR071425924	24	322	9.8	14.5	46.0	51.8

ZEBRA POWERDRIV® (12-POINT) DUAL RATCHET COMBINATION WRENCH ASSORTMENT



Innovative wrench with ratchet function on the box and open ends

6 pieces, with plastic holder

- 1 ratchet combination wrench with double-ended ratchet function in each of the following sizes: 8; 10; 12; 13; 17; 19

Packing & Sold in: Each

Item #	Set	(mm)
WR071425950	6 pieces	8, 10, 12, 13, 17, 19 mm including plastic holder

ZEBRA POWERDRIV® RATCHET COMBINATION WRENCH - FLEXIBLE JOINT

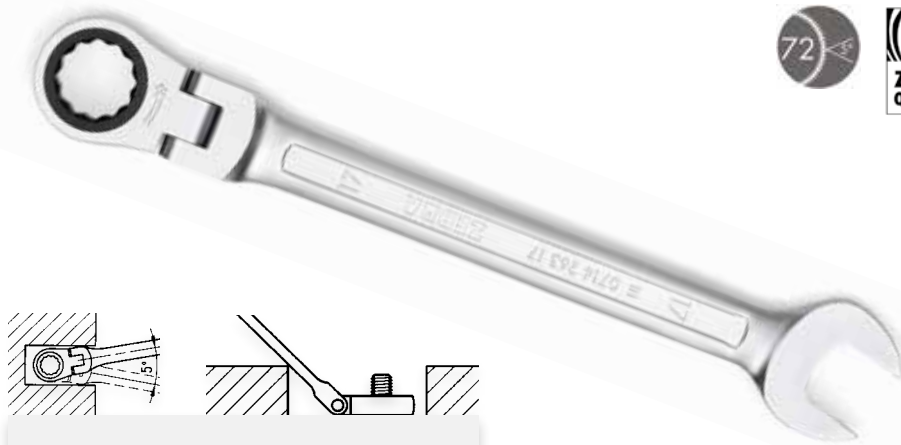

Flexible joint ratchet head provides greater freedom for fingers and overcomes obstacles

- Very rugged, strong ratchets for high tightening torques
- Design: Metric
- Drive: Box end POWERDRIV® 12-point, fine-tooth 72 teeth
- Standard: Max. torque in line with DIN 899
- Material: Chromium-vanadium steel
- Surface: Chrome-plated, matte satin finish
- Geometry: Open-end offset 15°, box end 180° joint, strong heads for heavy-duty applications

Packing & Sold in: Each

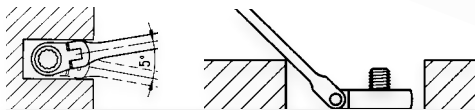

The 180° flexible joint of the box end of the wrench allows for easy access to tight areas.

Attention: This is a special tool that may not be subjected to loads in excess of maximum torque values. For that reason, the tool is of limited suitability for loosening of tight screws.

Item #	Sockets (mm)	Dimensions (mm)					
		L	a1	a2	d	b1	F max. Nm
WR071426308	8	140	4.3	6.5	16.1	16.7	35
WR071426309	9	150	4.6	6.9	17.9	18.8	46
WR071426310	10	159	5.0	7.3	19.6	20.9	59
WR071426311	11	165	5.4	7.7	21.4	23.0	74
WR071426312	12	172	5.8	8.2	22.7	25.1	91
WR071426313	13	178	6.1	8.6	24.7	27.2	109
WR071426314	14	191	6.4	9.0	26.4	29.3	131
WR071426315	15	200	6.9	9.4	27.7	31.3	153
WR071426316	16	208	7.2	9.9	29.4	33.4	179
WR071426317	17	226	7.6	10.3	31.2	35.5	205
WR071426318	18	237	8.0	10.7	32.4	37.6	235
WR071426319	19	248	8.6	11.2	33.4	39.7	266
WR071426321	21	274	9.0	13.0	39.7	46.0	330
WR071426322	22						368
WR071426324	24	296	10.0	14.5	45.9	52.3	451

ZEBRA POWERDRIV® RATCHET COMBINATION WRENCH ASSORTMENT - FLEXIBLE JOINT



Flexible Joint

6 pieces, with plastic holder

- 1 ratchet combination wrench in each of the following sizes: 8; 10; 12; 13; 17; 19

Packing & Sold in: Each

Item #	Set	Sockets (mm)
WR071426350	6 pieces	8, 10, 12, 13, 17, 19 mm

ZEBRA HEXAGON POWERDRIV® DOUBLE OPEN END LINE WRENCH



Metric

- Drive: Hexagon **POWERDRIV®**
 - Standard: DIN 3118
 - Geometry, open end profile angled 15°, open end angled 5°
 - Material: Chrome-vanadium steel
 - Surface: Chrome-plated, polished heads
- Packing & Sold in: Each



Item #	⊙ ⊚ (mm)								
		L (mm)	a1 (mm)	a2 (mm)	Dia. d1 (mm)	Dia. d2 (mm)	B1 min. (mm)	B2 min. (mm)	
WR0714240079	7 x 9	140	6.5	7.5	17.8	19.3	5	7	
WR0714240080	8 x 10						6		
WR0714240113	11 x 13	174	8.5	10.5	22.8	25.3	9	11	
WR0714240124	12 x 14								
WR0714240179	17 x 19	212	12	13	31.2	33.3	14	15	

ZEBRA HEXAGON POWERDRIV® DOUBLE OPEN END LINE WRENCH ASSORTMENT



Metric

5 pieces, with plastic holder

- Drive: Hexagon **POWERDRIV®**
- Standard: DIN 3118
- 1 each of double open end ring wrench size: 7 x 9, 8 x 10, 11 x 13, 12 x 14, 17 x 19
- Packing & Sold in: Each



Item #	Set	⊙ ⊚ (mm)
WR071424050	5 pieces	7 x 9, 8 x 10, 11 x 13, 12 x 14, 17 x 19

WRENCHES
ALLEN KEYS
RIVETERS
SCREWDRIVERS
T-HANDLES
BITS
RATCHETS



273308

0713 308

0713 308 22

E V

0713 308 19

17

ZEBRA POWERDRIV® (12-POINT) DOUBLE BOX END WRENCH - DEEP OFFSET



Metric, DIN 838/ISO 3318

- Drive: **POWERDRIV®**, 12 point
- Material: Chrome-vanadium steel
- Surface: Chrome-plated, polished
- Geometry: Box ends offset 18°

Packing & Sold in: Each

Item #	⊘ (mm)	L (mm)	a1 (mm)	a2 (mm)	dia. d1 (mm)	dia. d2 (mm)	h (mm)
WR0713305067	6x7	174	5.4	5.9	10.8	12.2	21
WR0713305089	8x9	187	6.4	6.9	13.2	14.7	23
WR0713305080	8x10	188	6.9	7.9		16.3	
WR0713305101	10x11	194	7.4	7.9	16.3	17.4	23.5
WR0713305103	10x13	215	7.9	9.9	16.3	20.7	24.5
WR0713305123	12x13	217	8.4	9.5	19.0	20.7	25
WR0713305137	13x17	243	9.9	11.8	20.7	26.2	27.5
WR0713305145	14x15	227		10.3	22.1	23.4	
WR0713305167	16x17	247	10.8	11.3	25.4	26.2	28
WR0713305168	16x18	250	11.3	11.8	25.6	28.2	
WR0713305179	17x19	284			28.0	29.4	29.5
WR0713305189	18x19		30				
WR0713305202	20x22	296	11.8	12.8	31.2	33.1	31
WR0713305213	21x23	312	12.3		32.1	35.5	
WR0713305224	22x24	313	12.8	14.3	37.0	37.0	34
WR0713305246	24x26	328		13.8		39.0	
WR0713305247	24x27	329		14.3	41.0		
WR0713305258	25x28	339	13.8	14.8	37.8	42.0	37
WR0713305279	27x29	342	14.8	15.8	41.0	44.3	36.3
WR0713305302	30x32	359			45.0	48.2	39
WR0713305304	30x34	397	15.8	16.7	45.3	51.2	

ZEBRA POWERDRIV® (12-POINT) DOUBLE BOX END WRENCH SETS - DEEP OFFSET



- Drive: **POWERDRIV®** (12-point)
- Material: Chrome-vanadium steel
- Surface: Chrome-plated, polished
- Geometry: Box end offset 18°

Packing & Sold in: Each



Item # WR071330540

Metric, DIN 838/ISO 3318, 8 pieces

- Sizes (in mm) 6x7, 8x9, 10x11, 12x13, 14x15, 16x17, 18x19, 20x22

Item # WR071330541

Metric, DIN 838/ISO 3318, 10 pieces

- Sizes (in mm) 8x9, 10x11, 12x13, 14x15, 16x17, 18x19, 20x22, 21x23, 24x27, 30x32

Item # WR071330542

Metric, DIN 838/ISO 3318, 12 pieces

- Sizes (in mm) 6x7, 8x9, 10x11, 12x13, 14x15, 16x17, 18x19, 20x22, 21x23, 24x27, 25x28, 30x32

ZEBRA POWERDRIV® (12-POINT) DOUBLE BOX END RATCHET WRENCH - 4-IN-1



Metric, straight

- Output: Double box end **POWERDRIV®** (12-point)
- Finely toothed, 72 teeth
- Single-handed operation via reversing lever for clockwise and counterclockwise rotation
- Material: Chrome-vanadium steel
- Basic body surface: chrome-plated, high-gloss polished
- Geometry: Straight box end

4 sizes in one ratchet wrench

- Most common wrench sizes are covered by only 2 ratchet wrench

1/4" bit adapter available

- Simply insert into size 10 mm ratchet wrench to use as a bit ratchet

For hard-to-access areas

- Narrow ratchet head
- Packing & Sold in: Each

Item #	(mm)							
		L (mm)	a1 (mm)	a2 (mm)	b1 (mm)	b2 (mm)	d1 (mm)	d2 (mm)
WR0714257013	8x10 + 12x13	150	7.3	8.6	13.8	16.8	20.2	24.8
WR0714257017	10x19 + 13x17	200	9.0	11.2	17.1	21.9	27.2	33.6
WR0714257019	16x17 + 18x19	230	10.3		20.2		31.5	33.5

ZEBRA POWERDRIV® (12-POINT) DOUBLE BOX END RATCHET WRENCH SET 4-IN-1 (3 PIECES)



Innovative double-sided, double-ended ratcheting wrench.

- Drive: Double-box end **POWERDRIV®** 12-point, fine-toothed, 72 teeth, one-hand operation via reversing lever for clockwise and counterclockwise use
- Material: Chrome-vanadium steel
- Surface: Chrome-plated, high gloss polish
- Geometry: box end straight
- Four sizes per ratchet wrench; the most common sizes are covered by only two ratchet wrenches
- 1/4" bit adapter available: simply insert in size 10 mm ratchet wrench, can then be used as a bit ratchet
- Narrow ratchet head for hard-to-reach areas

Packing & Sold in: Each

5° angle of rotation for working in the tightest of spaces. Precision-machined ring core for smooth and secure use.

Item #	Set (comes in a clear plastic blister pack)	(mm)	Finish
WR071425730	3 pieces	8 x 10 + 12 x 13, 16 x 17 + 18 x 19 Bit adapter: 10 mm 1/4", 20 mm long	Chrome
WR0714257300	3 pieces	8 x 10 + 12 x 13, 16 x 17 + 18 x 19 Bit adapter: 10 mm 1/4", 20 mm long	Black Chromium

ZEBRA DOUBLE OPEN-ENDED WRENCH ASSORTMENT - METRIC



Item # **WR0965900404**

8 Pieces

Contents:

Size (in mm)

- 6 x 7, 8 x 9, 10 x 11, 12 x 13, 14 x 15, 16 x 17, 18 x 19, 20 x 22
- Includes foam insert

ZEBRA COMBINATION WRENCH ASSORTMENT - METRIC



Item # **WR0965900403**

11 Pieces

Contents:

Size (in mm)

- 8, 9, 10, 11, 12, 13, 14, 15, 17, 19, 22
- Includes foam insert

ZEBRA COMBINATION WRENCH ASSORTMENT - METRIC

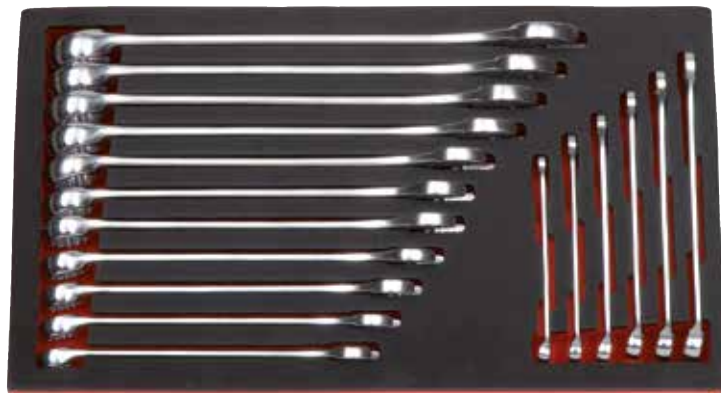

Item # **WR0965900401**

17 Pieces

Contents:

Size (in mm)

- 6, 7, 8, 9, 10, 11, 12, 13, 14, 15, 16, 17, 18, 19, 20, 21, 22
- Includes foam insert

WRENCHES
ALLEN KEYS
RIVETERS
SCREWDRIVERS
T-HANDLES
BITS
RATCHETS



ZEBRA
0613 430 214

1/4" 215mm

1/2" 125mm

21

22

24

26

15

16

17

18

14

13

12

11

10

9

8

7

6

5

4

3

2

1

ZEBRA ALLEN KEYS

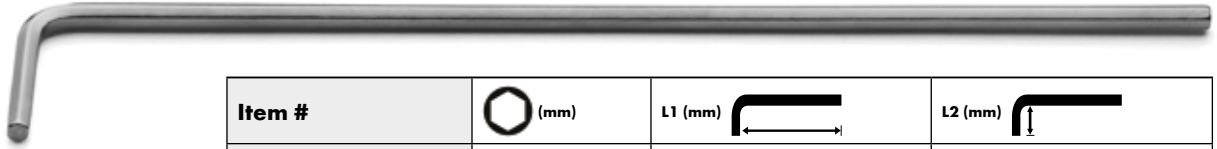

Long version

- Bright nickel-plated
 - Chamfered front edges
- Packing & Sold In: Each



Item #	⊙ (mm)	L1 (mm)	L2 (mm)
WR07153118	2.5	115	21
WR07153119	3.0	129	23
WR07153120	4.0	144	29
WR07153121	5.0	165	33
WR07153122	6.0	186	38
WR07153123	7.0	197	41
WR07153124	8.0	208	44
WR07153125	9.0	219	47
WR07153126	10.0	234	50
WR07153127	11.0	238	53
WR07153128	12.0	262	57
WR07153129	14.0	294	70
WR07153130	17.0	337	80

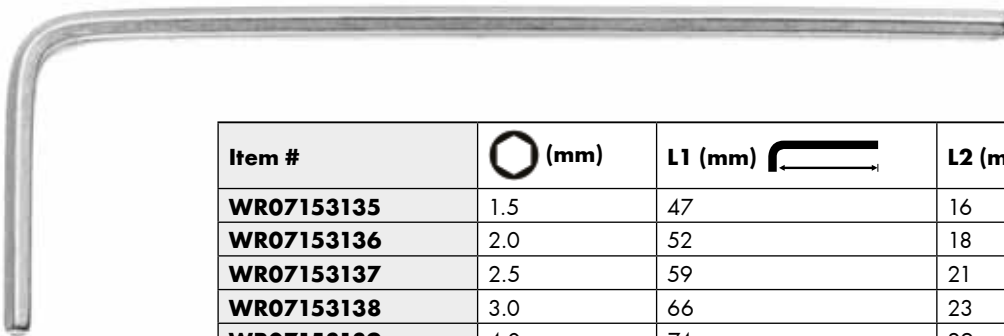

Short version

- Bright nickel-plated
 - Chamfered front edges
- Packing & Sold In: Each



Item #	⊙ (mm)	L1 (mm)	L2 (mm)
WR07153135	1.5	47	16
WR07153136	2.0	52	18
WR07153137	2.5	59	21
WR07153138	3.0	66	23
WR07153139	4.0	74	29
WR071531391	4.5	80	31
WR07153140	5.0	85	33
WR071531401	5.5	90	35
WR07153141	6.0	96	38
WR07153142	7.0	102	41
WR07153143	8.0	108	44
WR07153144	9.0	114	47
WR07153146	11.0	129	53
WR07153147	12.0	137	57
WR07153148	14.0	154	70
WR071531481	16.0	168	73
WR07153149	17.0	177	80
WR07153150	19.0	199	89
WR07153151	22.0	222	102

WRENCHES
ALLEN KEYS
RIVETERS
SCREWDRIVERS
T-HANDLES
BITS
RATCHETS

ZEBRA ALLEN KEY ASSORTMENTS



9 pieces, in plastic holder, short version

- Bright nickel-plated
- Chamfered front edges

Item #	Set	Contents (mm)
WR071531100	9-pcs	1.5, 2, 2.5, 3, 4, 5, 6, 8, 10

10 pieces, in plastic holder, short version

- Bright nickel-plated
- Chamfered front edges

Item #	Set	Contents (mm)
WR071531110	10-pcs	1.5, 2, 2.5, 3, 4, 5, 6, 8, 10, 12

9 pieces, in plastic holder, long version

- Bright nickel-plated
- Chamfered front edges

Item #	Set	Contents (mm)
WR071531120	9-pcs	1.5, 2, 2.5, 3, 4, 5, 6, 8, 10



ZEBRA TORX ALLEY KEY ASSORTMENT



8 pieces, in plastic holder

- TX socket
- Round blade
- Bright nickel-plated

Item #	Set	Contents
WR071536100	8-pcs	TX 9, 10, 15, 20, 25, 27, 30, 40

ZEBRA HAND HELD RIVET PLIERS WITH LONG NOSE PIECE FOR INSTALLING BLIND RIVETS



Item # WR091511

Universal, hand-held steel riveting pliers with exchangeable mouth pieces for the installation of commercial rivets made of aluminum, copper, steel and stainless steel

Features

- With long nose piece for installing aluminum, copper, steel and stainless steel blind rivets: \varnothing 3.2 mm, 4 mm, 4.8 mm
- Length of nose piece: 52 mm
- Diameter nose piece adapter: 19 mm

Technical data

Length, nose piece mounting (including nose piece)	52mm
Diameter, nose piece mounting	19mm



HAND HELD RIVETER FOR INSTALLING BLIND RIVETS

Item # WR094915

Hand-held riveter for installing blind rivets \varnothing 2.4 mm, 3 mm and 4 mm made of aluminum, copper, steel and stainless steel and blind rivets \varnothing 5 mm made of aluminum

Technical data

Length, nose piece mounting (including nose piece)	260mm
--	-------



ZEBRA PISTOL GRIP RATCHET SCREWDRIVER WITH 6 BIT MAGAZINE (BITS NOT INCLUDED)



High-performance ratchet screwdriver

- High-performance ratchet screwdriver
- 3-position adjustment wheel, adjustable with one hand, easy to change direction while working without using the other hand
- Magnet ensures a secure grip on bits and screws
- 45 teeth, max. torque of up to 40 Nm
- 2K grip for optimum ergonomic work
- Can be used as a standard screwdriver in the straight position or as a pistol grip in the 60° position thanks to the adjustable handle LED technology
- Working area is always well lit, lights the screw directly
- Especially suitable for dark areas
- Blade: Short bit holder blade with magnet, brushed chrome-plated
- Output: DIN 3126-D 6.3
- Sealing cap with bit magazine for a total of 6 bits (bits not included)

Packing & Sold In: Each

Item #	Designation	Length (mm)
1/4" Bits		
WR0613714	Telesc. magn. holding	150 - 530 mm

Item #	(in.)	A1 (mm)	A2 (mm)	A3 (mm)	B (mm)	C (mm)	D (mm)
WR06136400	1/4"	10	37	40	25	26	113

ZEBRA 3K HEX BLADE PHILLIPS HEAD SCREWDRIVER



Flexible 3K handle ensures perfect ergonomics, force transmission and working comfort

Screwdriver, Phillips Head

- Blade: One-piece hexagon blade, brushed chrome-plated; wrench adapter matte nickel-plated, tempered, impact-resistant
 - Würth color coding system
 - Large impact cap
 - Tip: DIN 5260-PH, ISO 8764-PH with black point tip
- Packing & Sold In: Each

Item #					
		A (mm)	B/C (mm)		
WR06132011	PH 1	80	96/31	5/8	3 1/8"
WR06132012	PH 2	100	106/35	6/10	4"
WR06132013	PH 3	150	114/38	8/13	6"

ZEBRA 3K HEXAGON BLADE SLOTTED HEAD SCREWDRIVER

Flexible 3K handle ensures perfect ergonomics, force transmission and working comfort.



Screwdriver, flat slotted

- Blade: One-piece hexagon blade, brushed chrome-plated; torque adjustment matte nickel-plated, tempered, impact-resistant
- Large impact cap
- Output: DIN 5264-A, ISO 2380 with black point tip

Packing & Sold In: Each

Item #	 A (mm) B (mm)	 A (mm) B/C (mm)		 (mm)	 A (in.)
		A (mm)	B/C (mm)		
WR0613200035	0.6 x 3.5	80	83/27	4/-	1/8 x 3 1/16"
WR0613200045	0.8 x 4.5	90	96/31	5/8	3/16 x 3 3/5"
WR0613200055	1.0 x 5.5	100	96/31	6/10	7/32 x 4"
WR061320007	1.2 x 7.0	125	106/35	6/10	9/32 x 5"
WR061320009	1.6 x 9.0	150	114/38	8/13	11/32 x 6"
WR061320010	1.6 x 10.0	175	114/38	8/13	3/8 x 7"
WR061320012	2.0 x 12.0	200	114/38	10/16	1/2 x 8"

ZEBRA 3K SLOTTED AND PHILLIPS HEAD SCREWDRIVER SET - 5 PIECES



5 pieces, with three slotted and two Phillips head screwdrivers for the automotive and metalwork trades

- Flexible 3K handle ensures perfect ergonomics, power transmission and working comfort
- Impact caps

Packing & Sold In: Each

Item #	Contents		
WR06139015	5-pc. set	1.0x5.5 / 1.2x7.0 / 1.6x9.0 mm	PH 1 PH 2



ZEBRA® 3K HANDLE

The flexible 3-component handle ensures an optimal, sensitive seat in the hand and allows connection with the robust design also the highest power transmission.

ZEBRA 3K TORX SCREWDRIVER SET (6 PIECES)



Item # **WR06139036** 6 piece set



6 pieces, with flexible 3K handle for perfect ergonomics, power transmission and operating comfort

- Blade: Round, brushed chrome-plated
- Tip: TX socket with black point tip
- Würth color coding system
- Screw symbol printed on handle end for quick identification

Packing & Sold In: Each

			 (in.)
	A (mm)	B/C (mm)	
TX 8	60	83/27	2 3/8"
TX 10	80	96/31	3 1/8"
TX 15			
TX 20	100	106/35	4"
TX 25			
TX 30	115		4 9/16"

ZEBRA SLOTTED SCREWDRIVER - ROUND BLADE



Round blade

- Blade: Matte chrome-plated
- Tip: DIN 5264-A, ISO 2380, black point tip
- Standard: DIN 5265

Packing & Sold In: Each

Item #				 (in.)
		A (mm)	B/C (mm)	
WR061323103	0.5 x 3.0	80	73/20	1/8" x 3 1/8"
WR0613231065	1.2 x 6.5	150	106/35	1/4" x 6"
WR061323110	1.6 x 10.0	200	114/38	3/8" x 8"

ZEBRA SLOTTED SCREWDRIVER - ROUND BLADE, SHORT



Round blade, short

- Blade: Matte chrome-plated
- Tip: DIN 5264-A, ISO 2380, black point tip
- Standard: DIN 5265

Packing & Sold In: Each

Item #				 (in.)
		A (mm)	B/C (mm)	
WR061325108	1.2 x 8.0	25	62/31	5/16 x 1"

ZEBRA SLOTTED SCREWDRIVER - HEXAGON BLADE, IMPACT CAP, WRENCH ADAPTER



Hexagon blade, impact cap

- Large impact cap
- Tip: DIN 5264-A, ISO 2380, black point tip
- Wrench adapter

Packing & Sold In: Each

Item #	A (mm)	B/C (mm)	(mm)	(in.)
WR0613321045	0.8 x 4.5	90	5 / 8	3/16 x 3 3/5"
WR0613321055	1.0 x 5.5	96/31	6 / 10	7/32 x 4"
WR061332107	1.2 x 7.0	106/35		9/32 x 5"
WR061332109	1.6 x 9.0	114/38	8 / 13	11/32 x 6"
WR061332110	1.6 x 10.0			3/8 x 7"
WR061332112	2.0 x 12.0	120/40.5	10 / 16	1/2 x 8"
WR061332114	2.5 x 14.0			9/16 x 10"

ZEBRA SLOTTED SCREWDRIVER - HEXAGON BLADE, WRENCH ADAPTER



Hexagon blade and wrench adapter

- Blade: Matte chrome-plated
- Tip: DIN 5264-A, ISO 2380, black point tip

Packing & Sold In: Each

Item #	A (mm)	B/C (mm)	(mm)	(in.)
WR0613421035	0.6 x 3.5	80	4 / -	1/8 x 3 1/16"
WR0613421004	0.8 x 4.0	90	5 / 8	5/32 x 3 5/8"
WR0613421055	1.0 x 5.5	100		96/31
WR0613421065	1.2 x 6.5	125	6 / 10	1/4 x 5"
WR061342108	1.6 x 8.0	150	8 / 13	5/16 x 6"
WR061342110	1.6 x 10.0	175		114/38
WR061342112	2.0 x 12.0	200	10 / 16	1/2 x 8"

ZEBRA SLOTTED SCREWDRIVER - HEXAGON BLADE, LASER-CUT TIP



Laser-cut tip profile

Laser-cut blade tip for a sharp-edged surface structure



Laser-cut tip, hexagon blade

- Ultra-secure seating of screwdriver in screw head
- Better screw grip for improved torque transfer
- Less slippage means improved safety as well as less damage to screws and sensitive surfaces

- No repeated placement when screwing
 - Blade: Brushed chromium-plated
 - Tip: DIN 5264-A, ISO 2380, laser-cut tip, Black Point Tip
- Packing & Sold In: Each

Item #	A (mm)	B/C (mm)	(mm)	(in.)
WR0613424035	0.6 x 3.5	75	4 / -	1/8 x 3 1/16"
WR061342404	0.8 x 4.0	90	5 / 8	5/32 x 3 5/8"
WR0613424055	1.0 x 5.5	100		96/31
WR0613424065	1.2 x 6.5	125	6 / 10	1/4 x 5"
WR061342408	1.6 x 8.0	150	8 / 13	5/16 x 6"
WR061342410	1.6 x 10.0	175		114/38

ZEBRA PHILLIPS HEAD SCREWDRIVER - HEXAGON BLADE - IMPACT CAP - WRENCH ADAPTER



Hexagon blade, impact cap, wrench adapter

- Large impact cap
 - Tip: DIN 5260-PH, ISO 8764-PH, black point tip
 - Standard: DIN 5262, SMS SS 2831
- Packing & Sold In: Each

Item #	+			 (mm)	 (in.)
		A (mm)	B/C (mm)		
WR06133221	PH 1	80	96/31	5 / 8	3 1/8"
WR06133222	PH 2	100	106/35	6 / 10	4"
WR06133223	PH 3	150	114/38	8 / 13	6"
WR06133224	PH 4	200	120/40.5	10 / 16	8"

ZEBRA PHILLIPS HEAD SCREWDRIVER - ROUND BLADE - SHORT



Round blade, short

- Blade: Matte chrome-plated
 - Tip: DIN 5260-PH, ISO 8764-PH, black point tip
 - Standard: DIN 5262, SMS SS 2831
- Packing & Sold In: Each

Item #	+			 (in.)
		A (mm)	B/C (mm)	
WR06132521	PH 1	25	62/31	1 3/4"
WR06132522	PH 2			

ZEBRA PHILLIPS HEAD SCREWDRIVER - ROUND BLADE



Round blade

- Blade: Matte chrome-plated
 - Tip: DIN 5260-PH, ISO 8764-PH, black point tip
 - Standard: DIN 5262, SMS SS 2831
- Packing & Sold In: Each

Item #	+			 (in.)
		A (mm)	B/C (mm)	
WR061323201	PH 1	80	96/31	3 1/8"
WR061323202	PH 2	100	106/35	4"
WR061323203	PH 3	150	114/38	6"
WR061323204	PH 4	200	120/41	8"

ZEBRA PHILLIPS HEAD SCREWDRIVER - HEXAGON BLADE - WRENCH ADAPTER



Hexagon blade, wrench adapter

- Blade: Matte chrome-plated
 - Tip: DIN 5260-PH, ISO 8764-PH, black point tip
- Packing & Sold In: Each

Item #	PH 1 PH 2 PH 3 PH 4	A (mm) B/C (mm)		Hexagon (mm)	A (in.)
		A (mm)	B/C (mm)		
WR06134221	PH 1	80	96/31	5 / 8	3 1/8"
WR06134222	PH 2	100	106/35	6 / 10	4"
WR06134223	PH 3	150	114/38	8 / 13	6"
WR06134224	PH 4	200	120/40.5	10 / 16	8"

ZEBRA PHILLIPS HEAD SCREWDRIVER - LASER-CUT TIP - HEXAGON BLADE - WRENCH ADAPTER



Laser-cut tip, hexagon blade, wrench adapter

- Ultra-secure seating of screwdriver in screw head
- Better screw grip for improved torque transfer
- Less slippage means improved safety as well as less damage to screws and sensitive surfaces
- No repeated placement when screwing
- Blade: Brushed chrome-plated
- Tip: DIN 5260-PH, ISO 8764-PH, laser-cut tip, black point tip

Packing & Sold In: Each



Laser-cut tip profile
Laser-cut blade tip for a sharp-edged surface structure

Item #	PH 1 PH 2 PH 3	A (mm) B/C (mm)		Hexagon (mm)	A (in.)
		A (mm)	B/C (mm)		
WR06134251	PH 1	80	96/31	5 / 8	3 1/8"
WR06134252	PH 2	100	106/35	6 / 10	4"
WR06134253	PH 3	150	114/38	8 / 13	6"

ZEBRA TORX SCREWDRIVER - ROUND BLADE



- Blade: Round blade, matte chrome-plated
- Tip: TX socket, black point tip

Packing & Sold In: Each

Item #	PH 1 PH 2 PH 3	Blade Length (mm)
WR061343410	TX 10	80
WR061343415	TX 15	
WR061343420	TX 20	100
WR061343425	TX 25	
WR061343427	TX 27	115
WR061343430	TX 30	
WR061343440	TX 40	130
WR061343445	TX 45	

ZEBRA TORX SCREWDRIVER - ROUND BLADE - LONG LENGTH



- Blade: Round blade, matte chrome-plated
 - Tip: TX socket, black point tip
- Packing & Sold In: Each

Item #				 (in.)
		A (mm)	B/C (mm)	
WR061346410	TX 10	250	83/27	10"
WR061346420	TX 20		96/31	
WR061346430	TX 30		106/35	

ZEBRA SCREWDRIVER SET - ROUND BLADE - PHILLIPS/SLOTTED HEAD - 6 PIECES



Item # WR061392326 6 piece set



- 0.6 x 3.5 x 100 mm, 1.0 x 5.5 x 125 mm, 1.2 x 6.5 x 150 mm, 1.2 x 8.0 x 175, PH1, PH2
- Packing & Sold In: Each

(mm)	
0.6 x 3.5 x 100	PH 1
1.0 x 5.5 x 125	PH 2
1.2 x 6.5 x 150	
1.2 x 8.0 x 175	

ZEBRA SCREWDRIVER SET - HEXAGON BLADE - PHILLIPS/SLOTTED HEAD - WITH WRENCH ADAPTER- 6 PIECES



Includes:

Item # WR061394226 6 piece set



Hexagon blade and wrench adapter for automotive and metalwork trades

- Blade: Brushed chrome-plated
- 1 each of slotted screwdriver with hexagon blade and torque adjustment
- 0.6 x 3.5 x 75; 1.0 x 5.5 x 100; 1.2 x 6.5 x 125; 1.6 x 8.0 x 150
- 1 each of PH screwdriver with hexagon blade and torque adjustment PH 1; PH 2

Packing & Sold In: Each

Item #	(mm)	Item #	
WR0613421035	0.6 x 3.5 x 75	WR06134221	PH 1
WR0613421055	1.0 x 5.5 x 100	WR06134222	PH 2
WR0613421065	1.2 x 6.5 x 125		
WR061342108	1.6 x 8.0 x 150		

ZEBRA TORX SCREWDRIVER ASSORTMENT - 7 PIECES



- 7 Screwdrivers: TX 10; 15; 20; 25; 27; 30; 40
- Foam drawer insert



7 Piece Set

Item #: WR0965900502

ZEBRA TORX SCREWDRIVER SET - 8 PIECES



- 1 Screwdriver set TX 8 pcs.
- Blade: Round blade, brushed chromium-plated, tip: TX socket, black point tip



8 Piece Set

Item #: WR06139348

	Blade length (mm)
TX 10	80
TX 15	
TX 20	100
TX 25	
TX 27	115
TX 30	
TX 40	130
TX 45	

ZEBRA MULTI SCREWDRIVER ASSORTMENT - 8 PIECES



- 6 screwdrivers with one-piece hexagon blade 0.6 x 3.5; 0.8 x 4.5; 1.2 x 7.0; 1.6 x 9.0; PH1; PH2
- 2 screwdrivers, short, PH1; PH2
- Foam drawer insert

8 Piece Set

Item #: WR0965900501

ZEBRA SCREWDRIVER WITH 1/4" SQUARE TIP - INCLUDES RATCHET ADAPTER



One-piece blade

- Blade: Round, bright chrome-plated
 - Tip: DIN 3120-A 6.3
 - With ratchet adapter
- Packing & Sold In: Each



Item #	(in.)			(in.)
		A (mm)	B/C (mm)	
WR0613430310	1/4"	110	106/35	4 3/8"

ZEBRA SCREWDRIVER WITH 1/4" SQUARE TIP



Blade: Round, bright chrome-plated

- Tip: DIN 3126-D 6.3
- Packing & Sold In: Each

Item #	(in.)			(in.)
		A (mm)	B/C (mm)	
WR0613430311	1/4"	110	106/35	4 3/8"

ZEBRA SCREWDRIVER WITH 1/4 INCH BIT CHUCK



Blade: Round with magnet

- Head: Bright nickel-plated
 - Tip: DIN 3126-D 6.3
- Packing & Sold In: Each

Item #	(in.)			(in.)
		A (mm)	B/C (mm)	
WR061343031	1/4"	100	106/35	4"

ZEBRA SCREWDRIVER WITH 1/4 INCH BIT CHUCK



Flexible shaft

- Blade: Round, bright chrome-plated
 - Tip: DIN 3120-A 6.3
- Packing & Sold In: Each

Item #	(in.)			(in.)
		A (mm)	B/C (mm)	
WR06134733	1/4"	150	106/35	6"

ZEBRA RATCHET MAGAZINE SCREWDRIVER (INCLUDES 12 BITS)

Item # WR06136103



Equipped with 12 bits

- Blade: Circular blade with magnet, bright chrome-plated
- Tip: DIN 3126-D 6.3
- 28 teeth, max. torque over 20 Nm.
- Advantage of the ratchet function is no need to reposition

- hand. This enables fast, efficient operation in any assembly situation. Bit magazine for max. 12 bits
- Extendible, rotating magazine lets you find the bit you need quickly.
- 1/4" bit with color coding system

Packing & Sold In: Each

Designation	Tip
Included Bits	
PH 1	
PH 2	
TX 10	
TX 15	
TX 20	
TX 25	
TX 30	
Allen 4 mm	
Allen 5 mm	
Allen 6 mm	
Slotted, 0.6 x 4.5 mm	
1/4"	



Magnetic blade mount for 1/4" bits



Max. 12 bits

Easy removal of the desired bit



Secure closing thanks to "snap lock"

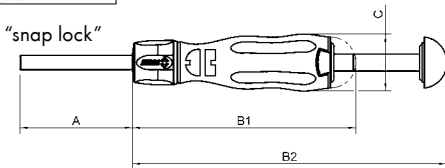

(in.)	A (mm)	B1/B2 (mm)	C (mm)
1/4"	80	147/207	37.5

ZEBRA MINI RATCHET SCREWDRIVER (INCLUDES 11 BITS)



10-piece bit strip + PH2 bit

- 2K handle
- Blade: Short bit holder blade with magnet, bright chrome-plated
- Tip: DIN 3126-D 6.3
- For high torque applications in tight spaces

Packing & Sold In: Each

Bits included (1 each):	
	1/4"
	5.5 mm
	4 mm, 5 mm
	PH 1, PH 2



Item #	(in.)				
		A (mm)	B (mm)	C (mm)	A2 (mm)
WR061363050	1/4"	26	70	38	20

ZEBRA T-HANDLE HEXAGON SOCKET WRENCH

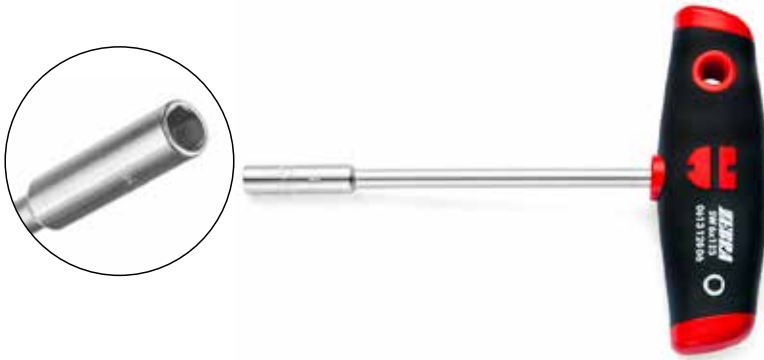

For hexagon head screws

- Blade: Round, chrome-plated
 - Tip: DIN 475/2
 - Inner bore for protruding threaded shafts
 - Standard: DIN 3125
- Packing & Sold In: Each

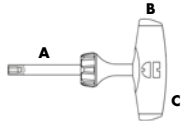
Item #	 (mm)				
		A (mm)	B/C (mm)	A (in.)	
WR061312010	10	125	35/104	5"	
WR061312013	13				
WR061312016	16				
WR061312017	17		39/117		
WR061312108	8	200	35/104	8"	
WR061312110	10	230		9 3/16"	
WR061312113	13				
WR061312208	8	300		35/104	12"
WR061312210	10				
WR061312213	13				

ZEBRA T-HANDLE SOCKET WRENCH SET (5 PIECES)

Item # WR061391205 5 piece set



- Blade: Circular, nickel-plated
 - Output: DIN 475/2
 - Inner bore for protruding threaded shafts
 - Standard: DIN 3125
- Packing & Sold In: Each

Includes:

Item #	 (mm)	Blade Length (mm)
Only available in set	6	125
WR061312007	7	
WR061312008	8	
WR061312010	10	
WR061312013	13	

ZEBRA T-HANDLE BALL HEAD TIP SCREWDRIVER WITH SIDE HEXAGON TIP

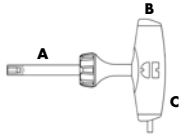
Item #	(mm)				Tip
		A (mm/in.)	B/C (mm)	Length of Side Hex Tip (mm)	
WR061313005	5	150/6"	35/105	17	Ball Head Tip
WR061313006	6				
WR061313008	8				
WR061313105	5	200/8"	39/117	22	
WR061313106	6				
WR061313108	8				
WR061313110	10				



Features:

- Integrated side tip
 - High-quality blade
 - One-piece blade
 - Multi-component handle comprising solid core and soft casing
 - Black point tip
- Packing & Sold In: Each

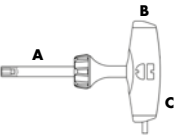

Item #	(mm)				Tip
		A (mm/in.)	B/C (mm)	Length of Side Hex Tip (mm)	
WR0613132025	2.5	150/6"	27/82	13	Hex Head Tip
WR061313203	3				
WR061313204	4		35/105	17	
WR061313205	5				
WR061313206	6				
WR061313208	8				
WR061313303	3	200/8"	27/82	13	
WR061313304	4				
WR061313305	5		35/105	17	
WR061313306	6				
WR061313308	8				
WR061313310	10				



ZEBRA T-HANDLE HEX BLADE SCREWDRIVER SET (6 PIECES)

Item # **WR061391306** 6 piece set



- 1 each of T-handle wrench with ball head hexagon socket, size 5 mm, 6 mm, 8 mm
 - 1 each of T-handle wrench with hexagon socket, size 2.5 mm, 3 mm, 4 mm
- Packing & Sold In: Each

Includes:

Item #	 Contents (mm)	Blade Length (mm)	Tip
WR0613132025	2.5	150	Hex Head Tip
WR061313203	3		
WR061313204	4		
WR061313005	5		
WR061313006	6		Ball Head Tip
WR061313008	8		



ZEBRA T-HANDLE TORX HEAD SCREWDRIVER WITH SIDE HEX TIP



Integrated side tip

- Effortless tightening and loosening of screw connections
- Particularly suitable for rusted and seized screw connections

High-quality blade

- Matte chrome-plated hexagon blade for optimal corrosion protection and long service life
- High-quality special steel ensures optimal balance of ductility and wear resistance

One-piece blade

- Resistant even to extremely high stresses

Multi-component handle comprising solid core and soft casing

- Highly slip-proof special black plastic ensures maximum torque transfer
- Solid core and soft casing ensure rigidity and a secure grip
- Ergonomically adapted handle for a comfortable grip and fatigue-free operation
- Integrated drilled hole for storage on tool rack

Black point tip

- Higher torque and a precise fit

Output: For TX socket

Packing & Sold In: Each

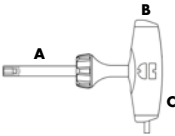
Item #	 (mm)			
		A (mm/in.)	B/C (mm)	Length of Side Hex Tip (mm)
WR061314009	TX 9	100/4"	27/82	13"
WR061314010	TX 10			
WR061314015	TX 15			
WR061314020	TX 20	200/8"	35/105	17"
WR061314025	TX 25			
WR061314027	TX 27			
WR061314030	TX 30			
WR061314040	TX 40			
WR061314045	TX 45			

ZEBRA T-HANDLE TORX SOCKET SCREWDRIVER SET (6 PIECES)

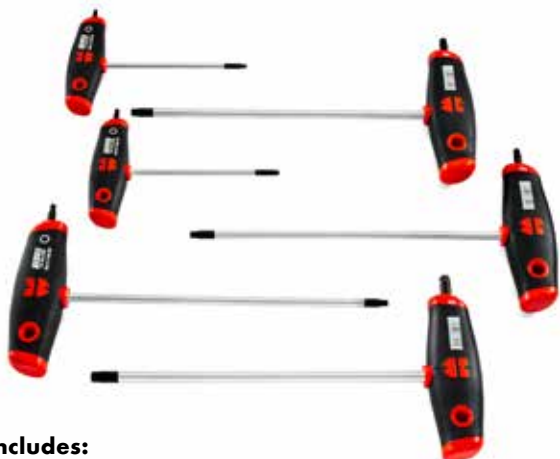

Item # WR061391406 6 piece set



For TX socket, with side output

Integrated side tip

- Effortless tightening and loosening of screw connections

High-quality blade

- Matte chrome-plated hexagon blade for optimal corrosion protection and long service life

Multi-component handle comprising solid core and soft casing

- Highly slip-proof special black plastic ensures maximum torque transfer
- Integrated drilled hole for storage on tool rack.

Contents: 6 pcs.

- 6 T-handle screwdrivers for TX socket (TX 10, 15, 20, 25, 30, 40)

Packing & Sold In: Each

Includes:

Item #		Blade Length (mm)
WR061314010	TX 10	100
WR061314015	TX 15	
WR061314020	TX 20	200
WR061314025	TX 25	
WR061314030	TX 30	
WR061314040	TX 40	

ZEBRA T-HANDLE, TORX SOCKET SET - IN SHEET STEEL RACK - 7 PIECES

Item # **WR06139147** 7 piece set

WRENCHES

ALLEN KEYS

RIVETERS

SCREWDRIVERS

T-HANDLES

BITS

RATCHETS



Includes:

Item #	⬠ (mm)	Blade Length (mm)
WR061314010	TX 10	100
WR061314015	TX 15	
WR061314020	TX 20	200
WR061314025	TX 25	
WR061314030	TX 30	
WR061314040	TX 40	
WR061314045	TX 45	



In sheet steel rack

Integrated side output

- Effortless tightening and loosening of screw connections
- Particularly suitable for rusted and seized screw connections

Multi-component handle comprising solid core and soft casing

- Ergonomically adapted handle for a comfortable grip and effortless work
- Integrated drilled hole for storage on tool rack

Black Point tip

- Higher torque and a precise fit

One-piece blade

- Resistant even to extremely high stresses

Contents: 7 pieces

- 1 each of T-handle screwdriver TX 10; TX 15; TX 20; TX 25; TX 30; TX 40; TX 45

Packing & Sold In: Each

ZEBRA T-HANDLE RATCHET SCREWDRIVER SET WITH 11 PIECE BITS

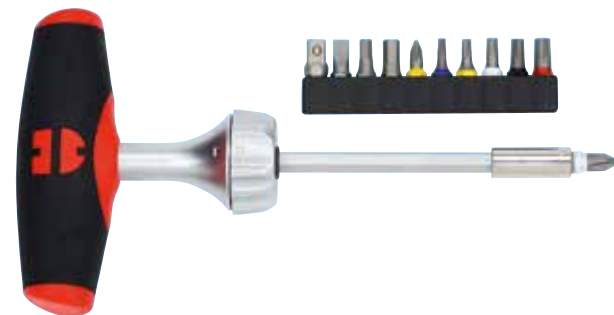

With 10-piece bit strip + PH2 bit

Robust ratchet function with 45 teeth

- Max. torque of up to 40 Nm
- 3-position adjustment wheel is adjustable with one hand
- Easy, one-handed change of direction while working

Packing & Sold In: Each

Bits included (1 each):	
	1/4"
	5.5 mm
	4 mm, 5 mm
	PH 1, PH 2



Ratchet function
Very rugged design, max. torque up to 40 Nm (29.5 lb-ft).

Item #	⬠ (in.)				
		A (mm)	B (mm)	C (mm)	A2 (mm)
WR061363040	1/4"	95	85	100	10

ZEBRA FLEXIBLE BIT HOLDER LENGTH 175MM - 1/4" DRIVE



Item #	Drive (in.)	Drive Type	Tip Size (in.)	Tip Type	Length (mm)
WR0613713	1/4"	Outer Hexagon	1/4"	Internal Hexagon Socket	175

RATCHET BIT ASSORTMENT - 38 PIECES



Bit set especially for automobiles and commercial vehicles, 38 pieces

- ZEBRA ratchet for 10 mm bits
- Additional ZEBRA adapter allows use of a 1/2" ratchet
- Supplied in a metal box with high quality interior foam compartment with clamping effect

Packing & Sold In: Each; Replacement bits sold in multiples of 5 each

Includes:

Item #	Destination	Drive	Length
WR071412100	ZEBRA Ratchet for 10mm bits		175mm
WR07151303	ZEBRA Adapter for 1/2" ratchet		37mm
WR061478820	TX 20 with hole		30mm
WR061478825	TX 25 with hole		
WR061478827	TX 27 with hole		
WR061478830	TX 30 with hole		
WR061478840	TX 40 with hole		
WR061478845	TX 45 with hole		
WR061478850	TX 50 with hole		
WR061478855	TX 55 with hole		75mm
WR0614788120	TX 20		
WR0614788125	TX 25		
WR0614788127	TX 27		
WR0614788130	TX 30		
WR0614788140	TX 40		
WR0614788145	TX 45		
WR0614788150	TX 50		
WR0614788155	TX 55		

Item #	Description
WR096512370	Ratchet Bit Set

Item #	Destination	Drive	Length
WR0614788240	TX 40		120 mm
WR0614788245	TX 45		
WR0614788250	TX 50		
WR0614788305	Hexagon socket M5		30 mm
WR0614788306	Hexagon socket M6		
WR0614788307	Hexagon socket M7		
WR0614788308	Hexagon socket M8		
WR0614788310	Hexagon socket M10		
WR0614788312	Hexagon socket M12		
Only Available in Set	Triple Square M5		
WR0614788406	Triple Square M6		
WR0614788408	Triple Square M8		
WR0614788410	Triple Square M10		
WR0614788412	Triple Square M12		75 mm
Only Available in Set	Triple Square M6		
WR0614788508	Triple Square M8		
WR0614788510	Triple Square M10		
Only Available in Set	Triple Square M12		
WR0614788902	PH 2		30 mm
WR0614788903	PH 3		

- 1 Ratchet with short 10 mm bit
- 2 1/2" ratchet with adapter

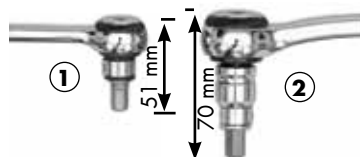

1/4 INCH PHILLIPS BIT (HEX QUICK CHANGE)

Packing & Sold In: Each



Item #	Designation	Phillips-Head System	Tip	Drive	Length (mm)
WR0614100201	PH 2	MSVM 2 - Magazine attachment - Makita		1/4"	152
WR0614100111		MSVW 1 - Magazine attachment - Wurth / Bosch			155
WR0614100211		MSVW 2 - Magazine attachment - Wurth / Bosch			168
WR0614100212		S50-TB - Magazine screw attachment - Wurth/Kress/Eibenstock			176.5

POWERDRIV HEX BIT - 3MM, 1/4 INCH DRIVE, 25MM LENGTH



POWERDRIV® bits allow force to be distributed across the curved surfaces on each side of the hexagon.

Packing & Sold In: Each; Multiples of 5

Item #	Tip size (mm)	Tip type	Drive	Length (mm)
WR061417693	3		1/4"	25
WR061417694	4			
WR061417695	5			
WR061417696	6			

1/4 INCH MAGNETIC BIT HOLDER (HEX QUICK CHANGE) - 75MM LENGTH



Quick-change chuck and permanent magnet

- Super-fast tool change: pushing the clamping collar forward releases the latch mechanism

Packing & Sold In: Each

Item #	Designation	Tip	Drive	Length (mm)
WR614176708	Multi-purpose holder	1/4"	1/4"	75

1/4 INCH NON-MAGNETIC BIT HOLDER (HEX QUICK CHANGE) - 51MM LENGTH



Quick-change chuck

- Quick-change chuck
- Non-magnetic holder for screwing in metallic environments
- Super-fast tool change: pushing the clamping collar forward releases the latch mechanism

Packing & Sold In: Each

Item #	Designation	Tip	Drive	Length (mm)
WR0614176711	Multi-purpose holder	1/4"	1/4"	51

ZEBRA UNIVERSAL BIT ASSORTMENT (105 PIECES)



Item # **WR0614250300** 105 piece set



Comprehensive 1/4" bit assortment with the most common standard and security bits in short and long versions

- A majority of the bits are for security screws. Used wherever unauthorized loosening is to be prevented
- Includes two bit adapters and one screw hook
- The solution for virtually all screw types
- In sturdy metal box with foam insert

Areas of Application:

Public facilities, motor vehicle and motorcycle sector, plumbing applications, construction industry, electrical, electronics and machine sector

SOCKETS

PLIERS / CUTTERS

Designation	Tip	Length	Qty.
AW [®]	10	25 mm	1
AW [®]	20		2
AW [®]	25		1
AW [®]	30		
AW [®]	40		
Slotted	0.6 x 4.5 mm		
Slotted	0.8 x 5.5 mm		
Slotted	1.2 x 6.5 mm		
Slotted	1.2 x 8 mm		
PH	0		2
PH	1		
PH	2		
PH	3		1
PZ	0		
PZ	1		
PZ	2		2
PZ	3		
PZ	3		
TX	8	1	
TX	10		
TX	15		
TX	20		
TX	25		
TX	27		
TX	30		
TX	40		
TX	45		
Allen Head	2 mm		25 mm
Allen Head	2.5 mm		
Allen Head	3 mm		
Allen Head	4 mm		
Allen Head	5 mm		
Allen Head	6 mm		
Allen Head	1/4"		
Allen Head	7 mm		
TX with hole	8		

Designation	Tip	Length	Qty.	
TX with hole	10	25 mm	1	
TX with hole	20			
TX with hole	25			
TX with hole	27			
TX with hole	30			
TX with hole	40			
TX with hole	45			
Claw Wrench	4/6/8/10			4
Three-wing	1/2/3/4			
	6/8/10			3
XZN	M4/5/6/8	4		
Allen head in inches	1/8", 9/64" 5/32",			
	M5/6/7/8			
Allen head with hole	2/2.5/3/4 mm			
Allen head with hole	5/6/7 mm	3		
Square	1/2/3/4	4		
Clutch	3/32", 1/8", 5/32"	3		

ZEBRA RATCHET WITH ROTARY DISC REVERSE



Rotary disc reverse

Fine tooth rotary disc with 72 teeth; 5° angle of rotation

- Compact, narrow head
 - Simple changeover from clockwise to counterclockwise rotation
 - Chamfered square – easier removal of socket wrench inserts
 - Offset ratchet body for more hand freedom
- Packing & Sold In: Each

Item #	Description	Tip Size	Length (mm)
WR07120140	Ratchet with rotary disc reverse	1/4"	138
WR07120380		3/8"	175
WR07120120		1/2"	250

ZEBRA 1/4 INCH BALL-HEAD 3-IN-1 RATCHET



Multi-functional spherical ratchet with adjustable handle

Features:

- Drive: 6.3 - 1/4"
 - Standard: DIN 3122, ISO 3315
 - Head: 72 teeth, angle of rotation: 5°, joint can be rotated 270°
 - Handle: Two-component handle, straight or adjustable 90° as T-handle
- Packing & Sold In: Each

Item #	Length (mm)	Ratchet head height (mm)	Ratchet diameter (mm)
WR071201405	145	26.5	20



3 in 1!

Can be used like a conventional ratchet, as a screwdriver or a T-handle!



ZEBRA 1/4 INCH LEVER REVERSIBLE RATCHET, DUST PROTECTED

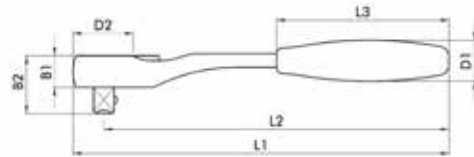

Dust-protected ratchet for a long service life even under difficult working conditions

- Standard: DIN 3122, ISO 3315
- Reversing lever for clockwise and counterclockwise rotation
- Geometry: Ratchet body with depressed center for more freedom of movement
- Material: Chrome-vanadium steel
- Grip Handle Material: 2-component plastic
- With 72 teeth, 5 ° angle of rotation

Packing & Sold In: Each

Item #	Tip Size	L1 (mm)	L2 (mm)	L3 (mm)	B1 (mm)	B2 (mm)	D1 (mm)	D2 (mm)
WR071201403	1/4"	136	125	61	13	22	16	21
WR071203803	3/8"	177	160	79	16	29	21	29
WR071201203	1/2"	253	240	115	19	36	26	38

ZEBRA 10 MM RATCHET TOOL

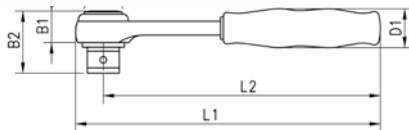

Features:

- Head: 72 teeth, swivel angle 5°, round, compact head
 - Shaft: Chrome-plated, high-grip 2-component handle
- Packing & Sold In: Each

Item #	Destination	Drive	L1 mm	L2 mm	B1 mm	B2 mm	D1 mm	D2 mm	Length
WR071412100	Ratchet for 10mm bits		175	160	19	33	26	20	175mm
WR07151303	Adapter for 1/2" ratchet								37mm

ZEBRA 1/2 INCH JOINTED HANDLE



Features:

- Standard: DIN 3122, ISO 3315
 - Joint: Rotatable through 180°, head can be used in any desired position
 - Flexible operation even in obstructed areas
 - Powerful breaking and tightening ability
 - Chrome-plated
- Packing & Sold In: Each

Item #	Length (mm)	Tip size (in.)	Handle diameter (mm)	Width of head (mm)
WR0712130102	490	1/2"	35	20

ZEBRA 1/4 INCH SOCKET BITS

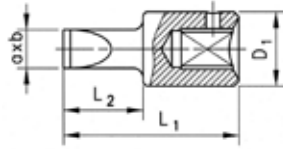

Socket Wrench, Slotted

- Surface: Chrome-plated, polished/matte
 - Drive: 1/4" square socket, ball catch groove
 - Tip: DIN 5264, slotted
- Packing & Sold In: Each

Item #	 A (mm) B	L1 (mm)	L2 (mm)	D1 (mm)
WR071511735	0.6 x 3.5	32	12	12
WR071511755	1.0 x 5.5			
WR071511765	1.2 x 6.5			
WR071511780	1.2 x 8.0			

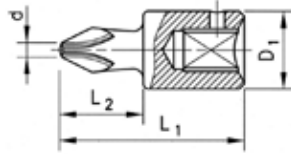

Socket Wrench, Phillips

- Surface: Chrome-plated, polished/matte
 - Drive: 1/4" square socket, ball catch groove
 - Tip: ISO 8764-PH
- Packing & Sold In: Each

Item #	 (mm)	L1 (mm)	L2 (mm)	D1 (mm)
WR071511801	PH 1	32	12	12
WR071511802	PH 2			
WR071511803	PH 3			

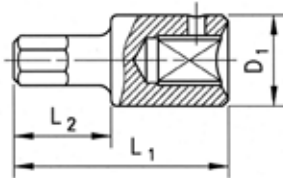

Socket Wrench, Hexagon

- Surface: Chrome-plated, polished/matte
 - Drive: 1/4" square drive, ball catch groove
 - Output: For hexagon socket, DIN 7422
- Packing & Sold In: Each

Item #	 (mm)	L1 (mm)	L2 (mm)	D1 (mm)
WR071511503	3	32	12	12
WR071511504	4			
WR071511505	5			
WR071511506	6			
WR071511507	7			
WR071511508	8			

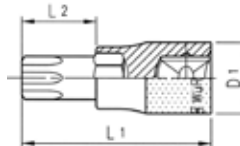

Socket Wrench, Torx

- Surface: Chrome-plated
 - Drive: 1/4" square socket, ball catch groove
 - Tip: For TX screws
- Packing & Sold In: Each

Item #	(mm)	L1 (mm)	L2 (mm)	D2 (mm)
WR071511310	2.72	10	32	12
WR071511315	3.26	15		
WR071511320	3.84	20		
WR071511325	4.40	25		
WR071511327	4.96	27		
WR071511330	5.49	30		
WR071511340	6.60	40		

WRENCHES

ALLEN KEYS

RIVETERS

SCREWDRIVERS

T-HANDLES

BITS

RATCHETS

ZEBRA 1/4 INCH EXTENSION

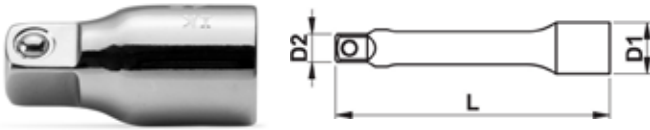

- Surface: Chrome-plated, polished
 - Drive: 1/4" square drive, ball catch groove
- Packing & Sold In: Each

Item #	Length (mm)	D1 (mm)	D2 (mm)
WR0713118101	25	12	8.3
WR0713118102	53		
WR0713118104	101		
WR0713118106	152		
WR0713118110	250		

ZEBRA 1/2 INCH ANGLED EXTENSION



Item # WR0712138100

For working in hard-to-reach places

- Standard: DIN 3123, ISO 3316
- Surface: Chrome-plated
- Drive: 1/2" square socket, ball catch groove
- Tip: 1/2" square head
- Length: 50 mm
- Angular movement of up to 8"
- Tip: 1/4" square head

Packing & Sold In: Each

ZEBRA 3/8 INCH EXTENSION



Item # WR0713128105

- Standard: DIN 3123, ISO 3316
- Surface: Chrome-plated
- Drive: 3/8" square socket, ball catch groove
- Tip: 3/8" square head
- Length: 125 mm

ZEBRA 1/2 INCH EXTENSION



- Standard: DIN 3123, ISO 3316
 - Surface: Chrome-plated
 - Drive: 1/2" square socket, ball catch groove
 - Tip: 1/2" square head
- Packing & Sold In: Each

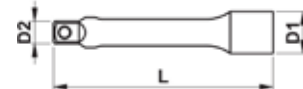

Item #	Length (mm)	D1 (mm)	D2 (mm)
WR0712138102	53	23	15
WR0712138103	75		
WR0712138105	125		
WR0712138110	250		17
WR0712138118	457		

ZEBRA 1/2 INCH POWERDRIV (12-POINT) SOCKET

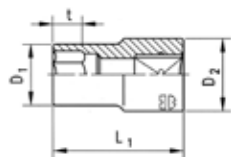

Metric, short

- Standard: DIN 3124, ISO 2725
- Surface: Chrome-plated, ground/matte
- Drive: 1/2" square socket, ball catch groove
- Tip: POWERDRIV®

Packing & Sold In: Each

Item #	(mm)	L1 (mm)	D1 (mm)	D2 (mm)	t (mm)
WR0712133108	8	36	12.9	21.9	7
WR0712133109	9		14		8
WR0712133110	10		15.4		10
WR0712133111	11		16.6		
WR0712133112	12		17.9		11
WR0712133113	13		19.1		
WR0712133114	14		20.4		
WR0712133115	15		21		
WR0712133116	16		22.5		16
WR0712133117	17		24		
WR0712133118	18	25.4	23.5		
WR0712133119	19	26.5	24.7	19	
WR0712133120	20	27.9	25.5		
WR0712133121	21	38	28.5	26	24
WR0712133122	22		29.9	26.5	
WR0712133123	23		31.2	27.7	
WR0712133124	24		32	29	
WR0712133126	26		35	31.5	
WR0712133127	27	44	36	32.2	25
WR0712133128	28		37.7	33.5	
WR0712133130	30		40	36	
WR0712133132	32		42	38.1	
WR0712133134	34	47	45.5	40	25
WR0712133136	36	50	48	42	28.5

ZEBRA 1/2 INCH SOCKET BITS - TORX

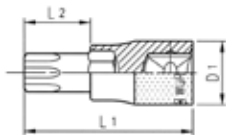
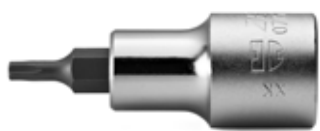

Torx, short

- Design: Short
- Surface: Chrome-plated
- Drive: 1/2" square socket, ball catch groove
- Tip: For TX screws

Packing & Sold In: Each

Item #	(mm)	L1 (mm)	L2 (mm)	D1 (mm)
WR071513320	20	60	20	22.5
WR071513325	25			
WR071513327	27			
WR071513330	30			
WR071513340	40			
WR071513345	45			
WR071513350	50			
WR071513355	55			
WR071513360	60			
WR071513370	70			
WR071513380	80	28		
WR0715133100	100	80	42	26

ZEBRA 1/2 INCH POWERDRIV (HEXAGON) SOCKET

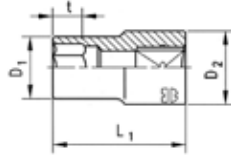

Metric, long

- Surface: Chrome-plated, polished/matte
 - Drive: 1/2" square socket, ball catch groove
 - Tip: **POWERDRIV®** (Hexagon)
- Packing & Sold In: Each

Item #	Hex (mm)	L1 (mm)	D1 (mm)	D2 (mm)	t (mm)
WR0712132310	10	77	15.4	21.8	25.0
WR0712132311	11		16.6		
WR0712132312	12		17.9		
WR0712132313	13		19.1		
WR0712132314	14		20.4		
WR0712132315	15		21.6	21.6	
WR0712132316	16		22.6	22.6	
WR0712132317	17		24.1	24.1	
WR0712132318	18		25.4	25.4	
WR0712132319	19		26.5	26.5	
WR0712132320	20	27.8	27.8	35.5	
WR0712132321	21	28.2	28.2		
WR0712132322	22	29.7	29.7		
WR0712132323	23	31.2	27.0		
WR0712132324	24	31.7			
WR0712132326	26	35.4	33.0		
WR0712132327	27	35.7			
WR0712132328	28	37.6	33		
WR0712132330	30	39.8			
WR0712132332	32	41.9		34	

ZEBRA 1/2 INCH TORX SOCKET BITS, LONG

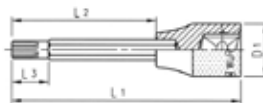

Torx, long

- Surface: Chrome-plated
 - Drive: 1/2" square socket, ball catch groove
 - Tip: For TX screws
- Packing & Sold In: Each

Item #	Hex (mm)	L1 (mm)	L2 (mm)	L3 (mm)	D1 (mm)
WR071513430	30	120	80	12.5	22.5
WR071513440	40				
WR071513445	45				
WR071513450	50	140	100	-	25
WR071513455	55				
WR071513460	60				
WR071513470	70				

ZEBRA 1/2 INCH SOCKET BITS

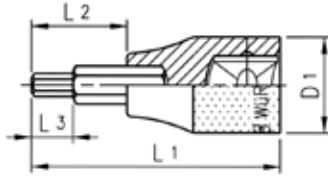

Hexagon

- Surface: Chrome-plated, polished/matte
- Drive: 1/2" square socket, all catch groove
- DIN 7422

Packing & Sold In: Each

Item #	(mm)	L1 (mm)	L2 (mm)	L3 (mm)	D1 (mm)			
WR0715137040	4	60	20	6	22.5			
WR0715137051	5			7.5				
WR0715137060	6			9				
WR0715137062	6	140	100	-				
WR071513707	7	60	20			10.5		
WR0715137080	8	140	100			-		
WR0715137082	8							
WR0715137100	10	60	20				-	
WR0715137102	10	140	100					
WR0715137120	12	60	20					-
WR0715137122	12	140	100					
WR071513714	14	60	20		25			
WR071513717	17				28			

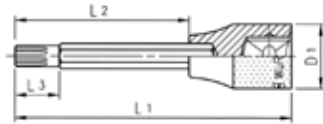

12-Point, Short

- Surface: Chrome-plated
- Drive: 1/2" square socket, ball catch groove

Packing & Sold In: Each

Item #	(mm)	L1 (mm)	L2 (mm)	L3 (mm)	D1 (mm)		
WR071513805	5	60	20	4	22.5		
WR071513806	6			5			
WR071513808	8	100	60	6			
WR0715138081	8						
WR071513810	10					20	
WR0715138101	10	100	60			-	
WR0715138121	12						
WR071513814	14	60	20				25
WR0715138160	16						28

ZEBRA 1/2 INCH HEXAGON SOCKET BIT, SHORT

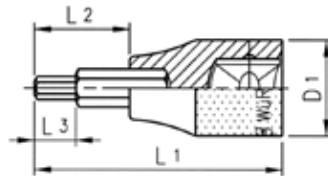

Standard

- Surface: Chrome-plated, polished/matte
- Drive: 1/2" square socket, ball catch groove

Packing & Sold In: Each

Item #	(in.)	L1 (mm)	L2 (mm)	L3 (mm)	D1 (mm)
WR071513751	7/32	60	20	8.34	22.5
WR071513752	1/4			9.53	
WR071513754	3/8			-	
WR071513756	1/2				

ZEBRA STEP-DOWN/UP SOCKETS

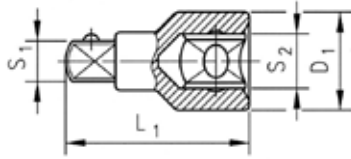

- Standard: DIN 3123, ISO 3316
- Surface: Chrome-plated, polished
- Material: Steel

Packing & Sold In: Each

Item #	■ S2 (in)	□ S1 (in)	L1 (mm)	D1 (mm)
WR0713118401	1/4"	3/8"	24	12.5
WR0713128401	3/8"	1/4"	27	17
WR0713128402		1/2"	36	20
WR0712138401	1/2"	3/8"	38	23
WR0712138402		3/4"	44	25
WR071514108	3/4"	1/2"	53.5	34

ZEBRA UNIVERSAL JOINTS



1/4"



3/8"



1/2"

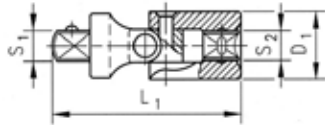

- Surface: Chrome-plated, polished
- Remains in specified position

Packing & Sold In: Each

Item #	■ S2 (in)	□ S1 (in)	L1 (mm)	D1 (mm)
WR0713118301	1/4"	1/4"	33	14
WR0713128301	3/8"	3/8"	55	17.5
WR0712138301	1/2"	1/2"	70	25



1/2 INCH IMPACT SOCKETS

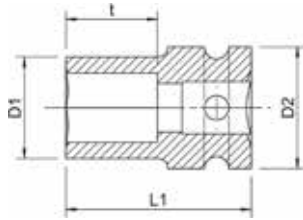

Metric, short

- For use with electric or pneumatic screwdrivers and impact tools
- Standard: DIN 3129, DIN 3121/ISO 1174
- Design: Forged, burnished
- Drive: Square socket 1/2"
- Tip: Hexagon

Packing & Sold In: Each

Item #	Hex (mm)	L1 (mm)	D1 (mm)	D2 (mm)	t (mm)	
WR07141302	9.5	38	17	25	12	
WR07141303	10		20		10	
WR07141304	12		21		12	
WR07141305	13		30	22.5	30	13.5
WR07141306	14			23		12
WR07141307	15			25		12.5
WR071413071	16			26		13.5
WR07141308	17			27.3		15
WR071413081	18			28.5		14
WR07141309	19			30		14.5
WR071413091	21	32		17		
WR07141310	22	34		20		
WR07141311	24	42		38		30
WR07141312	27		42	20		
WR07141330	30		44	21.5		
WR07141332	32		46	18.5		
WR07141334	34	48	49	30	18.5	
WR07141336	36		49		18.5	

Metric, long

- For use with electric or pneumatic screwdrivers and impact tools
- Standard: DIN 3129, DIN 3121/ISO 1174
- Design: Forged, burnished
- Drive: Square socket 1/2"
- Tip: Hexagon

Packing & Sold In: Each

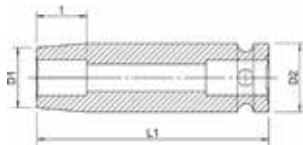

Item #	Hex (mm)	L1 (mm)	D1 (mm)	D2 (mm)	t (mm)	
WR07141313	13	78	20.5	30	17	
WR071413131	16		24		23	
WR07141314	17		26			
WR071413142	18		27.3			
WR07141315	19		28			
WR071413151	21		30			
WR07141316	22		32			
WR07141317	24		34			
WR07141318	27		38			30
			38			30

1/2 INCH IMPACT EXTENSIONS

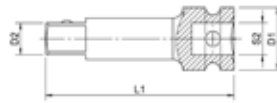

- For use with electric or pneumatic screwdrivers and impact tools
- Standard: DIN 3121/ISO 1174
- Design: Forged, burnished
- Drive: Square socket 1/2"
- Tip: External square drive 1/2", with ball lock

Packing & Sold In: Each

Item #	S2 (in)	L1 (mm)	D1 (mm)	D2 (in)
WR07141322	1/2"	75	25	1/2"
WR07141323	1/2"	150		1/2"

IMPACT STEP-UP SOCKET - 1/2 INCH TO 3/4 INCH

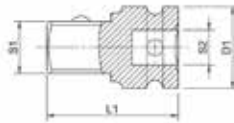

- For all electrical or compressed air-driven screwdrivers and impact tools
- Drop-forged steel guarantees high breaking and wear resistance
- Standard: DIN 3121/ISO 1174
- Design: Forged, burnished
- Drive: 1/2" square socket
- Tip: 3/4" square head

Packing & Sold In: Each

Item #	S2 (in)	S1 (in)	L1 (mm)	D1 (mm)
WR07141328	1/2"	3/4"	48	30

1/2 INCH IMPACT UNIVERSAL JOINT

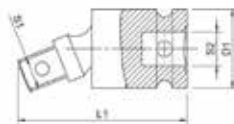

- For use with electric or pneumatic screwdrivers and impact tools
- Standard: DIN 3121/ISO 1174
- Design: Forged, burnished
- Drive: square socket 1/2"
- Tip: External square drive 1/2", with ball lock

Packing & Sold In: Each

Item #	S2 (in)	S1 (in)	L1 (mm)	D1 (mm)
WR0714138351	1/2"	1/2"	63	30

ZEBRA 1/4 INCH MULTI-SOCKETS



12-Point

- Surface: Chrome-plated, polished
- Drive: 1/4" square socket
- Tip: 12-point

Packing & Sold In: Each

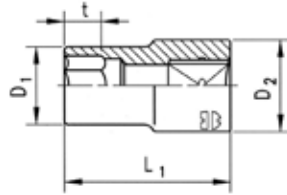

Item #	Multi-profile (mm)	Possible Uses				L1 (mm)	D1 (mm)	D2 (mm)	t (mm)
		Hexagon/bi-hexagon (mm)	Hexagon (in.)	TX Head TX	Square (mm)				
WR071311304	4	Size 4	5/32"	E 5	-	22	6.8	11.9	5
WR071311305	5	Size 5	-	-	Size 4		8.1		
WR0713113055	5.5	Size 5.5	7/32"	-	Size 4.5		8.7		
WR071311306	6	Size 6	-	E 8	Size 5		9.3		
WR071311307	7	Size 7	9/32"	-	-		10.8		
WR071311308	8	Size 8	5/16"	E 10	-		11.9	7	
WR071311309	9	Size 9	11/32"	-	-		13.4		13.4
WR071311310	10	Size 10	3/8"	E 12	Size 8		14.5	14.5	10
WR071311311	11	Size 11	7/16"	E 14	Size 9		15.9	15.9	
WR071311312	12	Size 12	15/32"	E 16	Size 10		16.9	16.9	
WR071311313	13	Size 13	1/2"	-	-		18.0	18.0	11
WR071311314	14	Size 14	9/16"	E 18	-		19.6	19.6	

WRENCHES
ALLEN KEYS
RIVETERS
SCREWDRIVERS
T-HANDLES
BITS
RATCHETS

ZEBRA 1/4 INCH MULTI-SOCKET ASSORTMENT (32 PIECES)



Item # **WR096511032** 32 piece set

The multiple profile is suitable for the five most common screw heads (hexagonal metric, square metric, bi-hex metric, hexagon inch, TX head)

- Supplied in a metal box with high-quality foam insert compartment with clamping effect
- 12 sockets
- 14 1/4" bits

Packing & Sold In: Each

Includes:

Item #	Description	Drive	Length
Only available in set	Reversing ratchet		138 mm
WR0713118104	Extension		100 mm
WR0713118106	Extension		150 mm
WR0713118301	Universal Joint		33 mm
WR0613430311	Screwdriver handle		216 mm
WR07151101	Adapter with quick change chuck		30 mm
WR071311304 Thru WR071311314	12 multi-use sockets, one each sizes 4-14	 	22 mm
WR0614176461	Bit PH 2		25 mm
WR061417693	Bit hex, socket size 3		
WR061417694	Bit hex, socket size 4		
WR061417696	Bit hex, socket size 6		
WR06143110	TX 10		Sold in multiple of 5 each 25 mm
Only available in set	TX 15		
WR06143120	TX 20		
WR06143125	TX 25		
WR06143127	TX 27		
WR06143130	TX 30		
WR06143140	TX 40		



Hexagonal metric



Bi-hexagonal metric



Hexagon inch



Square metric



External Torx



ZEBRA 3/8 INCH MULTI-SOCKETS

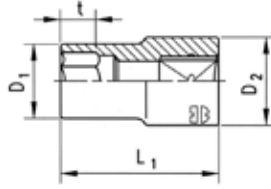

12-Point

- Surface: chrome-plated, polished
- Drive: 3/8" square socket
- Tip: 12-Point

Packing & Sold In: Each

Item #	Multi-profile (mm)	Possible Uses				L1 (mm)	D1 (mm)	D2 (mm)	t (mm)
		6-sd./12-sd. (mm)	6-sided (in.)	Outer TX TX	4-sided (mm)				
WR071312306	6	6 mm	-	E8	5 mm	25.5	9.3	17	7
WR0713123063	6.3	6.3 mm	1/4"	-	-		9.9		
WR071312307	7	7 mm	9/32"	-	-		10.9		
WR071312308	8	8 mm	5/16"	E10	-		11.8		
WR071312309	9	9 mm	11/32"	-	-		13.4		
WR071312310	10	10 mm	3/8"	E12	8 mm		14.6		
WR071312311	11	11 mm	7/16"	E14	9 mm		15.9		
WR071312312	12	12 mm	15/32"	E16	10 mm		17		
WR071312313	13	13 mm	1/2"	-	-		18.4		
WR071312314	14	14 mm	9/16"	E18	-		19.6		18
WR071312315	15	15 mm	19/32"	-	12 mm	20.9	19		
WR071312316	16	16 mm	5/8"	E20	13 mm	22	20		
WR071312317	17	17 mm	-	-	14 mm	23.4	21		
WR071312318	18	18 mm	-	E22	-	24.5	21.5		
WR071312319	19	19 mm	3/4"	E24	-	25.6	22.5		
WR071312320	20	20 mm	25/32"	-	16 mm	29	26.8	23.5	14
WR071312321	21	21 mm	13/16"	E26	17 mm		27.9	24.5	
WR071312322	22	22 mm	7/8"	E28	18 mm		29.6	26	

ZEBRA 3/8 INCH MULTI-SOCKET ASSORTMENT (22 PIECES)



Item # WR096512022 22 piece set

Newly developed multi-purpose profile fitting the 5 most common screw heads

- Hexagon metric, square metric, bi-hexagon metric, hexagon inch and external Torx
- Geometry: Short
- Supplied in a metal box with high-quality foam insert compartment
- High-quality multi-use socket bits guarantee a long service life
- Chrome-plated and polished
- Bit: 12-sided, multi-profile



Hexagonal metric



Bi-hexagonal metric



Hexagon inch



Square metric



External Torx

ZEBRA STEP-UP AND STEP-DOWN SOCKET ASSORTMENT (8 PIECES)



Item # **WR09651280** 8 piece set

Combined adapter assortment with most common socket wrench and bit adapters

Socket Wrench Adapters (1 each)
 3/4" - 1/2", 1/2" - 3/4", 1/2" - 3/8",
 3/8" - 1/4", 1/4" - 3/8", 3/8" - 1/2"

Bit Adapters
 1/4" - 1/4", 3/8" - 5/16"

SOCKETS

PLIERS / CUTTERS

ZEBRA 1/2 INCH TORX, MULTI-POINT, AND ALLEN SOCKET ASSORTMENT (31 PIECES)



Item # **WR096513310** 31 piece set

Complete 1/2" assortment with short and long Allen, inner TX and multi-point sockets. Contents especially matched to automotive and cargo applications

- Metal box 350 x 260 x 55 mm (13-3/4" x 10-1/4" x 2-3/16")
- 8 TX socket wrenches, short version TX 25, 27, 30, 40, 45, 50, 55, 60
- 4 TX socket wrenches, long version TX 30, 40, 50, 60
- 4 Multi-point socket wrenches, short version M 5, 6, 8, 10
- 3 Multi-point socket wrenches, long version M 8, 10, 12
- 8 Allen socket wrenches, short version 5, 6, 7, 8, 10, 12, 14, 17 mm
- 4 Allen socket wrenches, long version 6, 8, 10, 12 mm



ZEBRA 1/2 INCH MULTI-SOCKETS

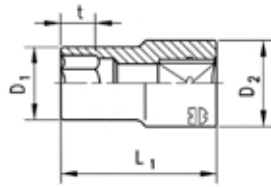

12-Point, Multi-profile for the five most common screw head drives

- Surface: Chrome-plated, polished
- Drive: 1/2" square socket
- Tip: 12-point, multi-profile

Packing & Sold In: Each

Item #	Multi-profile (mm)	Possible Uses				L1 (mm)	D1 (mm)	D2 (mm)	t (mm)
		6-pt./12-pt. (mm)	6-pt. (in.)	Outer TX TX	4-pt. (mm)				
WR071213410	10	10	3/8"	E 12	8	36	15.5	23.0	9
WR071213411	11	11	7/16"	E 14	9		16.7		10
WR071213412	12	12	15/32"	E 16	10		18.0		11
WR071213413	13	13	1/2"	-	-		19.2		13
WR071213414	14	14	9/16"	E 18	-		20.5		
WR071213415	15	15	19/32"	-	12		21.7		
WR071213416	16	16	5/8"	E 20	13		23.0		14
WR071213417	17	17	-	-	14		24.2		
WR071213418	18	18	-	E 22	-		25.5		23.5
WR071213419	19	19	3/4"	E 24	-		26.7		24.7
WR071213420	20	20	25/32"	-	16		28.0	25.5	
WR071213421	21	21	13/16"	E 26	17		29.2	26.0	
WR071213422	22	22	7/8"	E 28	18		30.5	26.5	
WR071213424	24	24	15/16"	E 30	19		33.0	29.0	
WR071213426	26	26	-	E 32	21		35.5	31.5	
WR071213427	27	27	1 1/16"	E 34	22		36.7	32.2	
WR071213428	28	28	1 1/8"	E 36	23		38.0	33.5	
WR071213430	30	30	1 3/16"	E 38	24	40.5	36.0		
WR071213432	32	32	1 1/4"	E 40	26	43.0	38.1		

ZEBRA 1/2 INCH STANDARD HEXAGON SOCKET ASSORTMENT (21 PIECES)



Item # WR09651321 21 piece set

1 ratchet

1 125mm extension

1 250mm extension

1 universal joint

17 Socket Wrench Inserts Sizes

- 3/8", 7/16", 1/2", 9/16", 19/32", 5/8", 11/16", 3/4", 25/32", 13/16", 7/8", 15/16", 1-1/16", 1-1/8", 1-3/16", 1-1/4"

ZEBRA 1/2 INCH MULTI-SOCKET ASSORTMENT (23 PIECES)



Item # WR096513023 23 piece set

- Supplied in a metal box and a high-quality foam insert to hold each piece in place
- Box: 405 x 160 x 50 mm (approx.: 16" x 6-5/16" x 2")



Item #	Designation	Tip	Length
WR07120120	Ratchet		250 mm
WR0712138105	Extension Bar		125 mm
WR0712138110	Extension Bar		250 mm
WR0712138301	Universal Joint		70 mm

Designation	Tip	Length	Item #
19 multi-sockets, 1 ea., 10-32 mm		36 - 44 mm	See table below for details

1/2" Universal Joint

- Standard: DIN 3123, ISO 3316
- Finish: Chrome-plated
- Input drive: 1/2", ball groove
- Output drive: 1/2"
- Joint: Spring-loaded, stays in set position

1/2" Extension Bars

- Standard: DIN 3123, ISO 3316
- Finish: chrome-plated
- Input drive: 1/2" ball groove
- Output drive: 1/2"

1/2" High-Performance Ratchet

- Easy handling and maximum service life
- Drive: 12.5mm / 1/2"
- Standard, DIN 3122, ISO 3315
- Head: Fine-toothed, 72 teeth, 5° rotating angle
- Chrome-plated with anti-slip 2-component handle resistant to general workplace oils and cleaners
- Top quality, tested by German TÜV SÜD product service
- Handy directional switch for easy switching, even with oily fingers; can be operated with one hand
- Chamfer on square enables easier pull-off as better gripping is possible
- Offset ratchet body enables more clearance for gripping with screw connections

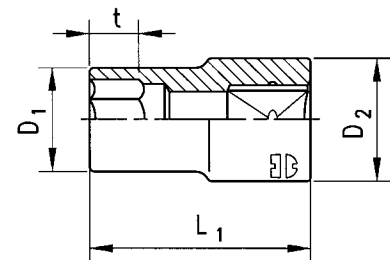

Includes:

Item #	Multi- 	Possible uses					L1 in mm	D1 in mm	D2 in mm	t in mm	
		6/12 sided/12		6 sided		in TX					
		in mm	in mm	bolt sz	head sz						
WR071213410		10	10	1/4"	3/8"	E12	8 mm	36	15.5	23	9
WR071213411		11	11	1/4"	7/16"	E14	9 mm		16.7		10
WR071213412		12	12	-	15/32"	E16	10 mm		18		11
WR071213413		13	13	5/16"	1/2"	-	-		19.2		13
WR071213414		14	14	3/8"	9/16"	E18	-		20.5		
WR071213415		15	15	-	19/32"	-	12 mm		21.7		14
WR071213416		16	16	7/16"	5/8"	E20	13 mm		23		
WR071213417		17	17	-	-	-	14 mm		24.2		23.2
WR071213418		18	18	-	-	E22	-		25.5		23.5
WR071213419		19	19	1/2"	"	E24	-		26.7		24.7
WR071213420		20	20	-	25/32"	-	16 mm		28		25.5
WR071213421		21	21	9/16"	13/16"	E26	17 mm		29.2		26
WR071213422		22	22	-	7/8"	E28	18 mm		30.5		26.5
WR071213424		24	24	5/8"	15/16"	E30	19 mm	33	29		
WR071213426		26	26	-	-	E32	21 mm	35.5	31.5		
WR071213427		27	27	-	1-1/16"	E34	22 mm	36.7	32.2		
WR071213428		28	28	3/4"	1-1/8"	E36	23 mm	38	33.5		
WR071213430		30	30	-	1-3/16"	E38	24 mm	40.5	36		
WR071213432		32	32	-	-	E40	26 mm	43	38.1	24	

Note: This is a metric set. Standard sizes are only approximate equivalencies and may not work in all applications!



MULTI-PROFILE



Suitable for the five most common screw head drives:

- Hexagon metric
- Square metric
- Bi-hexagon metric
- Hexagon standard
- TX head

ZEBRA PASS-THROUGH REVERSIBLE RATCHET ASSORTMENT (14 PIECES)



Item # WR07131300 14 piece set

- Low-profile allows for access to narrow spaces
- Pass-through feature makes this set ideal for fastening hardware to long bolts and threaded rods
- Included socket adapters (1/4" & 3/8") can be used with any standard wrench
- Includes high-quality metal box for storage and transportation

Sockets

Bit: Hexagon, metric, POWERDRIV®
Model: Chrome-plated, polished

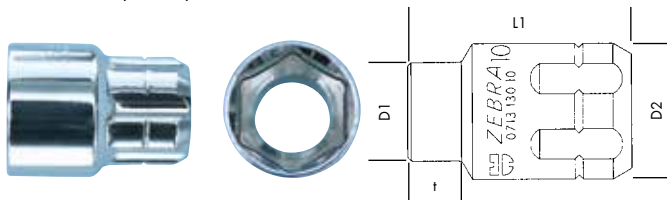

Includes:

Item #	Hexagon	L1 mm	t mm	D1 mm	D2 mm
	in mm				
WR071313010	10	32	7	14.7	19.5
WR071313011	11			15.4	
WR071313012	12			16.6	
WR071313013	13		8.5	17.7	
WR071313014	14		9.5	18.9	
WR071313015	15		11.5	20.1	
WR071313016	16		12	21.2	
WR071313017	17		22.4		
WR071313018	18		23.6		
WR071313019	19	24.8			

Item #	Designation	Length in mm
WR071313001	Ratchet	205
WR071313002	Extension	76
WR071313003	Adapter 1/4"	26
WR071313004	Adapter 3/8"	30
See table below for details	10 sockets, 10-19 mm	32

Ratchet

Head: 72 teeth, 5° rotating angle, round, compact head, one-hand operation with reversing lever for clockwise and counter-clockwise operation
Model: Chrome-plated, polished, very slim design

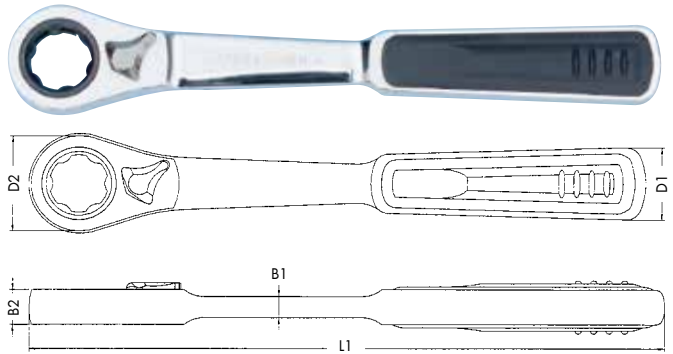

Item #	L1 mm	B1 mm	B2 mm	D1 mm	D2 mm
WR071313001	205	7	11.5	24.7	32.5

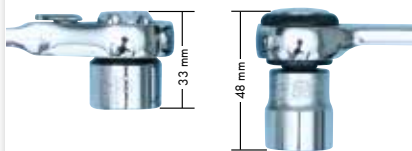

Low height of the through-ratchet as compared to the standard ratchet



Thanks to the through-hole, long bolts and threaded rods can be processed



Through-ratchet with adapter ejector enables an easy removal of the socket spanner

ZEBRA 1/4 INCH SOCKET WRENCH ASSORTMENT



Item # **WR096590001** 33 piece set



33 pcs, with drive tool

Contents:

- Hexagon socket wrench inserts: SW 4; 5; 5.5; 6; 7; 8; 9; 10; 11; 12; 13; 14
- 100 and 150 mm extension
- Universal joint
- Adapter with quick-change chuck
- 1/4 inch Ratchet
- ZEBRA handle
- 3 bits: PH1; PH2; PH3
- 1 bit slotted 0.8 x 5.5mm
- 7 bits TX: TX10; 15; 20; 25; 27; 30; 40mm
- 4 hexagon bits, sizes 3, 4, 5, 6
- Foam insert

SOCKETS

PLIERS / CUTTERS

ZEBRA 1/2 INCH SOCKET WRENCH ASSORTMENT

Item # **WR0965900201** 17 piece set



17 Pieces

- **Inner TX**
TX 20, TX 25, TX 27, TX 30, TX 40, TX 45, TX 50, TX 55, TX 60.
- **Outer TX**
E 10, E 11, E 12, E 14, E 16, E 18, E 20, E 24
- Foam insert





ZEBRA COMBINATION PLIERS



THE HANDLE IS CRITICAL

Optimal power distribution
– Comfortable grip without pressure points thanks to special handle geometry



Slim collar shape - for optimal accessibility in tight work areas



2K grip for gripping, holding and cutting hard and soft wires and cables

- DIN ISO 5746
 - High-quality steel construction ensures long tool life and precision of gripping and cutting surfaces
 - Extra-long blade also suitable for thicker cables
 - Ergonomic and slip-free 2K comfort handle with narrow collar profile for comfortable working and optimum force transfer
 - Inductively hardened precision blades
 - Burner hole for gripping round materials
 - Surface: Entirely ground and chrome-plated
 - Joint: Lap joint
- Packing & Sold In: Each

Item #	Length (in.)	Length (mm)	Medium-hard wire ●	Hard wire ●	Copper and aluminum cable ☺	
WR071401554	6 - 1/2"	170	3.1 mm diameter	2.0 mm diameter	10.0 mm diameter	16 mm ²
WR071401555	7"	180	3.4 mm diameter	2.2 mm diameter	12.0 mm diameter	
WR071401556	8"	200	3.8 mm diameter	2.5 mm diameter	13.0 mm diameter	

ZEBRA NEEDLE NOSE PLIERS



2K grip for gripping, holding and cutting soft and hard wires and cables

- DIN ISO 5745
- High-quality steel construction ensures long tool life and precision of gripping and cutting surfaces
- Elastic tips for high stresses, especially under bending forces
- Ergonomic and slip-free 2K comfort handle with narrow collar profile for comfortable working and optimum force transfer
- Blades: Additional inductive hardening
- Surface: Entirely ground and chrome-plated
- Gripping surfaces: Toothed
- Joint: Lap joint

Packing & Sold In: Each

Item #	Length (in)	Length (mm)	Tip geometry	Jaw shape	L3 (mm)	W3 (mm)	T1 (mm)	W4 (mm)	T2 (mm)
WR071401557	8-1/4"	210			76	17.5	9.5	4	3
WR071401558				$\sphericalangle 40^\circ$	72				
WR071401559	6-1/4"	160			50	16.5	9	3	2.5
WR071401562				$\sphericalangle 40^\circ$	46				

ZEBRA SIDE CUTTERS



2K grip for cutting hard and soft wires and cables, including in hard-to-reach places

- DIN ISO 5749
- High-quality tool steel ensures long service life and precision of blades
- Slim head shape for optimum accessibility
- Ergonomic and slip-free 2K comfort handle with narrow collar profile for comfortable working and optimum force transfer
- Inductively hardened precision blades
- Surface entirely ground and chrome-plated
- Lap joint

Packing & Sold In: Each



Milled precision cutting edge saves strength and gives a clean cut!

Item #	Length (in.)	Length (mm)	Soft wire	Medium-hard wire	Hard wire
WR071401566	5 - 1/2"	140	4.0 mm diameter	2.5 mm diameter	1.8 mm diameter
WR071401567	6 - 1/4"	160		2.8 mm diameter	2.0 mm diameter
WR071401568	7"	180		3.0 mm diameter	2.5 mm diameter

ZEBRA POWER SIDE CUTTERS



2K grip for cutting piano wire, hard and soft wire

- DIN ISO 5749
 - Strength-saving. Milled precision cutting edge for clean cuts
 - High-quality steel ensures long service life and precision of blades
 - Ergonomic and slip-free 2K comfort grip handle with narrow collar profile for comfortable working and optimum force transfer
 - Inductively hardened precision blades
 - Surface: Ground and chrome-plated
 - Joint: Lap joint, forged-on rivets
- Packing & Sold In: Each

Item #	Length (in.)	Length (mm)	Soft wire	Medium-hard wire	Hard wire	Piano wire
WR071401551	5 - 1/2"	140	4.0 mm diameter	3.1 mm diameter	2.0 mm diameter	1.5 mm diameter
WR071401552	6 - 1/4"	160		3.4 mm diameter	2.5 mm diameter	2.0 mm diameter
WR071401553	7"	180		3.8 mm diameter	2.7 mm diameter	2.2 mm diameter
WR071401598	8"	200	4.5 mm diameter	4.2 mm diameter	3.0 mm diameter	2.5 mm diameter

ZEBRA HEAVY-DUTY SIDE CUTTERS, REVERSIBLE



2 tools in one: Side cutters with connectible lever transmission

- High cutting power cuts thick cables
 - Avoids hard cutting impact found with conventional side cutters
 - Precision cutting ensures a long service life
 - Manufactured from high-grade steel
 - Safe handling
 - Ergonomic 2K plastic handle with non-slip surface
 - Surface: Chrome-plated
 - Joint: Launched
- Packing & Sold In: Each



2 in 1!

Side cutters with connectible lever transmission

By pressing the power button, you get twice the cutting power!



Item #	Length (in.)	Length (mm)	Soft wire	Medium-hard wire	Hard wire	Piano wire
WR071401599	8"	200	5 mm diameter	4.5 mm diameter	3.5 mm diameter	3 mm diameter

ZEBRA WIRE STRIPPING PLIERS



2K grip, precise, effortless stripping of cables and wires with plastic or rubber insulation

- High-quality steel construction
- Long service life and precision of cutting surfaces.
- For single, multi and fine-wire conductors
- Opening spring opens pliers automatically
- Ergonomic and non-slip 2K comfort handle with narrow collar profile
- Comfortable working and optimum power transmission
- Adjustment screw can be fixed in place with knurled nut
- Surface: Entirely ground and chrome-plated
- Joint: Lap joint

Packing & Sold In: Each

Item #	Length (in)	Length (mm)	Diameter (mm)	(mm) ²
WR071401550	6-1/4"	160	5	10

ZEBRA WATER PUMP PLIERS



2K grip, self-locking water pump pliers with push-button adjustment

- DIN ISO 8976
- Rapid and convenient fine adjustment at the push of a button
- Hardened precision teeth
- High wear resistance and secure grip
- Ergonomic and non-slip 2K comfort handle with narrow collar profile
- Comfortable working and optimum power transmission
- Huge gripping capacity with slim design

Packing & Sold In: Each

Item #	Length (in)	Length (mm)	Min./Max. Grip Range
WR071401563	10"	250	16 - 46 mm



With
**PUSH BUTTON
ADJUSTMENT**
and hardened precision teeth

ZEBRA PLIERS AND CUTTERS SETS

WRENCHES

ALLEN KEYS

RIVETERS

SCREWDRIVERS

T-HANDLES

BITS

RATCHETS



Includes:

Item #	Contents	Length (in)	Length (mm)
WR071401555	Zebra	7"	180
WR071401550	Zebra Wire	6-1/4"	160
WR071401557	Zebra Needle	8-1/4"	210



Item # **WR071401560** 4 piece set

2K grip, set of one of each combination pliers, wire stripping pliers, needle nose pliers, and power side cutters

- High-quality steel construction ensures long service life and precision of gripping and cutting surfaces
- Combination pliers with extra-long blade also suitable for thicker cables
- Wire stripping pliers with opening spring for automatic opening
- Needle nose pliers with tips for high bending stresses
- Heavy-duty side cutters for piano wire, hard and soft wire
- Ergonomic and slip-free 2K comfort handle with narrow collar profile for comfortable working and optimum force transfer



Includes:

Item #	Contents	Length (in)	Length (mm)
WR071401555	Zebra	7"	180
WR071401563	Zebra Water	10"	250
WR071401557	Zebra Needle	8-1/4"	210
WR071401552	Zebra Power	6-1/4"	160



Item # **WR071401565** 4 piece set

2K grip, set of one of each combination pliers, water pump pliers, needle nose pliers, and power side cutters

- High-quality steel construction ensures long service life and precision of gripping and cutting surfaces
- Combination pliers with extra-long blade also suitable for thicker cables
- Water pump pliers with convenient quick adjustment
- Needle nose pliers with tips for high bending stresses
- Heavy-duty side cutters for piano wire, hard and soft wire
- Ergonomic and slip-free 2K comfort handle with narrow collar profile for comfortable working and optimum force transfer

ZEBRA PLIERS ASSORTMENT



THE HANDLE IS CRITICAL

Optimal power distribution
– Comfortable grip without pressure points thanks to special handle geometry



Item # **WR0965900600** 4 piece set

2K Grip

- 4 piece set of 2K grip pliers
- Foam drawer insert and cutters

Includes:

Item #	Contents	Length (in)	Length (mm)
WR071401555	Zebra	7"	180
WR071401563	Zebra Water	10"	250
WR071401557	Zebra Needle	8-1/4"	210
WR071401552	Zebra Power	6-1/4"	160



Side cutters:
160 mm



Combination pliers:
180 mm



Needle nose pliers:
210 mm



Water pump pliers:
250 mm



CIRCLIP PLIERS FORM A/B



For shaft locking rings

Standard: DIN 5254

Handle: Plastic-coated

Guarantees a secure grip, prevents slippage

Compressed Spring Steel Tip

- Optimized stability for use with tight fitting and seized rings

Inserted Tips

- Offers maximum strength when loosening tight-fitting/seized rings and allows rings to be installed with minimal distortion

Screwed and Mounted Joint

- High precision and optimized movement

Large Contact Surfaces

- Rings mounted with minimal torsion

Pliers Head

- Slim design for optimum access to work piece, especially in hard-to-reach areas

Internal Spring

- Lies protected in the internal joint

Packing & Sold In: Each

Item #	Length (mm)		Min./Max. grip range	Tenon diameter (mm)	Jaws length (mm)	Hook length (mm)
WR07140211	140	A Straight	3 - 10	0.9	39	-
WR07140212			10 - 25	1.25	38	
WR07140213			19 - 60	1.8	56	
WR07140214			40 - 100	2.25	70	
WR07140215	320		85 - 140	3.2	92	
WR07140216	130	B 90°	3 - 10	0.9	27	12
WR07140217			10 - 25	1.25		
WR07140218			19 - 60	1.8	40	15
WR07140219			40 - 100	2.25	55	16
WR07140220			305		85 - 140	3.2

CIRCLIP PLIERS FORM C/D



For retaining rings (bore circlips)

Standard: DIN 5256

Handle: Plastic-coated

- Guarantees a secure grip, slip-resistant

Compressed Spring Steel Tip

- Optimized stability for use with tight-fitting and seized rings

Inserted Tips

- Offers maximum strength when loosening tight-fitting/seized rings and allows rings to be installed with minimal distortion

Screwed and Mounted Joint

- High precision and optimized movement

Large Contact Surfaces

- Rings mounted with minimal torsion

Pliers Head

- Slim design for optimum access to work piece, especially in hard-to-reach areas

Packing & Sold In: Each

Item #	Length (mm)		Min./Max. grip range	Tenon diameter (mm)	Jaws length (mm)	Hook length (mm)
WR07140201	140	C Straight	8 - 13	0.9	39	-
WR07140202			12 - 25	1.25	38	
WR07140203			19 - 60	1.8	54	
WR07140204			40 - 100	2.25	65	
WR07140205	320		85 - 140	3.2	91	
WR07140206	130	D 90°	8 - 13	0.9	26	12
WR07140207			12 - 25	1.25		
WR07140208			19 - 60	1.8	40	14
WR07140209			40 - 100	2.25	49	16
WR07140210			305		85 - 140	3.2

CIRCLIP PLIER SET (4 PIECES)

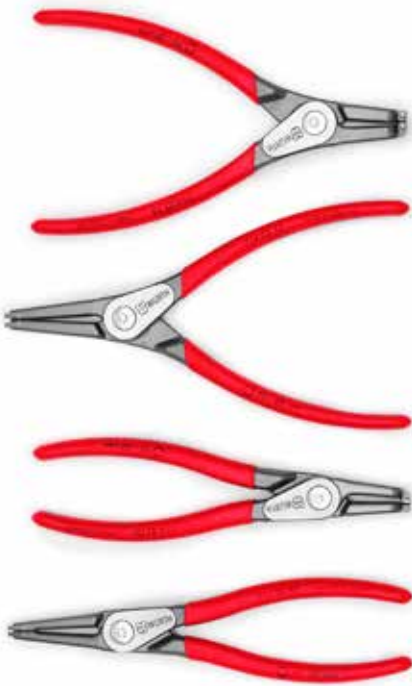

Item # **WR07140230** 4 piece set

4-piece set

Handle: Plastic-coated

- Guarantees a secure grip, prevents slippage

Tip from compressed spring steel

- Optimized stability, even with seized rings

Inserted tips

- Offers maximum strength when loosening seized rings and allows rings to be installed with minimal distortion

Screwed and mounted joint

- High precision and optimized movement

Includes:

Item #	Form / Grip Range
WR07140213	Form A, 19 - 60 mm
WR07140218	Form B, 19 - 60 mm
WR07140203	Form C, 19 - 60 mm
WR07140208	Form D, 19 - 60 mm

Large locating faces

- Rings mounted without torsion

Pliers head

- Narrow design for optimum access to workpiece, including in hard-to-reach spots

Contents:

- Form A Circlip Pliers, 19 - 60 mm grip range
- Form B Circlip Pliers, 19 - 60 mm grip range
- Form C Circlip Pliers, 19 - 60 mm grip range
- Form D Circlip Pliers, 19 - 60 mm grip range

ZEBRA VICE-GRIP LOCKING PLIERS



Features:

- Effortless release lever with spring mechanism
- One-hand operation – pull-action rather than push-action
- Lock nut for fixing clamping width, setting retained for repetitive applications
- Ergonomic design
- Comfortable and effortless handling
- High-quality epoxy coating, welding beads roll off
- 10x better rust resistance than Nickel coatings

Packing & Sold In: Each



Straight jaws

Item #	Length (mm)	Clamping width (mm)
WR07150909	190	0-42
WR07150910	235	0-63



Long straight jaws

Item #	Length (mm)	Clamping width (mm)
WR07150904	235	0-70



Semi-circular jaws

Item #	Length (mm)	Clamping width (mm)
WR07150906	135	0-30
WR07150907	190	0-42
WR07150908	235	0-63

WRENCHES
ALLEN KEYS
RIVETERS
SCREWDRIVERS
T-HANDLES
BITS
RATCHETS





ZEBRA SHEET METAL SNIPS - SHORT LENGTH



Maneuverable , powerful and compact

Double Leverage

- Lower application of force with simultaneously increased cutting performance
- No slipping and no serration

Perfect Design

- Small and lightweight
- Easily stores in most pockets

Extremely Compact Shearing Head

- Ideal for cutting extremely tight radii and for hard-to-reach places

Combined Lock and Stop

- Combined lock and stop for improved safety
- Cutting snips can be quickly and easily closed and kept closed

Ergonomically shaped handle

- Easy to grip
- Allows for lower fatigue

Packing & Sold In: Each

Item #	Version	Length (mm)	Cutting capacity (mm)	
			Steel	Stainless Steel
WR071303200	Right-hand cutting	180	1.2	0.8

ZEBRA SHEET METAL SNIPS



Leverage sheet metal cutting snips for continuous and shaped cuts

Rounded grip made from 2-component plastic

- Prevents hands from slipping

Lower handle made from 1-component plastic

- Simply slide your finger over the lower handle when opening and closing the handle

Handle heights prevent the cutting snips from slipping out of your hand

- Allows for safe execution

Long service life

- Cutting head manufactured from stainless steel, die-forged
- Induction hardened cutting edges

Non-serrated cutting geometry

- Helps prevent sheet metal slipping

Lever transmission

- High cutting power with less effort

Packing & Sold In: Each



Ideal Snips

For continuous and figure cutting

Item #	Version	Length (mm)	Cutting capacity (mm)	
			Steel	Stainless Steel
WR071303100	Right-hand cutting	260	1.8	1.2
WR071303110	Left-hand cutting			



Ideal Carbide Snips

With carbide cutting edges for continuous and figure cutting

- Longer service life
- Especially suitable for cutting stainless steel

Item #	Version	Length (mm)	Cutting capacity (mm)	
			Steel	Stainless Steel
WR071303130	Right-hand cutting	260	1.8	1.2
WR071303135	Left-hand cutting			



Figure Snips

For continuous and tight figure cutting

Item #	Version	Length (mm)	Cutting capacity (mm)	
			Steel	Stainless Steel
WR071303115	Right-hand cutting	260	1.8	1.2
WR071303120	Left-hand cutting			



LIMITED EDITION TOOL SETS

- Limited edition with Reinhold Würth signature
- Tool sizes are marked on the insert for easy organization

Limited Edition Drill And Drive Set, 31 Piece

For more detail -
See wurthlac.com

Item #
WR0624932020

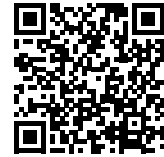

Limited Edition Socket and Drive Set, 46 Piece

For more detail -
See wurthlac.com

Item #
WR09652019



Limited Edition Double Ratcheting Wrench Set, 29 Piece

For more detail -
See wurthlac.com

Item #
WR07142020



WÜRTH LOUIS AND COMPANY

LIMITED WARRANTY POLICY - HAND TOOLS

Würth Louis and Company – Limited Warranty Policy

This limited warranty policy ("Limited Warranty Policy") represents Würth Louis and Company ("the Company") commitment to our customers and our effort in ensuring the quality of our products. If you are the original purchaser of our product, the Company warrants, for the time period indicated below (the "Warranty Coverage"), each Würth Louis and Company product to be free from defects in materials and workmanship under normal use and service, when installed, adjusted, used, and maintained, in the manner they were intended.

WÜRTH PRODUCT	WARRANTY COVERAGE
<ul style="list-style-type: none"> "Zebra" brand hand tools 	<p>Limited lifetime warranty</p> <p>Würth Louis and Company warrants these products for its useful life against deficiencies in material and workmanship</p>
<ul style="list-style-type: none"> Würth brand hand tools 	<p>1-year Limited Warranty</p> <p>Würth Louis and Company warrants these products for one (1) year from the date of purchase of the original purchaser</p>
<p>Please note that the Limited Lifetime Warranty and the 1-year Limited Warranty are subject to the provisions and limitations contained in this Limited Warranty Policy and in any applicable Würth Louis and Company terms and conditions of sale.</p>	

Repair, replacement (same or similar product), or credit at the original sale price at Würth Louis and Company's option will be furnished if the product, upon Würth's standard investigation process, is found to be properly installed, adjusted, used, maintained, stored, and/or operated. Any such repairs or replacement will be made at no charge to the customer for parts or labor, provided that the customer shall be responsible for any transportation, lodging, meals, and/or other personal costs. This Limited Warranty Policy does not apply to any malfunctions caused by: (i) normal wear and tear, (ii) unreasonable and/or improper use, misuse, neglect, abuse, improper storage, improper exposure to elements, and/or insufficient maintenance, (iii) repair or service by unauthorized persons, and (iv) modifications and/or alterations made without the express written permission of Würth Louis and Company.

Würth Louis and Company consumable products are free from manufacturer's defect upon delivery but do not carry any further warranty unless specifically expressed on the product itself. This limited warranty is non-transferrable and can only be availed by the original purchaser of the product. A proof of purchase is required for all warranty claims. To obtain warranty service, contact your sales representative for warranty assistance or call 1-800-263-5002 for your nearest authorized Würth Louis and Company sales representative.

EXCEPT FOR THE LIMITED WARRANTY PROVIDED HEREIN, TO THE EXTENT PERMITTED BY LAW, WÜRTH DISCLAIMS ALL OTHER WARRANTIES, EXPRESS OR IMPLIED, INCLUDING ALL WARRANTIES OF MERCHANTABILITY AND/OR FITNESS FOR A PARTICULAR PURPOSE. TO THE EXTENT THAT ANY IMPLIED WARRANTIES MAY NONETHELESS EXIST BY OPERATION OF LAW, ANY SUCH WARRANTIES ARE EXPRESSLY LIMITED TO THE WARRANTY COVERAGE PERIOD ASSOCIATED WITH EACH PRODUCT STATED HEREIN.

The terms in this Limited Warranty Policy represent Würth Louis and Company's exclusive written warranty. Würth Louis and Company makes no other express warranty, nor is anyone authorized to make any warranties on its behalf.

REPAIR OR REPLACEMENT OF Würth Louis and Company PRODUCTS, AS PROVIDED HEREIN, IS YOUR EXCLUSIVE REMEDY. WÜRTH LOUIS AND COMPANY SHALL NOT BE LIABLE FOR ANY SPECIAL, INCIDENTAL, ECONOMIC OR CONSEQUENTIAL DAMAGES, INCLUDING, BUT NOT LIMITED TO, LOST REVENUES, LOST PROFITS, STRICT LIABILITY IN TORT AND/OR IN NEGLIGENCE, AND THIRD PARTY CLAIMS, INCIDENTAL OR CONSEQUENTIAL, LABOR COSTS, INSTALLATION CHARGES, TELEPHONE CHARGES, OR TRANSPORTATION CHARGES IN CONNECTION WITH THE REPLACEMENT AND/OR REPAIR OF DEFECTIVE PARTS OR PRODUCTS.

Customer understands that Würth Louis and Company is a distributor only and as such, Würth Louis and Company assumes no liability whatsoever with regard to the original purchaser's compliance or fulfillment of its obligations with respect to any statute, regulation, or by-law. Please note that while Würth Louis and Company has made diligent efforts to illustrate and describe the products shown in its catalogues and online media, these illustrations and descriptions however, are for the sole purpose of identification and do not express nor imply a warranty or condition that the products shown are merchantable, fit for a particular purpose, nor does it guarantee that the products will necessarily conform to the illustrations and descriptions. Würth Louis and Company reserves the right to make changes in design, appearance, and construction of any and all Würth Louis and Company products and reserves the right to discontinue the availability of any products and/or service to any discontinued products, at any time, at its sole discretion. Würth Louis and Company assumes no responsibility whatsoever in making such changes in products previously sold and/or transferred. Further, Würth Louis and Company assumes no obligation in replacing any previously sold,



Würth Louis and Company

HAND TOOLS

Würth Louis and Company

895 Columbia Street
Brea, CA 92821
www.wurthlac.com
(714) 529-1771
(800) 422-4389

Other locations:

Anaheim, CA
Benton, AR
Boise, ID
Denver, CO
Grand Prairie, TX
Houston, TX

Idaho Falls, ID
Lacey, WA
Las Vegas, NV
Oklahoma City, OK
Phoenix, AZ
Portland, OR

Post Falls, ID
Salt Lake City, UT
San Antonio, TX
San Marcos, CA
St. George, UT
West Jordan, UT