



»» eliteplus

Concealed Drawer Slides

G*GRASS®





Grass Elite Plus



Concealed undermount drawer slide

>>> eliteplus

The innovative Elite Plus drawer slide draws attention to the beauty of your cabinetry and leaves the mounted hardware completely out of sight. The Elite Plus brings together the advances of undermount technology with a precision roller carriage. The Elite Plus offers a new improved soft-closing action with the Airmatic closing device. The Airmatic uses natural, clean air to deliver a soft, quiet closing action every time.

Offered in a full range of lengths for frameless and face frame construction, the Elite Plus features a full drawer extension for maximum use of interior space. It is a proven undermount slide with an ample load capacity of 80 lbs. that meets and exceeds ANSI/BHMA testing standards. Grass Elite Plus is rated ANSI /BHMA 156.9 grade 1 drawer slide (Type B05011).

Year after year, Elite Plus enables drawers to function quietly and flawlessly with the quality construction and Grass standard of excellence you have come to expect.

The Elite Plus is backed by the Grass Limited Lifetime Warranty. It's what's inside that counts, even when you can't see it. You can specify Elite Plus with confidence.



Grass Elite Plus

Airmatic shock absorber system

»» eliteplus ... with an even better Soft-close action!



With Airmatic, the pulling force needed to open an Elite Plus equipped drawer is minimal. The superb closing action will surprise customers.

The repositioned Airmatic damper and spring cam action gives the Elite Plus an improved closing action.



The Airmatic piston absorbs the force and noise of a slammed drawer and gently allows the drawer to shut.



Increased steel thickness and additional re-enforcement bar added to cabinet member to reduce flexing. A larger cabinet member front has been designed rather than a cut out section.



The unique oil-free shock absorber utilizes only a cushion of air for safe and hygienic use.



Redesigned damper holder for additional stability.

Installation and adjustment features

Standard locking device

with height adjustment



Move green adjustment plate forward and back

The standard front locking device allows aligning the height of the drawer. A 2.5mm [$\frac{3}{32}$ "] upwards adjustment is achieved via the green adjustment plate by moving it forward and back.

Flange mount locking device

with height adjustment



Move green adjustment plate forward and back

This special front locking device features a flange for easy mounting to the bottom of the drawer. The height of the drawer can be adjusted by 2.5mm [$\frac{3}{32}$ "] via the green adjustment plate.

Self-aligning rear mount brackets



Brackets self-align the drawer when cabinets are out of square, ± 2 mm [$\frac{3}{32}$ "] adjustment range.

Depth adjustment

For frameless or inset applications (when blocked out)

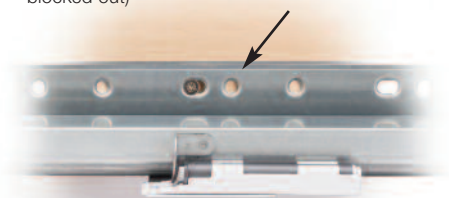

Use #7 Euro or wood screw for slotted locations.

The depth position of the drawer is perfectly aligned via slotted hole offering a 4mm [$\frac{5}{32}$ "] adjustment range. Use #7 Euro or wood screw.

Tilt adjustment

For frameless or inset applications (when blocked out)

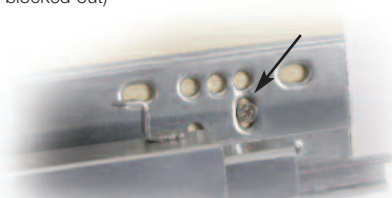

Use #7 Euro or wood screw for slotted locations.

The vertical slotted hole allows tilting the drawer for perfect front alignment with a 4mm [$\frac{5}{32}$ "] adjustment range.

Frame stop tab

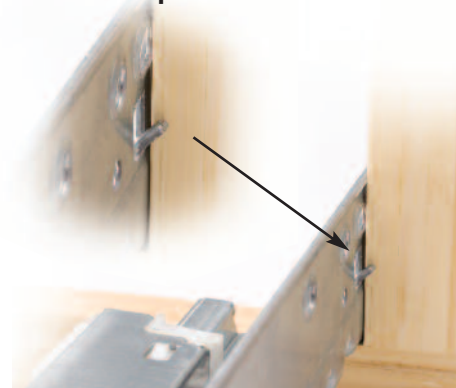

The tab quickly locates the slide on the face frame at the correct setback. Use a flat head screwdriver to bend out the tab.

Grass Elite Plus 16

Full Extension Slide for 16mm [$\frac{5}{8}$ "] maximum drawer side thickness



Description

- Slides mount underneath to give a full view of finely crafted drawers
- Zinc plated, roll formed steel components
- Precision, smooth-running synthetic roller carriages
- Airmatic shock absorber softly glides drawers to a stop
- Self-latching front locking devices have comfortable release levers for drawer removal
- Front locking device height adjustable 2.5mm [$\frac{1}{32}$ "]
- Self-aligning rear brackets for face frame applications $\pm 2\text{mm}$ [$\frac{3}{32}$ "]
- Positive tracked right side, $\pm 1.5\text{mm}$ [$\frac{1}{16}$ "] side tolerance on left side
- Self-closing springs engage 30mm [$1 \frac{1}{4}$ "] before closed position
- Weight capacity: 80 lbs. dynamic, 100 lbs. static
- Exceeds ANSI/BHMA 156.9, grade 1, Type B05011 drawer slide, test standards

How to specify hardware:

1. Determine required drawer length - select drawer slide
2. Select front locking device - 1 left and 1 right required per drawer
3. Select rear mounting bracket - 2 required per drawer for face frame applications only

Components

ID	Description	Drawer Length	Reference #	Item # (5 sets/box)	Item # (200 sets bulk)
1	Elite Plus 7523-16 with Airmatic	240 [$9 \frac{5}{8}$ "]	7523-16/250/240	76028-03	-
		305 [12 "]	7523-16/317/305	76030-03	-
		381 [15 "]	7523-16/394/381	76033-03	76033-12
		457 [18 "]	7523-16/470/457	76035-03	76035-12
		533 [21 "]	7523-16/550/533	76050-03	76050-12

ID	Description	Item #	Pkg.
2a	7523 Front locking device kit*	02614-03	5
		02614-12	200
	Locking device Left	02615-12	200
	Locking device Right	02616-12	200



ID	Description	Item #	Pkg.
2b	7523 Front locking device kit* with flange	02613-03	5
		02613-12	200
	Locking device Left	02611-12	200
	Locking device Right	02612-12	200



*Kit: Right/Left locking device, (4) #6 x 1/2" flat head phillips screws.

ID	Description	Item #	Pkg.
3	7523 Universal rear mount bracket	02051-15	300



Note: Plug-in brackets available on page 10.

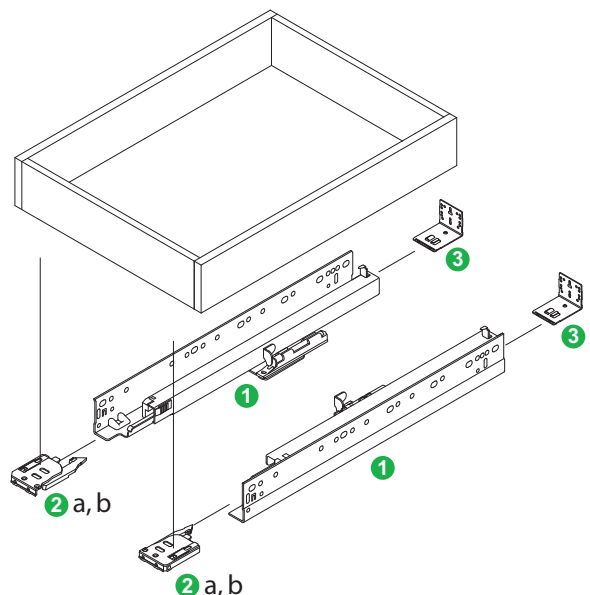

Rear Bracket Position

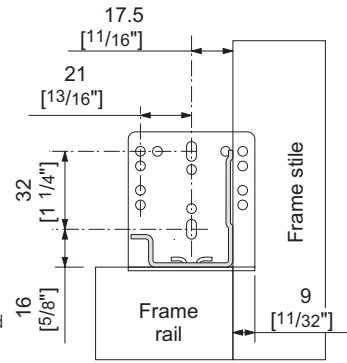
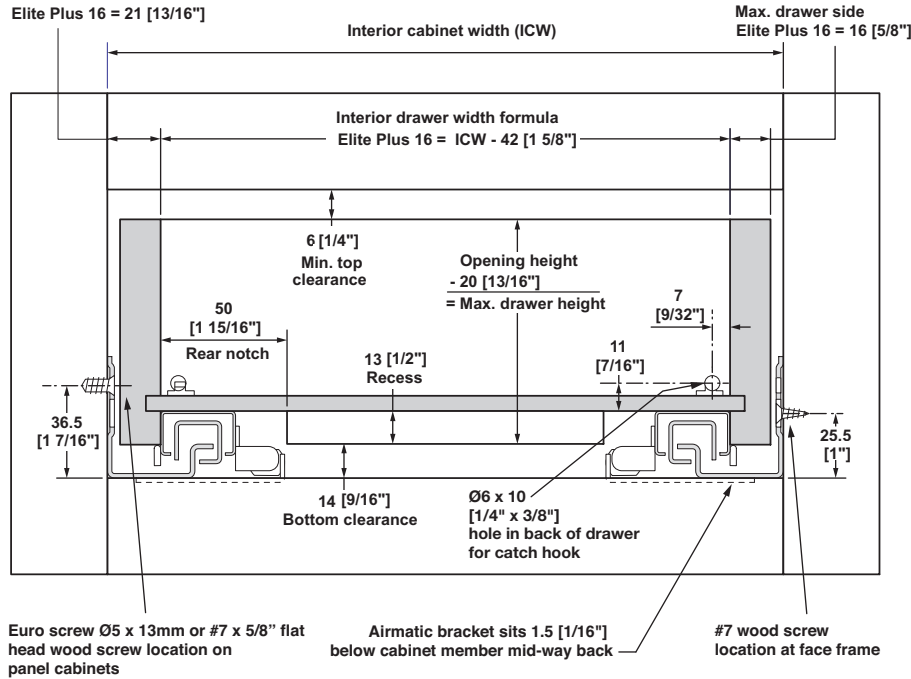

For face frame applications only.
Use minimum of 3 screws per bracket, #6 x 1/2" truss head screws.

Calculation Outside Drawer Width					
Drawer side thickness	16 [5/8"]	15 [1 1/32"]	14 [9/16"]	13 [1/2"]	12 [1 1/32"]
Deduct from interior cabinet width	10 [3/8"]	12 [1 1/32"]	14 [9/16"]	16 [5/8"]	18 [2 3/32"]

Assembly Details

Frameless Applications 32mm compatible

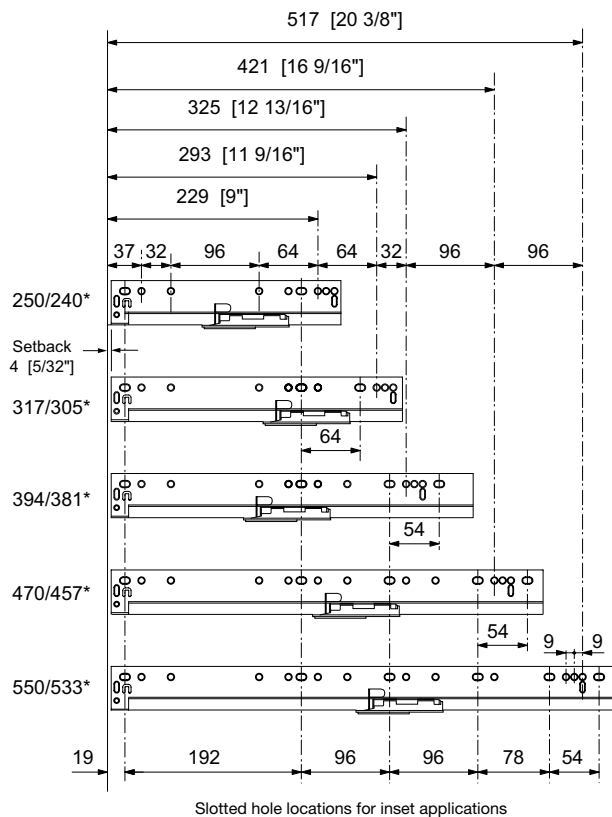

*Cabinet member length / Drawer length (mm)

Reference #	Drawer Length	Interior Cabinet Depth with Universal Bracket	
		Minimum*	Maximum
7523-16/250/240	240 [9 7/16"]	259 [10 3/16"]	296 [11 5/8"]
7523-16/317/305	305 [12"]	329 [12 15/16"]	363 [14 3/16"]
7523-16/394/381	381 [15"]	407 [16"]	440 [17 5/16"]
7523-16/470/457	457 [18"]	479 [18 7/8"]	516 [20 5/16"]
7523-16/550/533	533 [21"]	562 [22 1/8"]	596 [23 7/16"]

*For frameless applications, deduct 1.5 [1/16"] for minimum interior cabinet depth.

Face Frame Applications

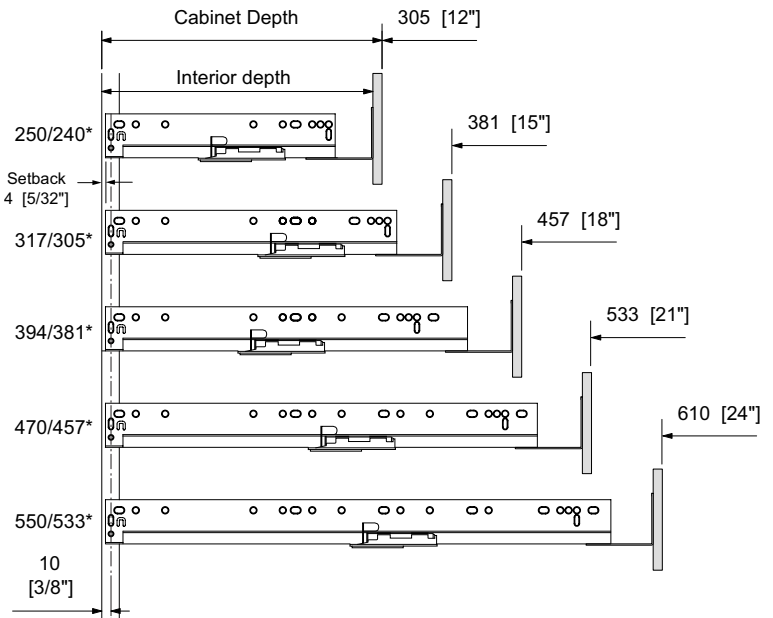

Subject to technical modifications without notice.

Grass Elite Plus 19

Full Extension Slide for 19mm [$\frac{3}{4}$ "] maximum drawer side thickness



Description

- Slides mount underneath to give a full view of finely crafted drawers
- Zinc plated, roll formed steel components
- Precision, smooth-running synthetic roller carriages
- Airmatic shock absorber softly glides drawers to a stop
- Self-latching front locking devices have comfortable release levers for drawer removal
- Front locking device height adjustable 2.5mm [$\frac{1}{32}$ "]
- Self-aligning rear brackets for face frame applications $\pm 2\text{mm}$ [$\frac{3}{32}$ "]
- Positive tracked right side, $\pm 1.5\text{mm}$ [$\frac{1}{16}$ "] side tolerance on left side
- Self-closing springs engage 30mm [$1 \frac{1}{4}$ "] before closed position
- Weight capacity: 80 lbs. dynamic, 100 lbs. static
- Exceeds ANSI/BHMA 156.9, grade 1, Type B05011 drawer slide, test standards

How to specify hardware:

1. Determine required drawer length - select drawer slide
2. Select front locking device - 1 left and 1 right required per drawer
3. Select rear mounting bracket - 2 required per drawer for face frame applications only

Components

ID	Description	Drawer Length	Reference #	Item # (5 sets/box)	Item # (200 sets bulk)
1	Elite Plus 7523-19 with Airmatic	240 [$9 \frac{5}{8}$ "]	7523-19/250/240	76029-03	-
		305 [12 "]	7523-19/317/305	76032-03	-
		381 [15 "]	7523-19/394/381	76034-03	76034-12
		457 [18 "]	7523-19/470/457	76049-03	76049-12
		533 [21 "]	7523-19/550/533	76052-03	76052-12

ID	Description	Item #	Pkg.
2a	7523 Front locking device kit*	02614-03	5
		02614-12	200
	Locking device Left	02615-12	200
	Locking device Right	02616-12	200

ID	Description	Item #	Pkg.
2b	7523 Front locking device kit* with flange	02613-03	5
		02613-12	200
	Locking device Left	02611-12	200
	Locking device Right	02612-12	200

*Kit: Right/Left locking device, (4) #6 x 1/2" flat head phillips screws.

ID	Description	Item #	Pkg.
3	7523 Universal rear mount bracket	02051-15	300

Note: Plug-in brackets available on page 10.

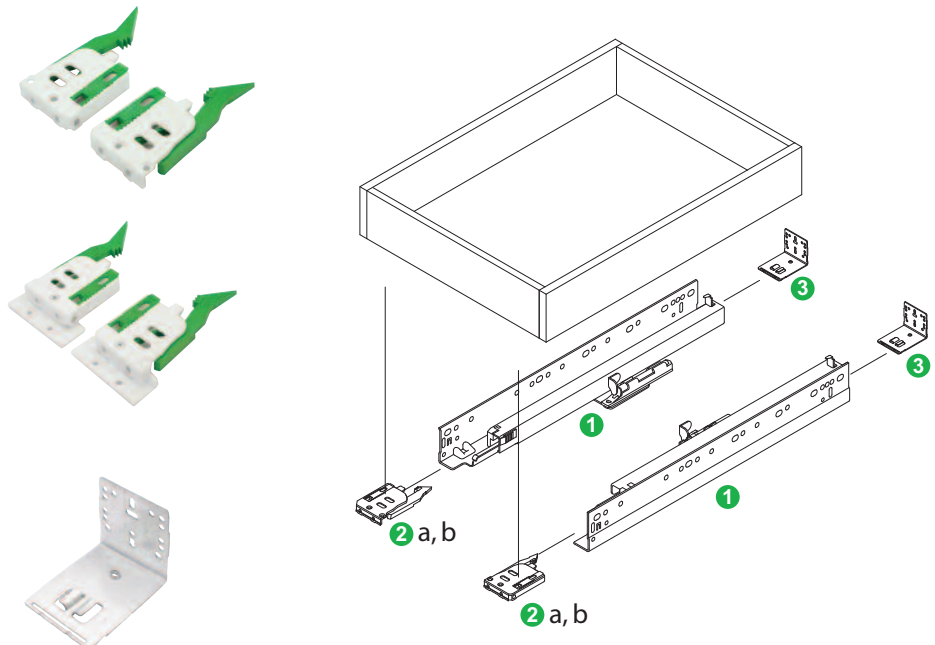

Rear Bracket Position

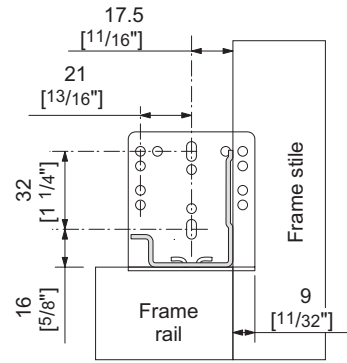
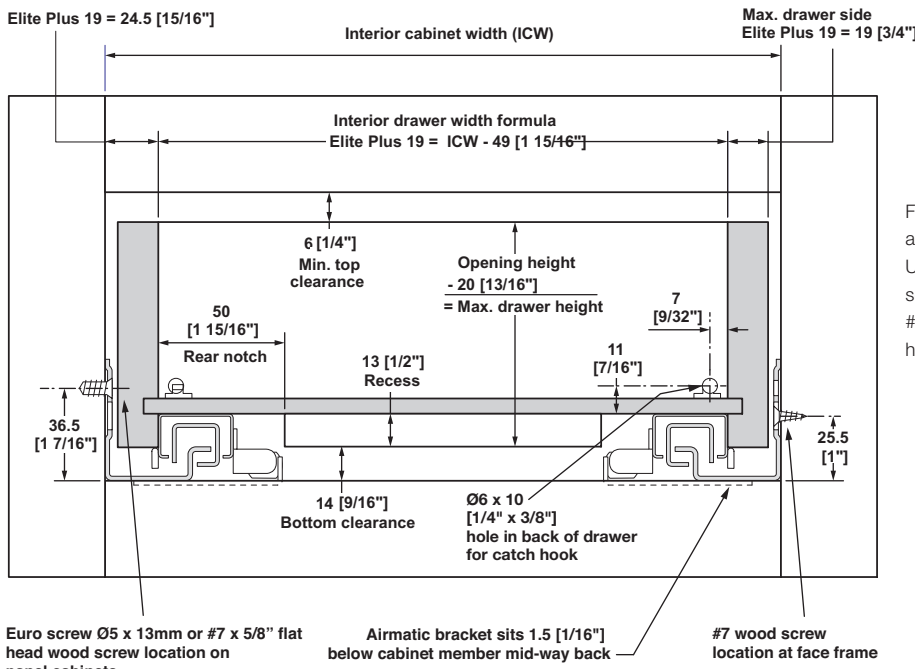

For face frame applications only.
Use minimum of 3 screws per bracket,
6 x 1/2" truss head screws.

Calculation Outside Drawer Width					
Drawer side thickness	19 [3/4"]	17 [1 1/8"]	16 [5/8"]	14 [1 1/16"]	13 [1/2"]
Deduct from interior cabinet width	11 [7/16"]	15 [1 1/32"]	17 [1 1/8"]	21 [1 3/16"]	23 [7/8"]

Assembly Details

Frameless Applications 32mm compatible

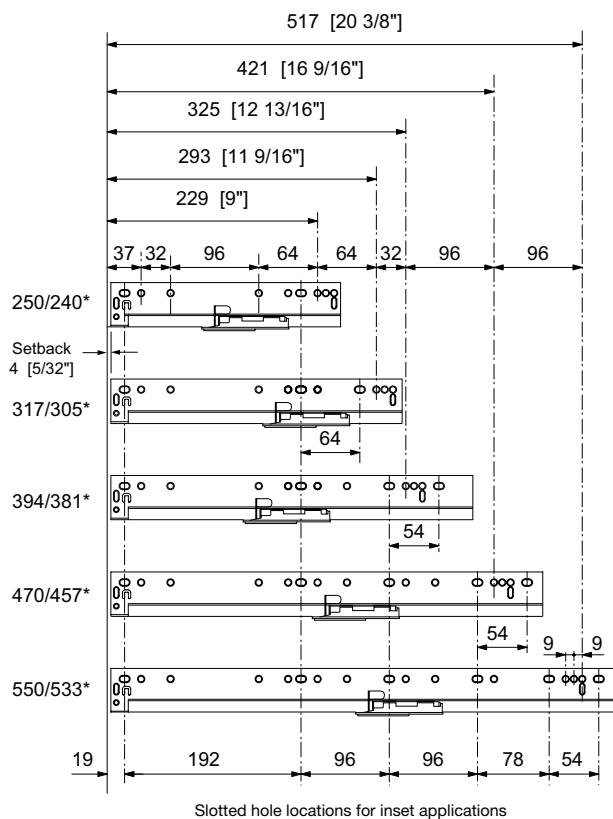

*Cabinet member length / Drawer length (mm)

Reference #	Drawer Length	Interior Cabinet Depth with Universal Bracket	
		Minimum*	Maximum
7523-19/250/240	240 [9 5/8"]	259 [10 1/8"]	296 [11 5/8"]
7523-19/317/305	305 [12"]	329 [12 15/16"]	363 [14 5/16"]
7523-19/394/381	381 [15"]	407 [16"]	440 [17 5/16"]
7523-19/470/457	457 [18"]	479 [18 7/8"]	516 [20 3/8"]
7523-19/550/533	533 [21"]	562 [22 1/8"]	596 [23 3/8"]

*For frameless applications, deduct 1.5 [1/16"] for minimum interior cabinet depth.

Face Frame Applications

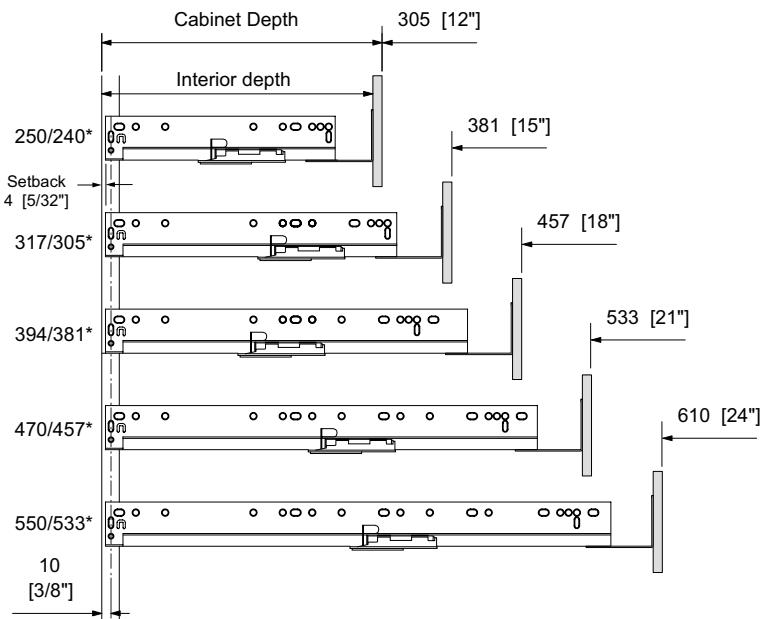

Subject to technical modifications without notice.

Grass Elite Plus

V-notch Rear Mounting Brackets for face frame cabinetry and drilling template

Rear Mounting Brackets, 19mm

- Side-to-side adjustment ± 6 [$\pm 1/4$ "]

Description	Side	Item #	Box Qty.
V-notch, metal, no socket	Left	02212-12	200
	Right	02213-12	200
V-notch, metal, with socket	Left	02216-12	200
	Right	02217-12	200
	Left	02216-03	5
	Right	02217-03	5

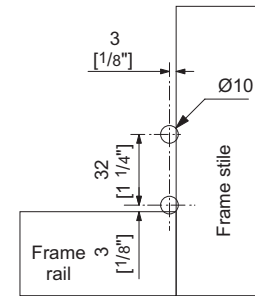
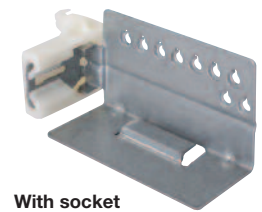
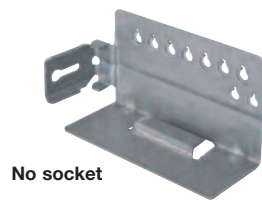

Rear Mounting Brackets, 24mm

- Side-to-side adjustment ± 6 [$\pm 1/4$ "]

Description	Side	Item #	Box Qty.
V-notch, metal, with socket	Left	02226-12	200
	Right	02227-12	200

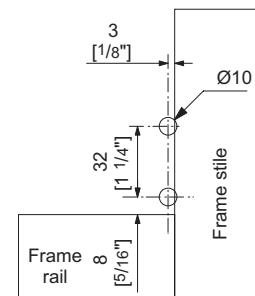
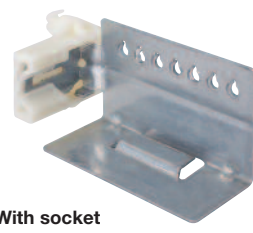

Rear Mounting Brackets, 31.2mm

- Side-to-side adjustment ± 6 [$\pm 1/4$ "]

Description	Side	Item #	Box Qty.
V-notch, metal, no socket	Left	02220-12	200
	Right	02221-12	200
Socket	Non-handed	03274-12	200

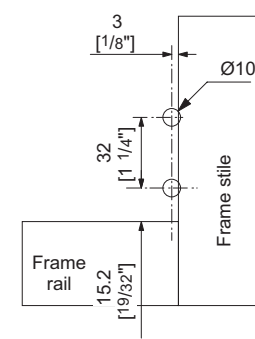
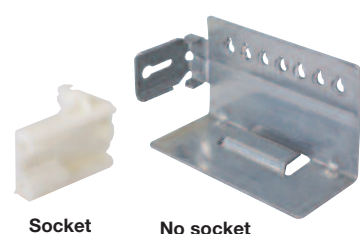

Drilling template

The Elite Plus drilling template is used to precisely bore the holes in the drawer back that receive the rear hook on the slide. Use with a standard 1/4" drill bit and stop collar.

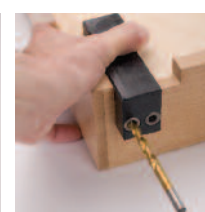

Left side drilling

Right side drilling

Description	Item #	Box Qty.
Elite Plus drilling template	02511-01	1



G*GRASS®

www.grassusa.com



G*GRASS®

»» eliteplus

Grass America Inc.
1202 Highway 66 South
Kernersville, NC 27284

Phone 1-800-334-3512
Fax 1-800-525-8406

Internet: www.grassusa.com
E-Mail: info@grassusa.com

Grass Canada Inc.
475 Finchdene Square, Unit 9
Toronto, ON M1X 1B7

Phone 1-800-461-4975
Fax 1-416-335-5907

Internet: www.grassusa.com
E-Mail: info@grassusa.com