



EZ-LOC

1210-10W



Tools Needed

Measuring tape	Pencil	T10 torx drive bit
Laser level (optional)	Impact driver	#1 square drive bit
Level	T25 torx drive bit	Drill
Stud finder		

Parts Included

[2] Shelf bracket arms	[2] 1.5" self-tapping trim screws
[2] Base plates	[2] 1" self-tapping trim screws
[4] Cabinet screws	[1] 5/32" drill bit
[4] 1-5/8" trim screws	

Installation Instructions

Step 1: Using a laser level or level as a guide, draw a horizontal line on the selected wall or area at the desired installation height taking into account the thickness of the shelf. The line must be as long as the shelf that's being installed.

Step 2: Use a stud finder to find wall studs to mount your brackets on within the length of the horizontal line. Use a pencil to draw a vertical line in the center of each stud up 1" from the horizontal line.

Step 3: Place the provided adhesive mounting template on the wall where the shelf bracket will be fastened. The top edge of the template should be on the horizontal line and the vertical center line should match the vertical line on the wall.

Step 4: With an impact and a T25 drive bit, drive a cabinet screw into the lower indicator on the mounting template, leaving approximately 1/8" between the head of the screw and the wall.

Step 5: Fit the base plate on the lower screw and drive the top screw through the upper hole in the base plate.

Step 6: Lock the shelf bracket arm into the base plate.

Step 7: To level the bracket, place a level on top of the bracket arm and, using an impact with a T25 bit, rotate the bottom screw clockwise or counter-clockwise. Pitch the bracket arm up slightly to compensate for the weight of the shelf. Make sure to level the brackets with each other.

Step 8: With an impact and T10 drive bit, drive the 1-5/8" trim screws into the lower two holes in the base plate.

Repeat steps 3-8 for each shelf bracket.

Step 9: Slide the shelf onto the shelf brackets and push it firmly against the wall. Measure 2" out from the lines drawn in step 2 and use a drill with the 5/32" bit to drill to, but not through, the brackets. Use an impact with a #1 square drive bit to drive a 1" self-tapping screw (for shelves with 1/2" top thickness) or a 1.5" self-tapping screw (for shelves with more than 1/2" top thickness) through each hole and into the brackets to secure the shelf to the wall.

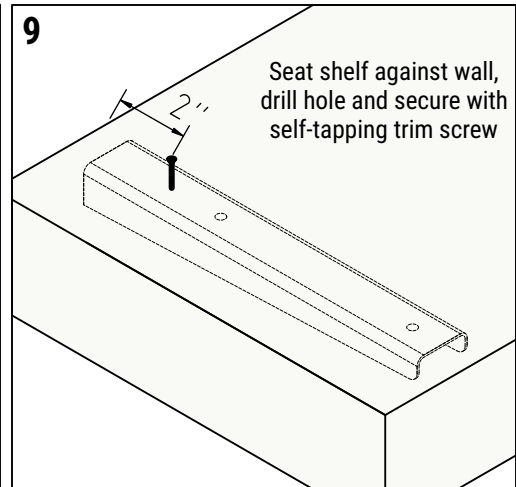
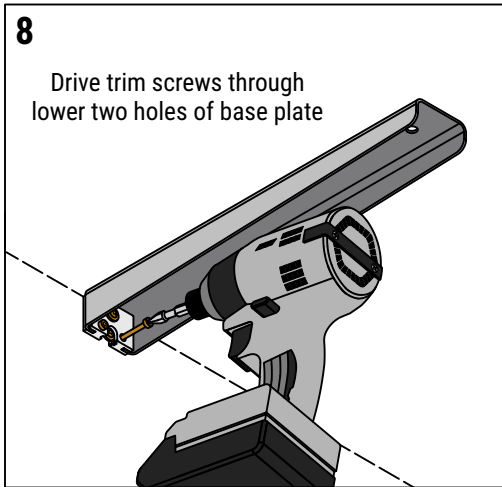
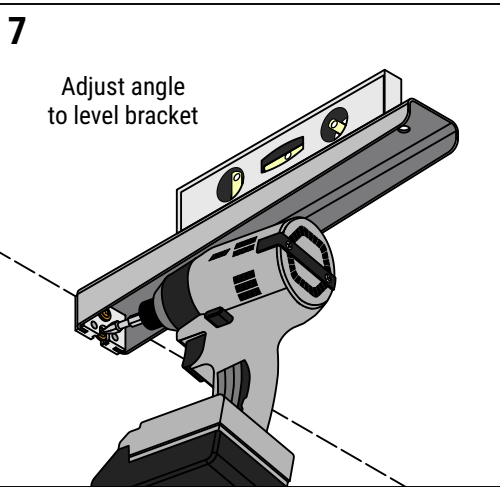
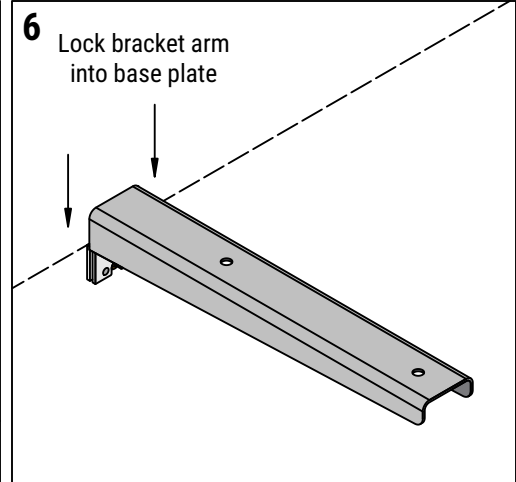
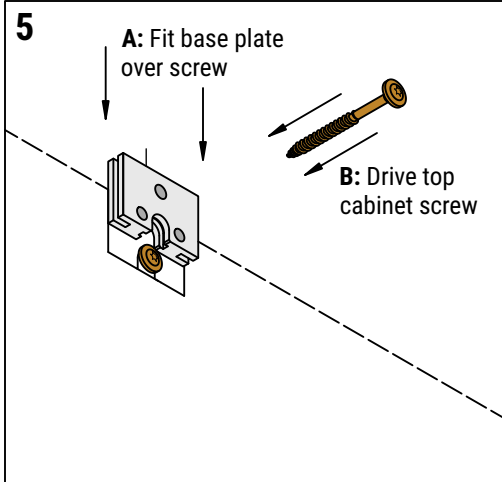
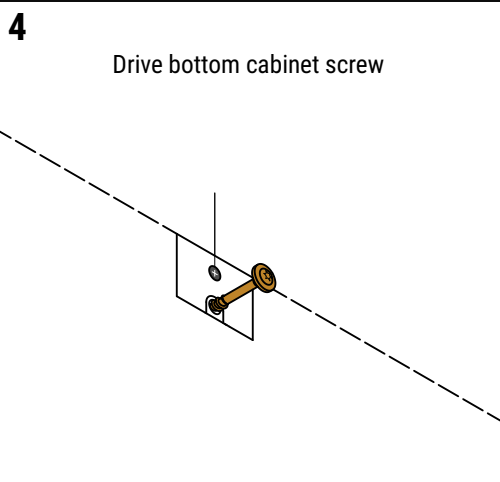
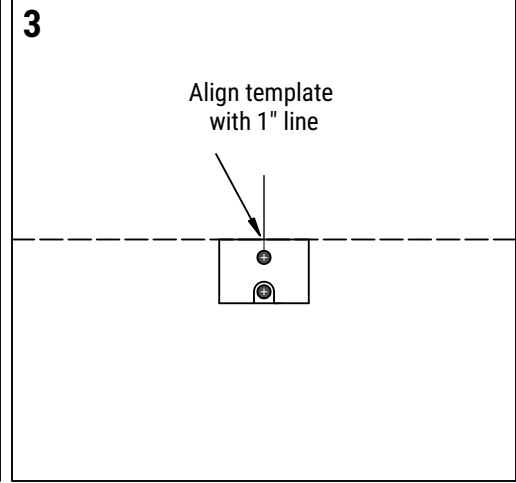
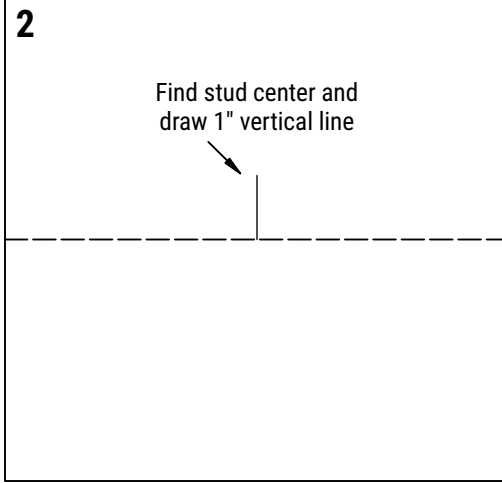
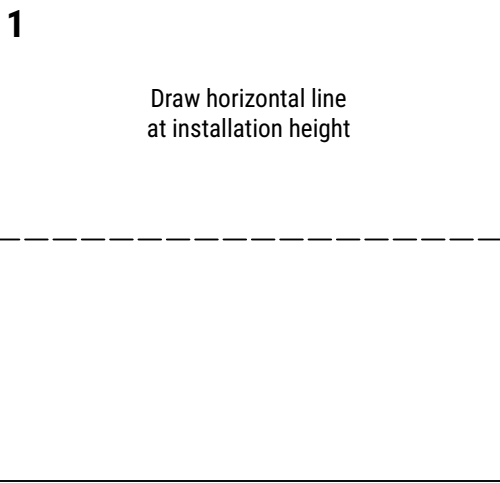

Discover more products by visiting us online. Just scan this **QR code** or visit **www.innovashelf.com** to find inspiration photos, bracket specs, other products, and information about purchasing more brackets or buying wholesale.